

2024

Mayor
CERAMICA 1958

Mayor
CERÁMICA

ÍNDICE POR PAGINACIÓN

INDEX BY PAGINATION

04. Sobre Cerámica Mayor About Cerámica Mayor	21. Colecciones Collections	215. Gres porcelánico espesorado de 20MM 20MM thick porcelain stoneware
16. Ventajas Advantages	23. Crosscut	221. Soluciones para piscinas Pool solutions
17. Simbología Symbology	35. Savoy	232. Creta
18. Lectura del catálogo Reading the catalogue	49. Iconic	234. Samoa
	61. Lao	236. Maui
	75. Cupira	238. Bora
	89. Salem	240. Aruba
	101. Coralina	242. Rejillas de drenaje Drain grates
	113. Calacatta	252. Media caña Trim
	125. Eterna	
	137. Stromboli	
	151. Cements	
	165. Amazonia	
	177. Woods	
	189. Tropic	
	199. Bali	
	207. Volcanic	

256. Recomendaciones de montaje Placement recommendations	258. Colocación de piezas cerámicas en piscinas Ceramic pieces placement in pools	260. Sistema Block 25 Block 25 system
	262. Procedimiento para la colocación y el mantenimiento Procedure for placement and maintenance	264. Dimensiones de las piezas Pieces dimensions
	265. Información técnica Technical information	266. Información embalaje Packing data
	270. Resumen colecciones Collections overview	

ÍNDICE POR FORMATO

INDEX BY FORMAT

Estándar Standard	Pavimento 20MM Pavement 20MM	Pequeño formato Small format
120x120CM 48"x48"	90x90x2CM 36"x36"x0.8"	14.7x14.7CM 5.8"x5.8"
49. Iconic	35. Savoy	75. Cupira
89. Salem	89. Salem	189. Tropic
90x90CM 36"x36"	60x120x2CM 24"x48"x0.8"	199. Bali
23. Crosscut	23. Crosscut	207. Volcanic
35. Savoy	137. Stromboli	
61. Lao	137. Stromboli	
89. Salem	151. Cements	
101. Coralina	151. Cements	
60x120CM 24"x48"	20x120CM 8"x48"	
23. Crosscut	60x60CM 24"x24"	
35. Savoy	23. Crosscut	
49. Iconic	165. Amazonia	
61. Lao	177. Woods	
75. Cupira	89. Salem	
	101. Coralina	
	137. Stromboli	
	165. Amazonia	
	177. Woods	
	89. Salem	
	101. Coralina	
	137. Stromboli	
	151. Cements	
	151. Cements	
	177. Woods	
	89. Salem	
	101. Coralina	
	137. Stromboli	
	151. Cements	
	151. Cements	
	177. Woods	
	89. Salem	
	101. Coralina	
	137. Stromboli	
	151. Cements	
	151. Cements	
	177. Woods	
	89. Salem	
	101. Coralina	
	137. Stromboli	
	151. Cements	
	151. Cements	
	177. Woods	
	89. Salem	
	101. Coralina	
	137. Stromboli	
	151. Cements	
	151. Cements	
	177. Woods	
	89. Salem	
	101. Coralina	
	137. Stromboli	
	151. Cements	
	151. Cements	
	177. Woods	
	89. Salem	
	101. Coralina	
	137. Stromboli	
	151. Cements	
	151. Cements	
	177. Woods	
	89. Salem	
	101. Coralina	
	137. Stromboli	
	151. Cements	
	151. Cements	
	177. Woods	
	89. Salem	
	101. Coralina	
	137. Stromboli	
	151. Cements	
	151. Cements	
	177. Woods	
	89. Salem	
	101. Coralina	
	137. Stromboli	
	151. Cements	
	151. Cements	
	177. Woods	
	89. Salem	
	101. Coralina	
	137. Stromboli	
	151. Cements	
	151. Cements	
	177. Woods	
	89. Salem	
	101. Coralina	
	137. Stromboli	
	151. Cements	
	151. Cements	
	177. Woods	
	89. Salem	
	101. Coralina	
	137. Stromboli	
	151. Cements	
	151. Cements	
	177. Woods	
	89. Salem	
	101. Coralina	
	137. Stromboli	
	151. Cements	
	151. Cements	
	177. Woods	
	89. Salem	
	101. Coralina	
	137. Stromboli	
	151. Cements	
	151. Cements	
	177. Woods	
	89. Salem	
	101. Coralina	
	137. Stromboli	
	151. Cements	
	151. Cements	
	177. Woods	
	89. Salem	
	101. Coralina	
	137. Stromboli	
	151. Cements	
	151. Cements	
	177. Woods	
	89. Salem	
	101. Coralina	
	137. Stromboli	
	151. Cements	
	151. Cements	
	177. Woods	
	89. Salem	
	101. Coralina	
	137. Stromboli	
	151. Cements	
	151. Cements	
	177. Woods	
	89. Salem	
	101. Coralina	
	137. Stromboli	
	151. Cements	
	151. Cements	
	177. Woods	
	89. Salem	
	101. Coralina	
	137. Stromboli	
	151. Cements	
	151. Cements	
	177. Woods	
	89. Salem	
	101. Coralina	
	137. Stromboli	
	151. Cements	
	151. Cements	
	177. Woods	
	89. Salem	
	101. Coralina	
	137. Stromboli	
	151. Cements	
	151. Cements	
	177. Woods	
	89. Salem	
	101. Coralina	
	137. Stromboli	
	151. Cements	
	151. Cements	
	177. Woods	
	89. Salem	
	101. Coralina	
	137. Stromboli	
	151. Cements	
	151. Cements	
	177. Woods	
	89. Salem	
	101. Coralina	
	137. Stromboli	
	151. Cements	
	151. Cements	
	177. Woods	
	89. Salem	
	101. Coralina	
	137. Stromboli	
	151. Cements	
	151. Cements	
	177. Woods	
	89. Salem	
	101. Coralina	
	137. Stromboli	
	151. Cements	
	151. Cements	
	177. Woods	
	89. Salem	
	101. Coralina	
	137. Stromboli	
	151. Cements	
	151. Cements	
	177. Woods	
	89. Salem	
	101. Coralina	
	137. Stromboli	
	151. Cements	
	151. Cements	
	177. Woods	
	89. Salem	
	101. Coralina	
	137. Stromboli	
	151. Cements	
	151. Cements	
	177. Woods	
	89. Salem	
	101. Coralina	
	137. Stromboli	
	151. Cements	
	151. Cements	
	177. Woods	
	89. Salem	
	101. Coralina	
	137. Stromboli	
	151. Cements	
	151. Cements	
	177. Woods	
	89. Salem	
	101. Coralina	
	137. Stromboli	
	151. Cements	
	151. Cements	
	177. Woods	
	89. Salem	
	101. Coralina	
	137. Stromboli	
	151. Cements	
	151. Cements	
	177. Woods	
	89. Salem	
	101. Coralina	
	137. Stromboli	
	151. Cements	
	151. Cements	
	177. Woods	
	89. Salem	
	101. Coralina	
	137. Stromboli	
	151. Cements	
	151. Cements	
	177. Woods	
	89. Salem	
	101. Coralina	
	137. Stromboli	
	151. Cements	
	151. Cements	
	177. Woods	
	89. Salem	
	101. Coralina	
	137. Stromboli	
	151. Cements	
	151. Cements	
	177. Woods	
	89. Salem	
	101. Coralina	
	137. Stromboli	
	151. Cements	
	151. Cements	
	177. Woods	
	89. Salem	
	101. Coralina	
	137. Stromboli	
	151. Cements	
	151. Cements	
	177. Woods	
	89. Salem	
	101. Coralina	
	137. Stromboli	
	151. Cements	
	151. Cements	
	177. Woods	
	89. Salem	
	101. Coralina	
	137. Stromboli	
	151. Cements	
	151. Cements	
	177. Woods	
	89. Salem	
	101. Coralina	
	137. Stromboli	
	151. Cements	
	151. Cements	
	177. Woods	
	89. Salem	
	101. Coralina	
	137. Stromboli	
	151. Cements	
	151. Cements	
	177. Woods	
	89. Salem	
	101. Coralina	
	137. Stromboli	
	151. Cements	
	151. Cements	
	177. Woods	
	89. Salem	
	101. Coralina	
	137. Stromboli	
	151. Cements	
	151. Cements	
	177. Woods</	

4 **Somos tradición,
inconformismo, valentía.
We are tradition,
non-conformism, courage.**



5

Cerámica Mayor S.A. es una empresa líder en la fabricación de material extrusionado con una larga tradición en la producción de pavimentos y piezas especiales, tanto en acabado natural como esmaltado. La empresa fue fundada en el siglo pasado por D. Fernando Mayor Boluda y hoy en día es dirigida por los hermanos Mayor.

Desde sus inicios ha mantenido intactos sus valores, creencias y costumbres, transmitiéndolas de generación en generación y aplicándolas a todas y cada una de sus formas de expresión con inconformismo y valentía, partiendo de la base de materiales que nos aporta la naturaleza para transformarlos, con creatividad, en algo único. Siempre un paso más allá.

Cerámica Mayor S.A. is a leading company in the manufacture of extruded material with a long tradition in the production of pavements and special pieces, both in natural and glazed finish. The company was founded in the last century by D. Fernando Mayor Boluda and today it is directed by the Mayor brothers.

Since its inception, it has kept its values, beliefs and customs intact, transmitting them from generation to generation and applying them to each and every form of expression with non-conformism and courage, starting from the base of materials provided by nature to transform them, with creativity, into something unique. Always a step further.



6 Somos una empresa familiar que cuenta con el saber hacer de cuatro generaciones. De la primera heredamos el conocimiento de la materia prima, las arcillas, el fuego, pasando por la generación emprendedora que acogió la empresa como un punto de inflexión entre lo viejo y lo nuevo, cambiando el concepto de empresa manual a una fábrica con la última tecnología y nuevos desarrollos.

La última y más reciente generación continúa con el legado ahora potenciando cada día un producto exclusivo con las mejores materias primas y los procesos industriales más conservadores con el medioambiente.

Un viaje por el saber hacer de cuatro generaciones desde el origen de la materia hasta la confección final de un producto contemporáneo imperdurable en el tiempo.

We are a family business with the know-how of four generations. From the first generation we inherited the knowledge of the raw materials, the clays, the fire, passing through the enterprising generation that took the company as a turning point between the old and the new, changing the concept of a manual company to a factory with the latest technology and new developments.

The latest and most recent generation continues with the legacy now promoting every day an exclusive product with the best raw materials and the most environmentally friendly industrial processes.

A journey through the know-how of four generations from the origin of the material to the final manufacture of a contemporary product that is timeless.



El viaje por la experiencia de cuatro generaciones vivaces y perfeccionistas.
The journey through the experience of four lively and perfectionist generations.

**El sentimiento de
un equipo unido.
The feeling of a
united team.**

Actualmente somos un equipo de más de 120 personas que trabajamos con profesionalidad y perseverancia para lograr un objetivo común: la excelencia en nuestros productos. Nuestro departamento técnico, experto en arquitectura, ingeniería, construcción y diseño, se involucra en cada proyecto, desde el planteamiento hasta su finalización, creando sinergias con cada cliente a lo largo de todo el proceso con el objetivo de lograr la excelencia en el producto.

Currently we are a team of 120 people working with professionalism and perseverance to achieve a common goal: the excellence of our products. Our technical department, specialized in architecture, engineering, construction and design, is involved in each project, from the approach until its completion, creating synergies with each customer throughout the whole process with the aim of achieving product excellence.





**La incansable búsqueda
de la excelencia en
nuestros productos.
The relentless pursuit
of excellence in our
products.**







La búsqueda constante de la perfección y la pureza en nuestros productos nos lleva a someter a todas nuestras piezas a rigurosos controles de calidad en todo el proceso de producción.

Se prueban entre otras cosas la resistencia mecánica y a choques térmicos, la resistencia química del esmalte, la pureza de sus componentes y la estabilidad de sus formas. Un control de calidad integral, desde la selección de las arcillas hasta el embalaje final para asegurar que el producto final haga eco de la visión exigente, creativa y sostenible de Cerámica Mayor.

The constant search for perfection and purity in our products leads us to subject all our pieces to rigorous quality controls throughout the production process.

Among other things, we test the mechanical and thermal shock resistance, the chemical resistance of the glaze, the purity of its components and the stability of its shapes. A comprehensive quality control, from the selection of the clays to the final packaging to ensure that the final product echoes the demanding, creative and sustainable vision of Cerámica Mayor.



- 
Nuestras baldosas y piezas especiales están compuestas por un 50% de material reciclado
 Our tiles and special pieces are made of 50% recycled material
- 
El 60% del packaging es sostenible o biodegradable
 60% of packaging is sustainable or biodegradable
- 
El 100% del material descartado en el proceso es reincorporado
 100% of the material discarded in the process is reincorporated
- 
Evitamos la emisión de partículas a la atmósfera
 We avoid the emission of particulate matter into the atmosphere
- 
El 100% del agua utilizada en el proceso es reincorporada
 100% of the water used in the process is reincorporated
- 
Creamos un desperdicio 0 utilizando la técnica de las 3 "R": Reutilizar, Reducir, Reciclar
 We create 0 waste using the 3Rs: Reuse, Reduce, Recycle
- 
Con el empleo de placas solares evitamos la emisión de toneladas de CO₂ a la atmósfera
 Using solar panels we avoid the emission of tons of CO₂ into the atmosphere

Nuestras colecciones son un tributo a la naturaleza.
Somos conscientes y sostenibles.
Our collections are a tribute to nature.
We are conscious and sustainable.

La conservación y el respeto del entorno natural y medioambiental forma parte de los condicionantes de nuestro proceso industrial.

Nuestro pavimento se compone de un 50% de material reciclado. Recuperamos el 100% de los residuos generados y reincorporamos el 100% del agua utilizada en el proceso asegurando un vertido cero. Todos los eslabones de la cadena productiva están pensados para facilitar el reciclado de los materiales.

The conservation and respect of the natural and environmental surroundings is part of the conditioning factors of our industrial process.

Our paving is made up of 50% recycled material. We recover 100% of the waste generated and reincorporate 100% of the water used in the process ensuring zero waste. All the links in the production chain are designed to facilitate the recycling of materials.



**No pensamos en pequeño,
soñamos en grande.
We don't think small,
we dream big.**



Nuestro proyecto de futuro es una rotunda apuesta para afrontar los nuevos retos que demanda el mercado en cuanto a arquitectura sostenible y eficiencia en nuestra producción, con nuevos centros logísticos, se refiere.

La nueva forma de proyectar y construir edificios pasa, sin lugar a dudas, por lograr una edificación que respete el entorno natural y mejore la calidad de vida, desde el propio proceso de producción, reincorporando el agua propiciando un vertido cero, hasta elementos como techados solares, nuestra incansable búsqueda de nuevas aplicaciones y el estudio de los materiales, junto con el espíritu de nuestro equipo, hacen de nosotros una empresa altamente cualificada para dar respuesta a las necesidades de la arquitectura bioclimática del futuro.

Our project for the future is a resounding commitment to meet the new challenges demanded by the market in terms of sustainable and efficient architecture in our production with new logistics centres.

The new way of designing and constructing buildings is undoubtedly to achieve a building that respects the natural environment and improves the quality of life, from the production process itself, reincorporating water, promoting zero waste, to elements such as solar roofing, our tireless search for new applications and the study of materials, together with the spirit of our team, make us a highly qualified company to respond to the needs of the bioclimatic architecture of the future.



VENTAJAS

ADVANTAGES



Resistencia a la flexión
Bending strength



Resistencia a la helada
Frost resistance



Ecológico
Ecological



Resistencia química
Chemical resistance



Ignífugo
Fire resistance



Máxima resistencia al fuego y al calor
Maximum fire and heat resistance



Resistencia al rayado
Scratch resistance



Color duradero
Durable colour



Fácil limpieza y mínimo mantenimiento
Easy to clean and minimum maintenance



Resistencia al choque térmico
Thermal impact resistance



Antiestático
Antistatic



Multiformato
Multi-format



Resistencia a la abrasión
Abrasion resistance



Baja absorción
Low absorption



Piezas especiales
Special pieces



Resistencia al desgaste
Wear resistance



Durabilidad
Durability



Resistencia a los rayos UV
UV resistance



Resistencia a las manchas
Stain resistance



Fácil colocación
Easy to install



Antideslizante para exteriores
Non-slip for outdoor use

SIMBOLOGÍA

SYMBOLOLOGY



Tamaño de la base
Tile size



Piezas y bases de exterior Clase 3
Outdoor pieces and tiles Class 3



Piezas y bases de interior R9
Indoor pieces and tiles R9

MONOBLOCK

Fabricado de una pieza, sin pegado
Made in one piece, not glued



Porcentaje de desbordamiento
Percentage of overflow



Antideslizante Clase 1
Non-slip Class 1



Producto de fácil limpieza
Easy clean product



EN ISO 10545-12



Empresa vinculada a Tile of Spain
Tile of Spain vinculated enterprise



Certificado de gestión de sistemas IQNET
Management system certificated IQNET

60x120cm 24"x48"

Tamaño en centímetros
Size in centimetres



Piezas y bases de interior Clase 1
Indoor pieces and tiles Class 1



Bases rectificadas
Rectified tiles



Sistema con goma de amortiguación
Rubber cushioning system



Esmaltado a 3 caras
Enamelled on 3 sides



Antideslizante Clase 3
Non-slip Class 3



EN ISO 10545-13
GA / GLA / GHA



EN 16165
R11



Certificado ISO 9001 por AENOR
Certificated ISO 9001 by AENOR



Empresa vinculada a ASCER
ASCER vinculated enterprise

60x120cm 24"x48"

Tamaño en pulgadas
Size in inches



Piezas y bases de exterior R11
Outdoor pieces and tiles R11



Grosor de la base
Tile thickness



Patente mundial de la pieza
Worldwide patent of the piece



Grosor lateral peldaño
Step side thickness



Larga vida
Long life



EN 16165
Clase 3



EN 16165
Clase C



Certificado de baldosas sostenibles
Sustainable tiles certificated



Declaración Ambiental de Producto
Environmental Product Declaration

LECTURA DEL CATÁLOGO

READING THE CATALOGUE

01.
Nombre de la colección
Collection name

02.
Colores disponibles
Available colours

03.
Formatos disponibles
Available formats

04.
Información embalaje
Packing data

05.
Colores recomendados para la junta
Recommended joint colours

06.
Piezas especiales
Special pieces

07.
Sistema de piscina
Pool system

08.
Colores disponibles de la pieza especial
Available colours of the special piece

09.
Posibilidades de colocación
Placement possibilities

10.
Características técnicas
Technical information

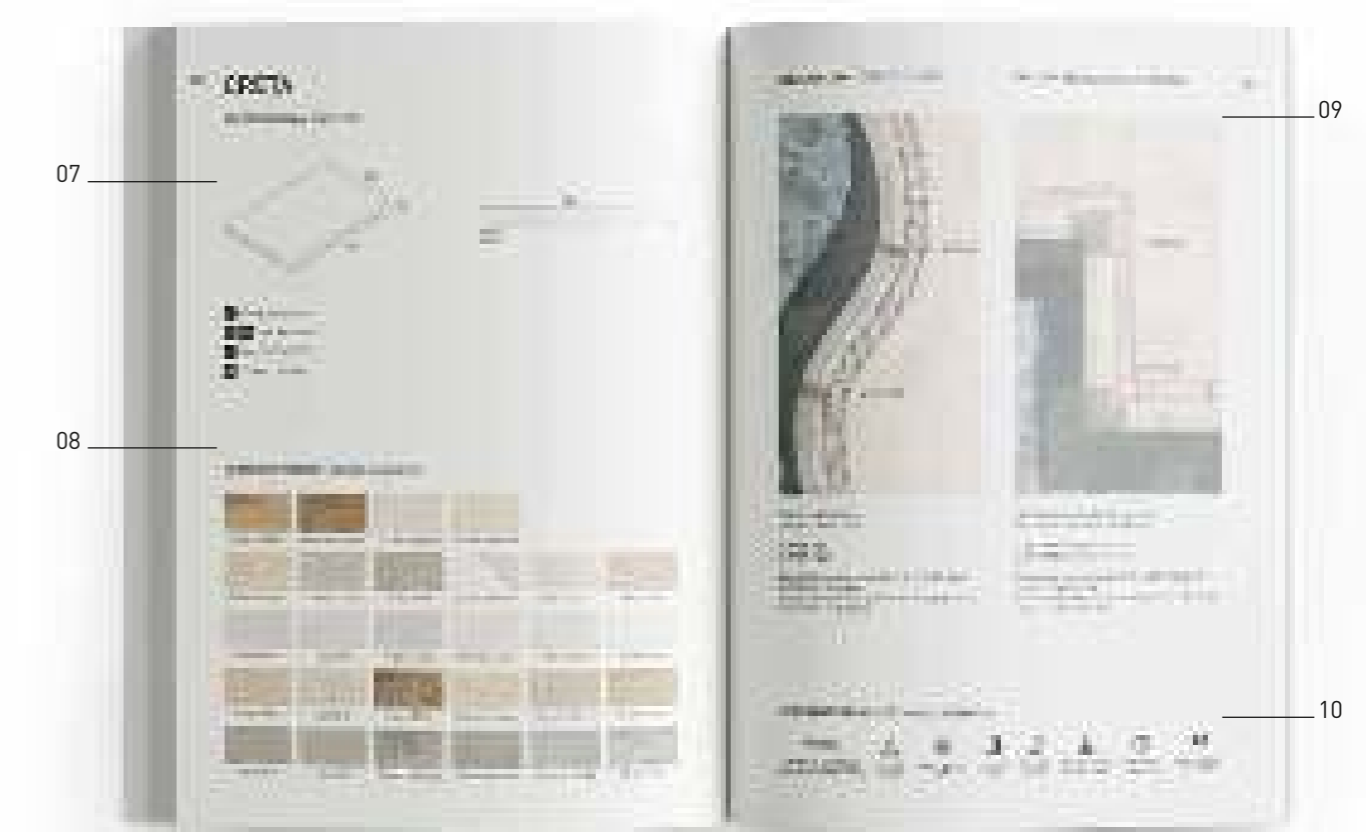
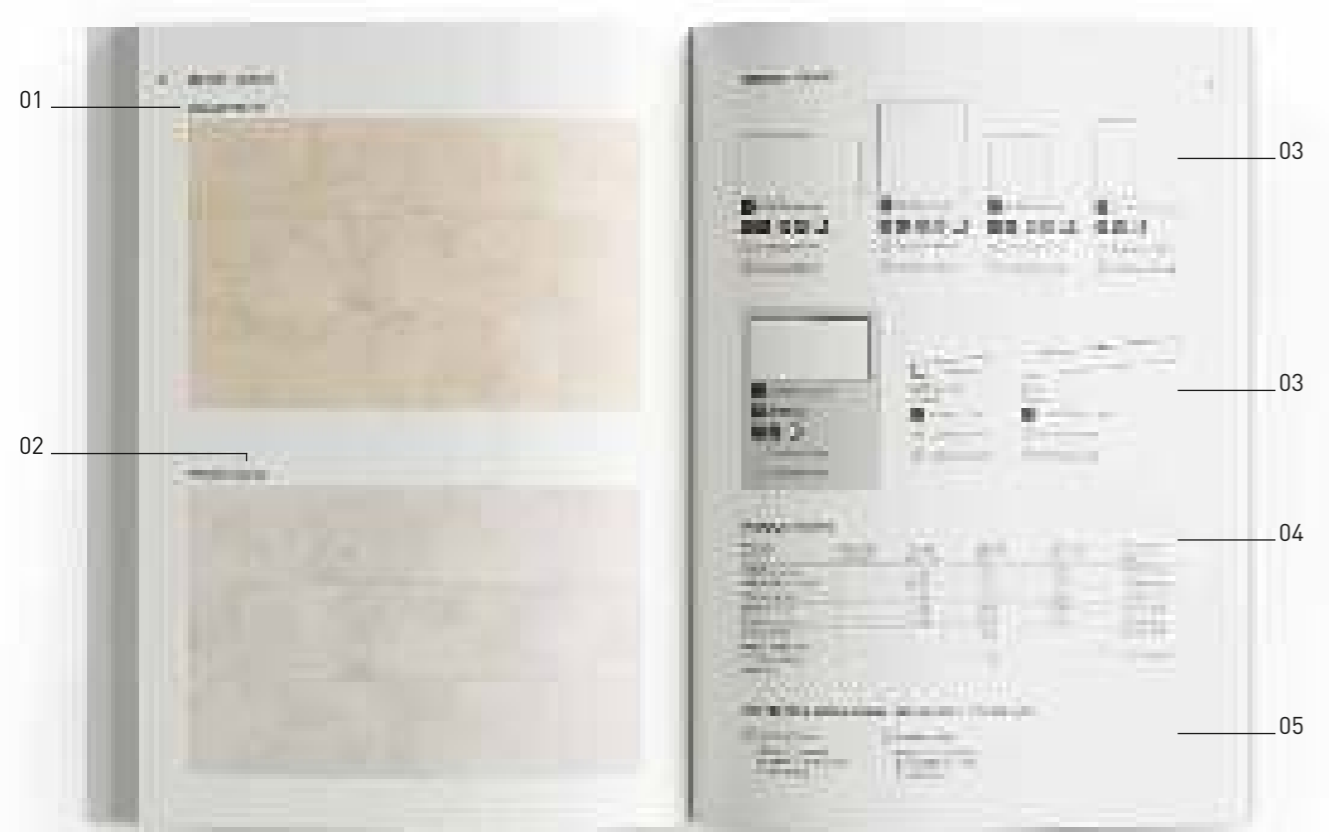



COLECCIÓN
COLLECTION

CROSSCUT





CROSSCUT PETRA



CROSSCUT CLOUD



FORMATOS · FORMATS

↗ 60x120cm 24"x48"	↗ 90x90cm 36"x36"	↗ 60x60cm 24"x24"	↗ 37.5x75cm 15"x30"
C3 R11 · C1 R9 ·	C3 R11 · C1 R9 ·	C3 R11 · C1 R9 ·	C3 R11 ·
Crosscut Petra	Crosscut Petra	Crosscut Petra	Crosscut Petra
Crosscut Cloud	Crosscut Cloud	Crosscut Cloud	Crosscut Cloud

↗ 60x120cm 24"x48"	Rodapié Skirting board	Tabica Riser
↕ 20MM 0.8"	↗ 9x60cm 3.5"x24"	↗ 14.5x120cm 5.7"x48"
C3 R11 ·	Crosscut Petra	Crosscut Petra
Crosscut Petra	Crosscut Cloud	Crosscut Cloud
Crosscut Cloud		

EMBALAJE · PACKING



Formatos Formats	piezas / caja pieces / box	m ² / caja sqm / box	kg / caja kg / box	sqm / palet m ² / pallet	tamaño palet pallet size
60x120 ^R cm 24"x48"	2	1,4400	31,65	46,08	120x84x74cm
60x120 ^R 2CM 24"x48"x0.8"	1	0,7200	34,37	19,44	120x84x74cm
90x90 ^R cm 36"x36"	2	1,6200	32,50	48,60	106x95x74cm
60x60 ^R cm 24"x24"	4	1,4400	27,00	46,08	120x80x74cm
37.5x75 ^R cm 15"x30"	4	1,1250	23,50	61,87	120x80x89cm
9x60cm 3.5"x24"	10	-	15,36	-	110x95x96cm
Rodapié · Skirting board					
14.5x120cm 5.7"x48"	6	-	22,20	-	125x110x90cm
Tabica · Riser					

COLORES JUNTA RECOMENDADOS · RECOMMENDED JOINT COLOURS

Crosscut Petra	Crosscut Cloud
Mapei 130 Jasmine Kerakoll 31 Beige Dakar Litokol Ivory 2	Mapei 111 Silver Grey Kerakoll 03 Gris Perla Litokol Silver 1



Peldaño recto · Recto step



- ↗ 33x120cm 13"x48"
- C3** **R11** · **C1** **R9**
-  Crosscut Petra
-  Crosscut Cloud



Peldaño recto tapa · Recto step corner



- ↗ 33x120cm 13"x48"
- C3** **R11** · **C1** **R9**
-  Crosscut Petra
-  Crosscut Cloud



Peldaño completo · Full step



- ↗ 33x120cm 13"x48"
- C3** **R11**
-  Crosscut Petra
-  Crosscut Cloud



Borde Creta · Creta edge



- ↗ 33x50cm 13"x19.7"
- C3** **R11**
-  Crosscut Petra
-  Crosscut Cloud



Borde Maui · Maui edge



- ↗ 33x50cm 13"x19.7"
- C3** **R11**
-  Crosscut Petra
-  Crosscut Cloud



Borde Bora · Bora edge



- ↗ 20x50cm 8"x19.7"
- C3** **R11**
-  Crosscut Petra
-  Crosscut Cloud



Borde Aruba · Aruba edge



- ↗ 25x50cm 10"x19.7"
- C3** **R11**
-  Crosscut Petra
-  Crosscut Cloud

Borde Samoa · Samoa edge



- ↗ 50x120cm 19.7"x48"
- C3** **R11**
-  Crosscut Petra
-  Crosscut Cloud

Rejilla de drenaje RJ20 · Drain grate RJ20



↗ 20x50cm 8"x19.7"



Crosscut Petra

Crosscut Cloud

Desagüe · Drain: >11m³/horaGoma para rejilla 9710 incluida
Grate rubber 9710 included

Rejilla de drenaje RJ20 FLEX · Drain grate RJ20 FLEX



↗ 20x50cm 8"x19.7"



Crosscut Petra

Crosscut Cloud

Desagüe · Drain: >30m³/horaGoma para rejilla 9710 incluida
Grate rubber 9710 included

Rejilla de drenaje RJ25 · Drain grate RJ25



↗ 25x50cm 10"x19.7"



Crosscut Petra

Crosscut Cloud

Desagüe · Drain: >13m³/horaGoma para rejilla 9710 incluida
Grate rubber 9710 included

Rejilla de drenaje RJ25 FLEX · Drain grate RJ25 FLEX

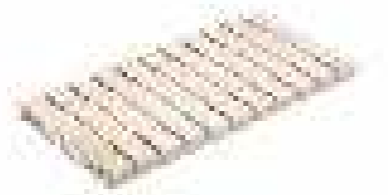

↗ 25x50cm 10"x19.7"



Crosscut Petra

Crosscut Cloud

Desagüe · Drain: >30m³/horaGoma para rejilla 9710 incluida
Grate rubber 9710 included

Rejilla de drenaje RJ25 INV · Drain grate RJ25 INV



↗ 25x50cm 10"x19.7"



Crosscut Petra

Crosscut Cloud

Desagüe · Drain: >8m³/horaGoma para rejilla 12719 incluida
Grate rubber 12719 included

Goma para rejilla 9710 · Grate rubber 9710



Goma para rejilla 12719 · Grate rubber 12719

Media caña exterior
Outer trim

↗ 4.5x50cm 1.8"x19.7"



Crosscut Petra

Crosscut Cloud

Escocia cantonera exterior
Scotch external corner

↗ 4.5x4.5cm 1.8"x1.8"



Crosscut Petra

Crosscut Cloud

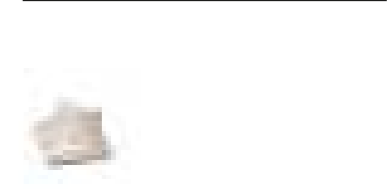
Esquina cantonera exterior
Outer angle corner

↗ 6.5x6.5cm 2.5"x2.5"



Crosscut Petra

Crosscut Cloud

Media caña interior
Inner trim

↗ 5.5x50cm 2.1"x19.7"

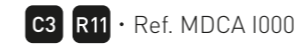

Crosscut Petra

Crosscut Cloud

Escocia cantonera interior
Scotch inner corner

↗ 5.5x5.5cm 2.1"x2.1"

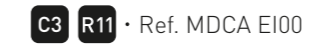

Crosscut Petra

Crosscut Cloud

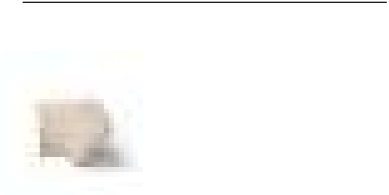
Esquina cantonera interior
Inner angle corner

↗ 6.5x6.5cm 2.5"x2.5"



Crosscut Petra

Crosscut Cloud

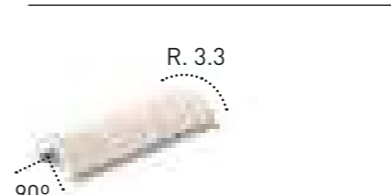
Cantonera transición exterior
External transition corner

↗ 4.5x16cm 1.8"x6.3"



Crosscut Petra

Crosscut Cloud

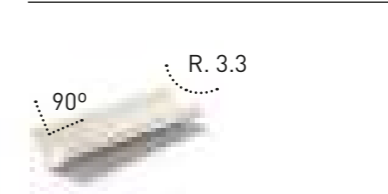
Cantonera transición interior
Inner transition corner

↗ 5.5x16cm 2.1"x6.3"

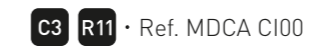

Crosscut Petra

Crosscut Cloud

*Información detallada sobre las
piezas de terminación en las páginas
252 y 253.*Detailed information about trim
pieces in pages 252 and 253.



COLECCIÓN
COLLECTION

SAVOY







SAVOY MOON

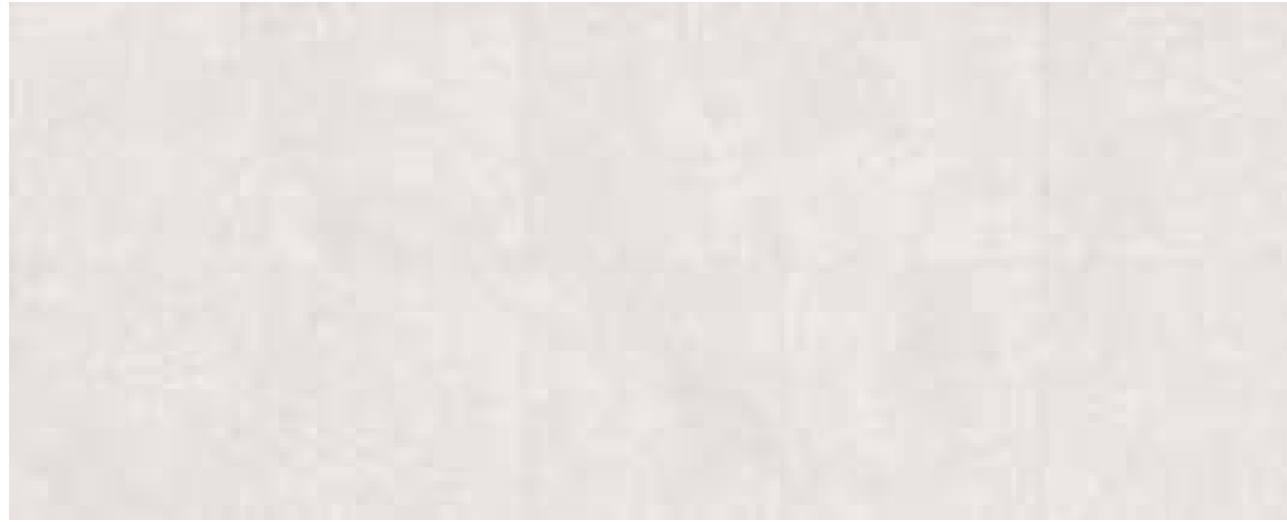

SAVOY DESERT



SAVOY LAND

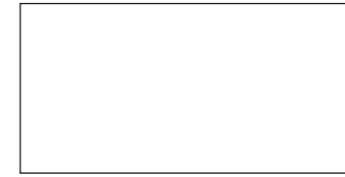

↖ ↗ 60x120cm 24"x48"

C3 R11 · C1 R9 · R

- Savoy Moon
- Savoy Desert
- Savoy Land

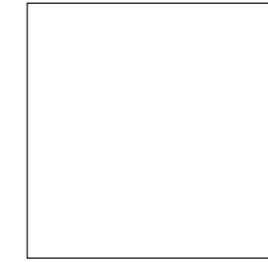

↖ ↗ 90x90cm 36"x36"

C3 R11 · C1 R9 · R

- Savoy Moon
- Savoy Desert
- Savoy Land

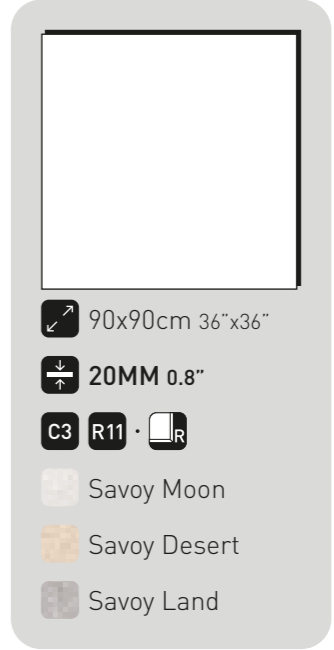

↖ ↗ 90x90cm 36"x36"

↕ 20MM 0.8"

C3 R11 · R

- Savoy Moon
- Savoy Desert
- Savoy Land



Rodapié
Skirting board

↖ ↗ 9x60cm 3.5"x24"

- Savoy Moon
- Savoy Desert
- Savoy Land



Tabica
Riser

↖ ↗ 14.5x120cm 5.7"x48"

- Savoy Moon
- Savoy Desert
- Savoy Land

EMBALAJE · PACKING

Formatos Formats	piezas / caja pieces / box	m ² / caja sqm / box	kg / caja kg / box	m ² / palet sqm / pallet	tamaño palet pallet size
60x120 ^R cm 24"x48"	2	1,4400	31,65	46,08	120x84x74cm
90x90 ^R cm 36"x36"	2	1,6200	32,50	48,60	106x95x74cm
90x90 ^R 2CM 36"x36"x0.8"	1	0,8100	39,00	21,87	105x95x84cm
9x60cm 3.5"x24"	10	-	15,36	-	110x95x96cm
Rodapié · Skirting board					
14.5x120cm 5.7"x48"	6	-	22,20	-	125x110x90cm
Tabica · Riser					

COLORES JUNTA RECOMENDADOS · RECOMMENDED JOINT COLOURS

- | | | |
|--|---|--|
| <ul style="list-style-type: none"> Savoy Moon Mapei 100 White Kerakoll 01 Blanco Litokol White 1 | <ul style="list-style-type: none"> Savoy Desert Mapei 130 Jasmine Kerakoll 31 Beige Dakar Litokol Ivory 3 | <ul style="list-style-type: none"> Savoy Land Mapei 112 Medium Grey Kerakoll 04 Gris Hierro Litokol Silver 2 |
|--|---|--|

Peldaño recto · Recto step



- ↗ 33x120cm 13"x48"
- C3** **R11** · **C1** **R9**
- Savoy Moon
 - Savoy Desert
 - Savoy Land

Peldaño recto tapa · Recto step corner



- ↗ 33x120cm 13"x48"
- C3** **R11** · **C1** **R9**
- Savoy Moon
 - Savoy Desert
 - Savoy Land

Borde Creta · Creta edge



- ↗ 33x50cm 13"x19.7"
- C3** **R11**
- Savoy Moon
 - Savoy Desert
 - Savoy Land

Borde Maui · Maui edge



- ↗ 33x50cm 13"x19.7"
- C3** **R11**
- Savoy Moon
 - Savoy Desert
 - Savoy Land

Rejilla de drenaje RJ25 · Drain grate RJ25



↗ 25x50cm 10"x19.7"



☐ Savoy Moon

☐ Savoy Desert

☐ Savoy Land

Desagüe · Drain: >13m³/hora

Goma para rejilla 9710 incluida
Grate rubber 9710 included

Rejilla de drenaje RJ25 FLEX · Drain grate RJ25 FLEX



↗ 25x50cm 10"x19.7"



☐ Savoy Moon

☐ Savoy Desert

☐ Savoy Land

Desagüe · Drain: >30m³/hora

Goma para rejilla 9710 incluida
Grate rubber 9710 included

Rejilla de drenaje RJ25 INV · Drain grate RJ25 INV



↗ 25x50cm 10"x19.7"



☐ Savoy Moon

☐ Savoy Desert

☐ Savoy Land

Desagüe · Drain: >8m³/hora

Goma para rejilla 12719 incluida
Grate rubber 12719 included

Goma para rejilla 9710 · Grate rubber 9710

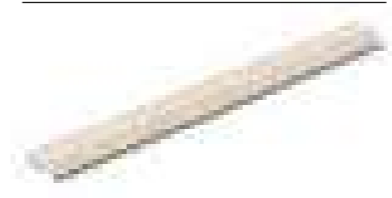

Goma para rejilla 12719 · Grate rubber 12719

Media caña exterior
Outer trim

↗ 4.5x50cm 1.8"x19.7"



☐ Savoy Moon

☐ Savoy Desert

☐ Savoy Land

Escocia cantonera exterior
Scotch external corner

↗ 4.5x4.5cm 1.8"x1.8"

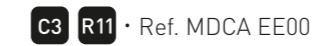

☐ Savoy Moon

☐ Savoy Desert

☐ Savoy Land

Esquina cantonera exterior
Outer angle corner

↗ 6.5x6.5cm 2.5"x2.5"



☐ Savoy Moon

☐ Savoy Desert

☐ Savoy Land

Media caña interior
Inner trim

↗ 5.5x50cm 2.1"x19.7"

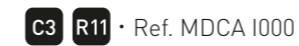

☐ Savoy Moon

☐ Savoy Desert

☐ Savoy Land

Escocia cantonera interior
Scotch inner corner

↗ 5.5x5.5cm 2.1"x2.1"

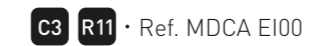

☐ Savoy Moon

☐ Savoy Desert

☐ Savoy Land

Esquina cantonera interior
Inner angle corner

↗ 6.5x6.5cm 2.5"x2.5"



☐ Savoy Moon

☐ Savoy Desert

☐ Savoy Land

Cantonera transición exterior
External transition corner

↗ 4.5x16cm 1.8"x6.3"



☐ Savoy Moon

☐ Savoy Desert

☐ Savoy Land

Cantonera transición interior
Inner transition corner

↗ 5.5x16cm 2.1"x6.3"



☐ Savoy Moon

☐ Savoy Desert

☐ Savoy Land

*Información detallada sobre las piezas de terminación en las páginas 252 y 253.

*Detailed information about trim pieces in pages 252 and 253.



COLECCIÓN
COLLECTION

ICONIC





ICONIC STONE



FORMATOS · FORMATS

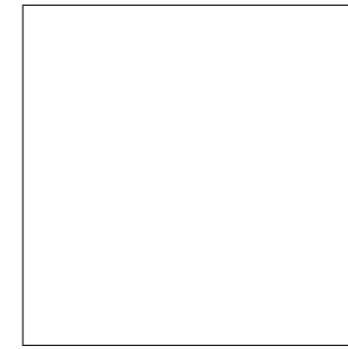

↗ 120x120cm 48"x48"

C3 R11 · C1 R9 · 

 Iconic Stone

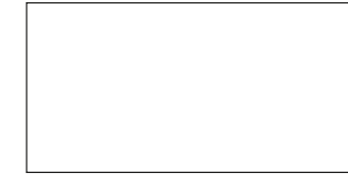

↗ 60x120cm 24"x48"

C3 R11 · C1 R9 · 

 Iconic Stone



Rodapié
Skirting board

↗ 9x60cm 3.5"x24"

 Iconic Stone



Tabica
Riser

↗ 14.5x120cm 5.7"x48"

 Iconic Stone

EMBALAJE · PACKING

Formatos Formats	piezas / caja pieces / box	m ² / caja sqm / box	kg / caja kg / box	m ² / palet sqm / pallet	tamaño palet pallet size
120x120 ^R cm 48"x48"	1	1,4400	31,00	57,60	135x121x58cm
60x120 ^R cm 24"x48"	2	1,4400	31,65	46,08	120x84x74cm
9x60cm 3.5"x24"	10	-	15,36	-	110x95x96cm
Rodapié · Skirting board					
14.5x120cm 5.7"x48"	6	-	22,20	-	125x110x90cm
Tabica · Riser					

COLORES JUNTA RECOMENDADOS · RECOMMENDED JOINT COLOURS

 Iconic Stone

Mapei 110 Manhattan 2000
Kerakoll 04 Gris Hierro
Litokol Grey 1

Peldaño recto · Recto step



↗ 33x120cm 13"x48"
C3 R11 · C1 R9
 Iconic Stone

Peldaño recto tapa · Recto step corner



↗ 33x120cm 13"x48"
C3 R11 · C1 R9
 Iconic Stone

Borde Creta · Creta edge



↗ 33x50cm 13"x19.7"
C3 R11
 Iconic Stone

Rejilla de drenaje RJ25 · Drain grate RJ25



↗ 25x50cm 10"x19.7"

C3 R11 · 🌿 🌍

Iconic Stone

Desagüe · Drain: >13m³/hora

Goma para rejilla 9710 incluida
Grate rubber 9710 included

Rejilla de drenaje RJ25 FLEX · Drain grate RJ25 FLEX



↗ 25x50cm 10"x19.7"

C3 R11 · 🌿 🌍

Iconic Stone

Desagüe · Drain: >30m³/hora

Goma para rejilla 9710 incluida
Grate rubber 9710 included

Goma para rejilla 9710 · Grate rubber 9710

Media caña exterior
Outer trim

↗ 4.5x50cm 1.8"x19.7"

C3 R11 · Ref. MDCA E000

Iconic Stone

Escocia cantonera exterior
Scotch external corner

↗ 4.5x4.5cm 1.8"x1.8"

C3 R11 · Ref. MDCA EE00

Iconic Stone

Esquina cantonera exterior
Outer angle corner

↗ 6.5x6.5cm 2.5"x2.5"

C3 R11 · Ref. MDCA AE00

Iconic Stone

Media caña interior
Inner trim

↗ 5.5x50cm 2.1"x19.7"

C3 R11 · Ref. MDCA I000

Iconic Stone

Escocia cantonera interior
Scotch inner corner

↗ 5.5x5.5cm 2.1"x2.1"

C3 R11 · Ref. MDCA EI00

Iconic Stone

Esquina cantonera interior
Inner angle corner

↗ 6.5x6.5cm 2.5"x2.5"

C3 R11 · Ref. MDCA AI00

Iconic Stone

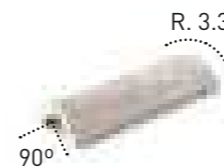
Cantonera transición exterior
External transition corner

↗ 4.5x16cm 1.8"x6.3"

C3 R11 · Ref. MDCA CE00

Iconic Stone

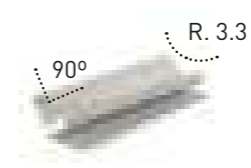
Cantonera transición interior
Inner transition corner

↗ 5.5x16cm 2.1"x6.3"

C3 R11 · Ref. MDCA CI00

Iconic Stone

*Información detallada sobre las piezas de terminación en las páginas 252 y 253.

*Detailed information about trim pieces in pages 252 and 253.



COLECCIÓN
COLLECTION

LAO







LAO BONE



LAO SAND



LAO ASH



FORMATOS · FORMATS

- 60x120cm 24"x48"
 C3 R11 R
 Lao Bone
 Lao Sand
 Lao Ash
- 90x90cm 36"x36"
 C3 R11 C1 R9 R
 Lao Bone
 Lao Sand
 Lao Ash
- 37.5x75cm 15"x30"
 C3 R11 R
 Lao Bone
 Lao Sand
 Lao Ash

- Rodapié
 Skirting board
 9x60cm 3.5"x24"
 Lao Bone
 Lao Sand
 Lao Ash
- Tabica
 Riser
 14.5x120cm 5.7"x48"
 Lao Bone
 Lao Sand
 Lao Ash

EMBALAJE · PACKING

Formatos Formats	piezas / caja pieces / box	m ² / caja sqm / box	kg / caja kg / box	m ² / palet sqm / pallet	tamaño palet pallet size
60x120 ^o cm 24"x48"	2	1,4400	31,65	46,08	120x84x74cm
90x90 ^o cm 36"x36"	2	1,6200	32,50	48,60	106x95x74cm
37.5x75 ^o cm 15"x30"	4	1,1250	23,50	61,87	120x80x89cm
9x60cm 3.5"x24"	10	-	15,36	-	110x95x96cm
Rodapié · Skirting board					
14.5x120cm 5.7"x48"	6	-	22,20	-	125x110x90cm
Tabica · Riser					

COLORES JUNTA RECOMENDADOS · RECOMMENDED JOINT COLOURS

- Lao Bone
 Mapei 100 White
 Kerakoll 01 Blanco
 Litokol White 1
- Lao Sand
 Mapei 130 Jasmine
 Kerakoll 31 Beige Dakar
 Litokol Ivory 2
- Lao Ash
 Mapei 112 Medium Grey
 Kerakoll 04 Gris Hierro
 Litokol Silver 2

Peldaño recto · Recto step



↗ 33x120cm 13"x48"
C3 R11 · C1 R9
 Lao Bone
 Lao Sand
 Lao Ash

Peldaño recto tapa · Recto step corner



↗ 33x120cm 13"x48"
C3 R11 · C1 R9
 Lao Bone
 Lao Sand
 Lao Ash

Borde Creta · Creta edge



↗ 33x50cm 13"x19.7"
C3 R11
 Lao Bone
 Lao Sand
 Lao Ash

Borde Maui · Maui edge



↗ 33x50cm 13"x19.7"
C3 R11
 Lao Bone
 Lao Sand
 Lao Ash

Borde Samoa · Samoa edge



↗ 50x120cm 19.7"x48"
C3 R11
 Lao Bone
 Lao Sand
 Lao Ash

Rejilla de drenaje RJ25 · Drain grate RJ25



↗ 25x50cm 10"x19.7"

C3 R11 ·

Lao Bone

Lao Sand

Lao Ash

Desagüe · Drain: >13m³/hora

Goma para rejilla 9710 incluida
Grate rubber 9710 included

Rejilla de drenaje RJ25 FLEX · Drain grate RJ25 FLEX

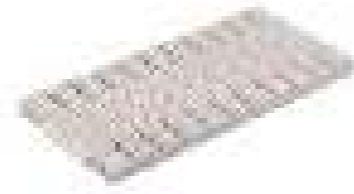

↗ 25x50cm 10"x19.7"

C3 R11 ·

Lao Bone

Lao Sand

Lao Ash

Desagüe · Drain: >30m³/hora

Goma para rejilla 9710 incluida
Grate rubber 9710 included

Goma para rejilla 9710 · Grate rubber 9710

Media caña exterior
Outer trim

↗ 4.5x50cm 1.8"x19.7"

C3 R11 · Ref. MDCA E000

Lao Bone

Lao Sand

Lao Ash

Escocia cantonera exterior
Scoth external corner

↗ 4.5x4.5cm 1.8"x1.8"

C3 R11 · Ref. MDCA EE00

Lao Bone

Lao Sand

Lao Ash

Esquina cantonera exterior
Outer angle corner

↗ 6.5x6.5cm 2.5"x2.5"

C3 R11 · Ref. MDCA AE00

Lao Bone

Lao Sand

Lao Ash

Media caña interior
Inner trim

↗ 5.5x50cm 2.1"x19.7"

C3 R11 · Ref. MDCA I000

Lao Bone

Lao Sand

Lao Ash

Escocia cantonera interior
Scoth inner corner

↗ 5.5x5.5cm 2.1"x2.1"

C3 R11 · Ref. MDCA EI00

Lao Bone

Lao Sand

Lao Ash

Esquina cantonera interior
Inner angle corner

↗ 6.5x6.5cm 2.5"x2.5"

C3 R11 · Ref. MDCA AI00

Lao Bone

Lao Sand

Lao Ash

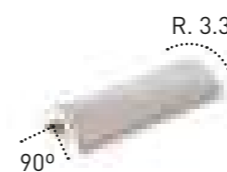
Cantonera transición exterior
External transition corner

↗ 4.5x16cm 1.8"x6.3"

C3 R11 · Ref. MDCA CE00

Lao Bone

Lao Sand

Lao Ash

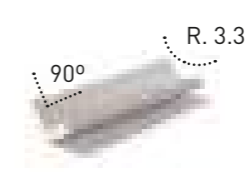
Cantonera transición interior
Inner transition corner

↗ 5.5x16cm 2.1"x6.3"

C3 R11 · Ref. MDCA CI00

Lao Bone

Lao Sand

Lao Ash

*Información detallada sobre las piezas de terminación en las páginas 252 y 253.

*Detailed information about trim pieces in pages 252 and 253.



COLECCIÓN
COLLECTION

CUPIRA







CUPIRA MULTI

CUPIRA HUESO



CUPIRA MARENGO



CUPIRA MULTI



FORMATOS · FORMATS

60x120cm 24"x48"
 37.5x75cm 15"x30"
 14.7x14.7cm 5.8"x5.8"

R11 · C1 · R9 · R
 C3 · C1 Cupira Hueso
 C3 Cupira Marengo

R11 · R
 C3 Cupira Hueso
 C3 Cupira Marengo
 C3 Cupira Multi

R11
 C3 Cupira Marengo
 C3 Cupira Multi

Rodapié
 Skirting board
 9x60cm 3.5"x24"
 Cupira Hueso
 Cupira Marengo
 Cupira Multi

Tabica
 Riser
 14.5x120cm 5.7"x48"
 Cupira Hueso
 Cupira Marengo
 Cupira Multi

EMBALAJE · PACKING

Formatos Formats	piezas / caja pieces / box	m ² / caja sqm / box	kg / caja kg / box	m ² / palet sqm / pallet	tamaño palet pallet size
60x120 ^R cm 24"x48"	2	1,4400	31,65	46,08	120x84x74cm
37.5x75 ^R cm 15"x30"	4	1,1250	23,50	61,87	120x80x89cm
14.7x14.7 ^R cm 5.8"x5.8"	44	0,9508	16,97	76,06	120x80x89cm
9x60cm 3.5"x24"	10	-	15,36	-	110x95x96cm
Rodapié · Skirting board					
14.5x120cm 5.7"x48"	6	-	22,20	-	125x110x90cm
Tabica · Riser					

COLORES JUNTA RECOMENDADOS · RECOMMENDED JOINT COLOURS

Cupira Hueso
 Mapei 100 White
 Kerakoll 01 Blanco
 Litokol White 1

Cupira Marengo
 Mapei 111 Silver Grey
 Kerakoll 04 Gris Hierro
 Litokol Silver 2

Cupira Multi
 Mapei 113 Cement Grey
 Kerakoll 05 Antracita
 Litokol Silver 3

Peldaño recto · Recto step



- ↗ 33x120cm 13"x48"
- C3 R11** **C1 R9**
- ☐ Cupira Hueso ☐ Cupira Hueso
- ☐ Cupira Marengo
- ☐ Cupira Multi

Peldaño recto tapa · Recto step corner



- ↗ 33x120cm 13"x48"
- C3 R11** **C1 R9**
- ☐ Cupira Hueso ☐ Cupira Hueso
- ☐ Cupira Marengo
- ☐ Cupira Multi

Borde Creta · Creta edge



- ↗ 33x50cm 13"x19.7"
- C3 R11**
- ☐ Cupira Hueso
- ☐ Cupira Marengo
- ☐ Cupira Multi

Rejilla de drenaje RJ25 · Drain grate RJ25



↗ 25x50cm 10"x19.7"

C3 R11 ·

Cupira Hueso

Cupira Marengo

Cupira Multi

Desagüe · Drain: >13m³/hora

Goma para rejilla 9710 incluida
Grate rubber 9710 included

Rejilla de drenaje RJ25 FLEX · Drain grate RJ25 FLEX



↗ 25x50cm 10"x19.7"

C3 R11 ·

Cupira Hueso

Cupira Marengo

Cupira Multi

Desagüe · Drain: >30m³/hora

Goma para rejilla 9710 incluida
Grate rubber 9710 included

Goma para rejilla 9710 · Grate rubber 9710

Media caña exterior
Outer trim

↗ 4.5x50cm 1.8"x19.7"

C3 R11 · Ref. MDCA E000

Cupira Hueso

Cupira Marengo

Cupira Multi

Escocia cantonera exterior
Scoth external corner

↗ 4.5x4.5cm 1.8"x1.8"

C3 R11 · Ref. MDCA EE00

Cupira Hueso

Cupira Marengo

Cupira Multi

Esquina cantonera exterior
Outer angle corner

↗ 6.5x6.5cm 2.5"x2.5"

C3 R11 · Ref. MDCA AE00

Cupira Hueso

Cupira Marengo

Cupira Multi

Media caña interior
Inner trim

↗ 5.5x50cm 2.1"x19.7"

C3 R11 · Ref. MDCA I000

Cupira Hueso

Cupira Marengo

Cupira Multi

Escocia cantonera interior
Scoth inner corner

↗ 5.5x5.5cm 2.1"x2.1"

C3 R11 · Ref. MDCA EI00

Cupira Hueso

Cupira Marengo

Cupira Multi

Esquina cantonera interior
Inner angle corner

↗ 6.5x6.5cm 2.5"x2.5"

C3 R11 · Ref. MDCA AI00

Cupira Hueso

Cupira Marengo

Cupira Multi

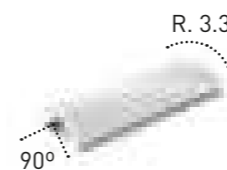
Cantonera transición exterior
External transition corner

↗ 4.5x16cm 1.8"x6.3"

C3 R11 · Ref. MDCA CE00

Cupira Hueso

Cupira Marengo

Cupira Multi

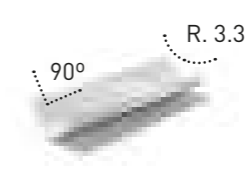
Cantonera transición interior
Inner transition corner

↗ 5.5x16cm 2.1"x6.3"

C3 R11 · Ref. MDCA CI00

Cupira Hueso

Cupira Marengo

Cupira Multi

*Información detallada sobre las piezas de terminación en las páginas 252 y 253.

*Detailed information about trim pieces in pages 252 and 253.



COLECCIÓN
COLLECTION

SALEM





SALEM CLAR



SALEM DUNE



120x120cm 48"x48"
 C3 R11 · C1 R9 · R
 Salem Clar
 Salem Dune

60x120cm 24"x48"
 C3 R11 · C1 R9 · R
 Salem Clar
 Salem Dune

90x90cm 36"x36"
 C3 R11 · C1 R9 · R
 Salem Clar
 Salem Dune

60x60cm 24"x24"
 C3 R11 · C1 R9 · R
 Salem Clar

90x90cm 36"x36"
 20MM 0.8"
 C3 R11 · R
 Salem Clar

Rodapié
 Skirting board
 9x60cm 3.5"x24"
 Salem Clar
 Salem Dune

Tabica
 Riser
 14.5x120cm 5.7"x48"
 Salem Clar
 Salem Dune

EMBALAJE · PACKING

Formatos Formats	piezas / caja pieces / box	m ² / caja sqm / box	kg / caja kg / box	m ² / palet sqm / pallet	tamaño palet pallet size
120x120 ^R cm 48"x48"	1	1,4400	31,00	57,6	135x121x58cm
60x120 ^R cm 24"x48"	2	1,4400	31,65	46,08	120x84x74cm
90x90 ^R cm 36"x36"	2	1,6200	32,50	48,60	106x95x74cm
90x90 ^R 2CM 36"x36"x0.8"	1	0,8100	39,00	21,87	105x95x84cm
60x60 ^R cm 24"x24"	4	1,4400	27,00	46,08	120x80x74cm
9x60cm 3.5"x24"	10	-	15,36	-	110x95x96cm
Rodapié · Skirting board					
14.5x120cm 5.7"x48"	6	-	22,20	-	125x110x90cm
Tabica · Riser					

COLORES JUNTA RECOMENDADOS · RECOMMENDED JOINT COLOURS

- Salem Clar
 Mapei 130 Jasmine
 Kerakoll 31 Beige Dakar
 Litokol Ivory 3
- Salem Dune
 Mapei 132 Beige 2000
 Kerakoll 08 Beige Bahama
 Litokol Beige 1

Peldaño recto · Recto step



↗ 33x120cm 13"x48"
C3 R11 · C1 R9
 Salem Clar
 Salem Dune

Peldaño recto tapa · Recto step corner



↗ 33x120cm 13"x48"
C3 R11 · C1 R9
 Salem Clar
 Salem Dune

Borde Creta · Creta edge



↗ 33x50cm 13"x19.7"
C3 R11
 Salem Clar
 Salem Dune

Borde Maui · Maui edge



↗ 33x50cm 13"x19.7"
C3 R11
 Salem Clar

Borde Samoa · Samoa edge



↗ 50x120cm 19.7"x48"
C3 R11
 Salem Clar

Rejilla de drenaje RJ20 · Drain grate RJ20



↗ 20x50cm 8"x19.7"



Salem Clar

Desagüe · Drain: >11m³/horaGoma para rejilla 9710 incluida
Grate rubber 9710 included

Rejilla de drenaje RJ20 FLEX · Drain grate RJ20 FLEX



↗ 20x50cm 8"x19.7"



Salem Clar

Desagüe · Drain: >30m³/horaGoma para rejilla 9710 incluida
Grate rubber 9710 included

Rejilla de drenaje RJ25 · Drain grate RJ25



↗ 25x50cm 10"x19.7"



Salem Clar

Salem Dune

Desagüe · Drain: >13m³/horaGoma para rejilla 9710 incluida
Grate rubber 9710 included

Rejilla de drenaje RJ25 FLEX · Drain grate RJ25 FLEX



↗ 25x50cm 10"x19.7"



Salem Clar

Salem Dune

Desagüe · Drain: >30m³/horaGoma para rejilla 9710 incluida
Grate rubber 9710 included

Rejilla de drenaje RJ25 INV · Drain grate RJ25 INV



↗ 25x50cm 10"x19.7"



Salem Clar

Desagüe · Drain: >8m³/horaGoma para rejilla 12719 incluida
Grate rubber 12719 included

Goma para rejilla 9710 · Grate rubber 9710



Goma para rejilla 12719 · Grate rubber 12719

Media caña exterior
Outer trim

↗ 4.5x50cm 1.8"x19.7"



Salem Clar

Salem Dune

Escocia cantonera exterior
Scotch external corner

↗ 4.5x4.5cm 1.8"x1.8"

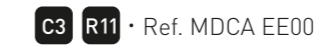

Salem Clar

Salem Dune

Esquina cantonera exterior
Outer angle corner

↗ 6.5x6.5cm 2.5"x2.5"

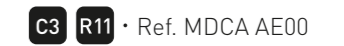

Salem Clar

Salem Dune

Media caña interior
Inner trim

↗ 5.5x50cm 2.1"x19.7"

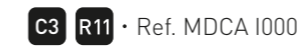

Salem Clar

Salem Dune

Escocia cantonera interior
Scotch inner corner

↗ 5.5x5.5cm 2.1"x2.1"

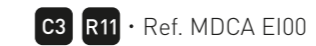

Salem Clar

Salem Dune

Esquina cantonera interior
Inner angle corner

↗ 6.5x6.5cm 2.5"x2.5"

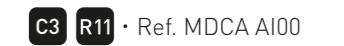

Salem Clar

Salem Dune

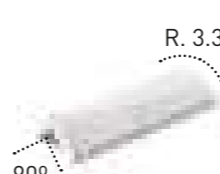
Cantonera transición exterior
External transition corner

↗ 4.5x16cm 1.8"x6.3"

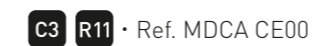

Salem Clar

Salem Dune

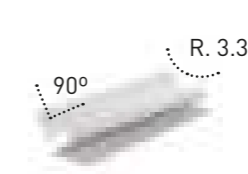
Cantonera transición interior
Inner transition corner

↗ 5.5x16cm 2.1"x6.3"

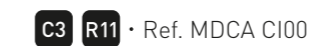

Salem Clar

Salem Dune

*Información detallada sobre las
piezas de terminación en las páginas
252 y 253.*Detailed information about trim
pieces in pages 252 and 253.



COLECCIÓN
COLLECTION

CORALINA





CORALINA AGUADA



CORALINA SAMANÁ



FORMATOS · FORMATS

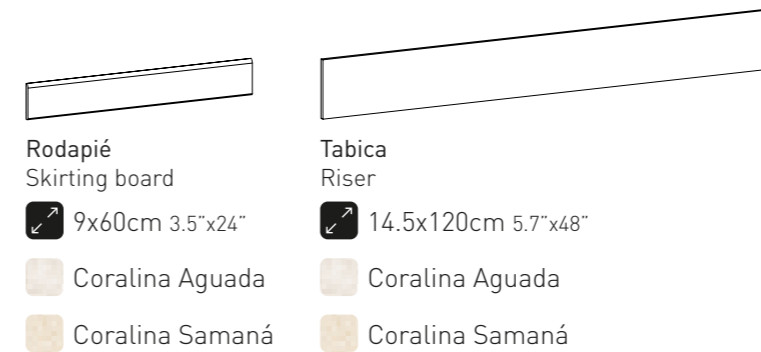
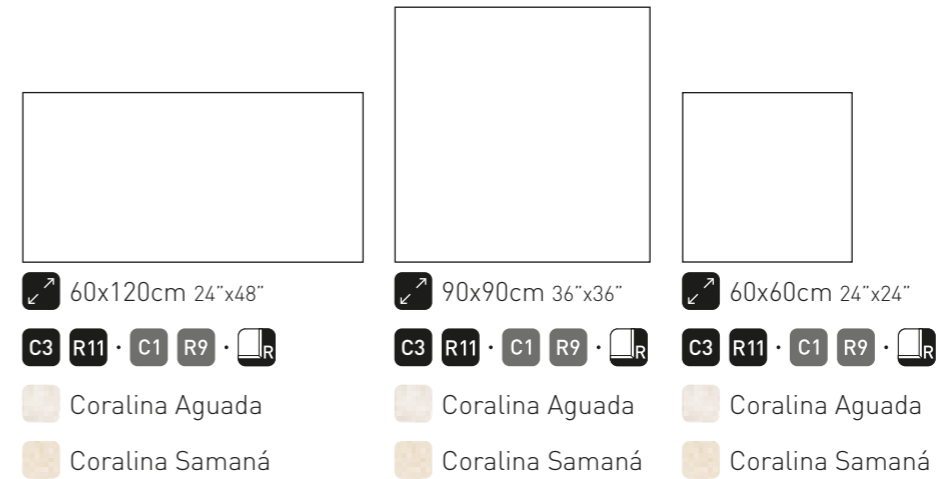

EMBALAJE · PACKING

Formatos Formats	piezas / caja pieces / box	m ² / caja sqm / box	kg / caja kg / box	m ² / palet sqm / pallet	tamaño palet pallet size
60x120 [®] cm 24"x48"	2	1,4400	31,65	46,08	120x84x74cm
90x90 [®] cm 36"x36"	2	1,6200	32,50	48,60	106x95x74cm
60x60 [®] cm 24"x24"	4	1,4400	27,00	46,08	120x80x74cm
9x60cm 3.5"x24"	10	-	15,36	-	110x95x96cm
Rodapié · Skirting board					
14.5x120cm 5.7"x48"	6	-	22,20	-	125x110x90cm
Tabica · Riser					

COLORES JUNTA RECOMENDADOS · RECOMMENDED JOINT COLOURS

 Coralina Aguada
 Mapei 130 Jasmine
 Kerakoll 31 Beige Dakar
 Litokol Ivory 2

 Coralina Samaná
 Mapei 132 Beige 2000
 Kerakoll 08 Beige Bahama
 Litokol Beige 1

Peldaño recto · Recto step



↗ 33x120cm 13"x48"
C3 R11 · C1 R9
 Coralina Aguada
 Coralina Samaná

Peldaño recto tapa · Recto step corner



↗ 33x120cm 13"x48"
C3 R11 · C1 R9
 Coralina Aguada
 Coralina Samaná

Borde Creta · Creta edge



↗ 33x50cm 13"x19.7"
C3 R11
 Coralina Aguada
 Coralina Samaná

Rejilla de drenaje RJ25 · Drain grate RJ25



↗ 25x50cm 10"x19.7"



Coralina Aguada

Coralina Samaná

Desagüe · Drain: >13m³/hora

Goma para rejilla 9710 incluida
Grate rubber 9710 included

Rejilla de drenaje RJ25 FLEX · Drain grate RJ25 FLEX

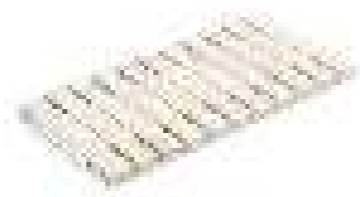

↗ 25x50cm 10"x19.7"



Coralina Aguada

Coralina Samaná

Desagüe · Drain: >30m³/hora

Goma para rejilla 9710 incluida
Grate rubber 9710 included

Goma para rejilla 9710 · Grate rubber 9710

Media caña exterior
Outer trim

↗ 4.5x50cm 1.8"x19.7"



Coralina Aguada

Coralina Samaná

Escocia cantonera exterior
Scotch external corner

↗ 4.5x4.5cm 1.8"x1.8"

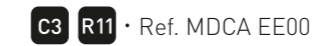

Coralina Aguada

Coralina Samaná

Esquina cantonera exterior
Outer angle corner

↗ 6.5x6.5cm 2.5"x2.5"

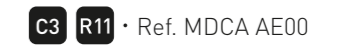

Coralina Aguada

Coralina Samaná

Media caña interior
Inner trim

↗ 5.5x50cm 2.1"x19.7"

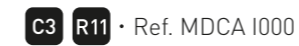

Coralina Aguada

Coralina Samaná

Escocia cantonera interior
Scotch inner corner

↗ 5.5x5.5cm 2.1"x2.1"

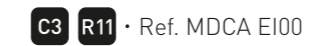

Coralina Aguada

Coralina Samaná

Esquina cantonera interior
Inner angle corner

↗ 6.5x6.5cm 2.5"x2.5"

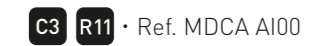

Coralina Aguada

Coralina Samaná

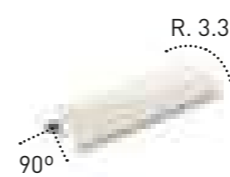
Cantonera transición exterior
External transition corner

↗ 4.5x16cm 1.8"x6.3"

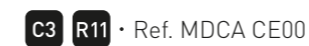

Coralina Aguada

Coralina Samaná

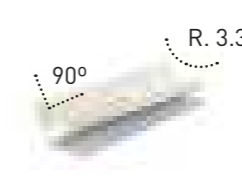
Cantonera transición interior
Inner transition corner

↗ 5.5x16cm 2.1"x6.3"

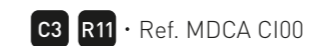

Coralina Aguada

Coralina Samaná

*Información detallada sobre las piezas de terminación en las páginas 252 y 253.

*Detailed information about trim pieces in pages 252 and 253.



COLECCIÓN
COLLECTION

CALACATTA





CALACATTA FRESH



FORMATOS · FORMATS



↙ ↘ 60x120cm 24"x48"

C3 R11 · C1 R9 · R

Calacatta Fresh



Rodapié
Skirting board

↙ ↘ 9x60cm 3.5"x24"

Calacatta Fresh



Tabica
Riser

↙ ↘ 14.5x120cm 5.7"x48"

Calacatta Fresh

EMBALAJE · PACKING

Formatos Formats	piezas / caja pieces / box	m ² / caja sqm / box	kg / caja kg / box	m ² / palet sqm / pallet	tamaño palet palet size
60x120 ^o cm 24"x48"	2	1,4400	31,65	46,08	120x84x74cm
9x60cm 3.5"x24"	10	-	15,36	-	110x95x96cm
Rodapié · Skirting board					
14.5x120cm 5.7"x48"	6	-	22,20	-	125x110x90cm
Tabica · Riser					

COLORES JUNTA RECOMENDADOS · RECOMMENDED JOINT COLOURS

Calacatta Fresh
Mapei 100 White
Kerakoll 01 Blanco
Litokol White 1

Peldaño recto · Recto step

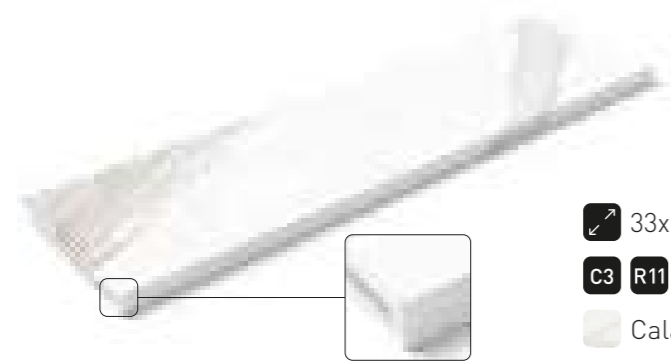

↗ 33x120cm 13"x48"
C3 R11 · C1 R9
 Calacatta Fresh

Peldaño recto tapa · Recto step corner



↗ 33x120cm 13"x48"
C3 R11 · C1 R9
 Calacatta Fresh

Borde Creta · Creta edge



↗ 33x50cm 13"x19.7"
C3 R11
 Calacatta Fresh

Rejilla de drenaje RJ25 · Drain grate RJ25

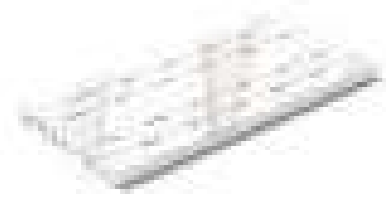

↗ 25x50cm 10"x19.7"

C3 R11 · 🌿 🌍

☑ Calacatta Fresh

Desagüe · Drain: >13m³/hora

Goma para rejilla 9710 incluida
Grate rubber 9710 included

Rejilla de drenaje RJ25 FLEX · Drain grate RJ25 FLEX



↗ 25x50cm 10"x19.7"

C3 R11 · 🌿 🌍

☑ Calacatta Fresh

Desagüe · Drain: >30m³/hora

Goma para rejilla 9710 incluida
Grate rubber 9710 included

Goma para rejilla 9710 · Grate rubber 9710

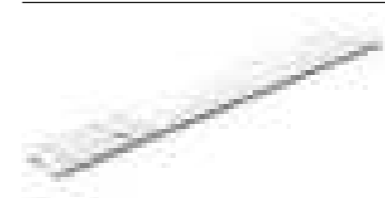
Media caña exterior
Outer trim

↗ 4.5x50cm 1.8"x19.7"

C3 R11 · Ref. MDCA E000

☑ Calacatta Fresh

Escocia cantonera exterior
Scotch external corner

↗ 4.5x4.5cm 1.8"x1.8"

C3 R11 · Ref. MDCA EE00

☑ Calacatta Fresh

Esquina cantonera exterior
Outer angle corner

↗ 6.5x6.5cm 2.5"x2.5"

C3 R11 · Ref. MDCA AE00

☑ Calacatta Fresh

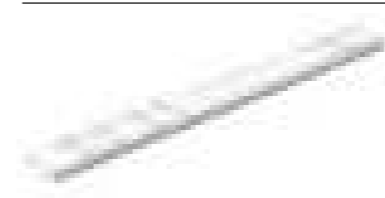
Media caña interior
Inner trim

↗ 5.5x50cm 2.1"x19.7"

C3 R11 · Ref. MDCA I000

☑ Calacatta Fresh

Escocia cantonera interior
Scotch inner corner

↗ 5.5x5.5cm 2.1"x2.1"

C3 R11 · Ref. MDCA EI00

☑ Calacatta Fresh

Esquina cantonera interior
Inner angle corner

↗ 6.5x6.5cm 2.5"x2.5"

C3 R11 · Ref. MDCA AI00

☑ Calacatta Fresh

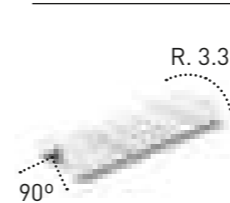
Cantonera transición exterior
External transition corner

↗ 4.5x16cm 1.8"x6.3"

C3 R11 · Ref. MDCA CE00

☑ Calacatta Fresh

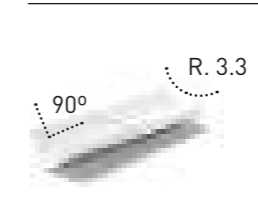
Cantonera transición interior
Inner transition corner

↗ 5.5x16cm 2.1"x6.3"

C3 R11 · Ref. MDCA CI00

☑ Calacatta Fresh

*Información detallada sobre las piezas de terminación en las páginas 252 y 253.

*Detailed information about trim pieces in pages 252 and 253.



COLECCIÓN
COLLECTION

ETERNA







ETERNA ALBA



ETERNA ARGENT



ETERNA CENDRA







FORMATOS · FORMATS



↗ 60x120cm 24"x48"



C3 R11 · C1 R9 · R

-  Eterna Alba
-  Eterna Argent
-  Eterna Cendra



↗ 37.5x75cm 15"x30"



C3 R11 · R

-  Eterna Alba
-  Eterna Argent
-  Eterna Cendra



Rodapié
Skirting board

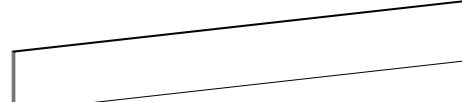

↗ 9x60cm 3.5"x24"

-  Eterna Alba
-  Eterna Argent
-  Eterna Cendra



Tabica
Riser

↗ 14.5x120cm 5.7"x48"

-  Eterna Alba
-  Eterna Argent
-  Eterna Cendra

EMBALAJE · PACKING

Formatos Formats	piezas / caja pieces / box	m ² / caja sqm / box	kg / caja kg / box	m ² / palet sqm / pallet	tamaño palet palet size
60x120 ^R cm 24"x48"	2	1,4400	31,65	46,08	120x84x74cm
37.5x75 ^R cm 15"x30"	4	1,1250	23,50	61,87	120x80x89cm
9x60cm 3.5"x24"	10	-	15,36	-	110x95x96cm
Rodapié · Skirting board					
14.5x120cm 5.7"x48"	6	-	22,20	-	125x110x90cm
Tabica · Riser					

COLORES JUNTA RECOMENDADOS · RECOMMENDED JOINT COLOURS

 Eterna Alba
Mapei 100 White
Kerakoll 01 Blanco
Litokol White 1

 Eterna Argent
Mapei 113 Cement Grey
Kerakoll 04 Gris Hierro
Litokol Silver 3

 Eterna Cendra
Mapei 114 Anthracite
Kerakoll 05 Antracita
Litokol Black 1

Peldaño recto · Recto step



↗ 33x120cm 13"x48"

C3 R11 · C1 R9

Eterna Alba

Eterna Argent

Eterna Cendra

Peldaño recto tapa · Recto step corner



↗ 33x120cm 13"x48"

C3 R11 · C1 R9

Eterna Alba

Eterna Argent

Eterna Cendra



COLECCIÓN
COLLECTION

STROMBOLI







STROMBOLI LIGHT

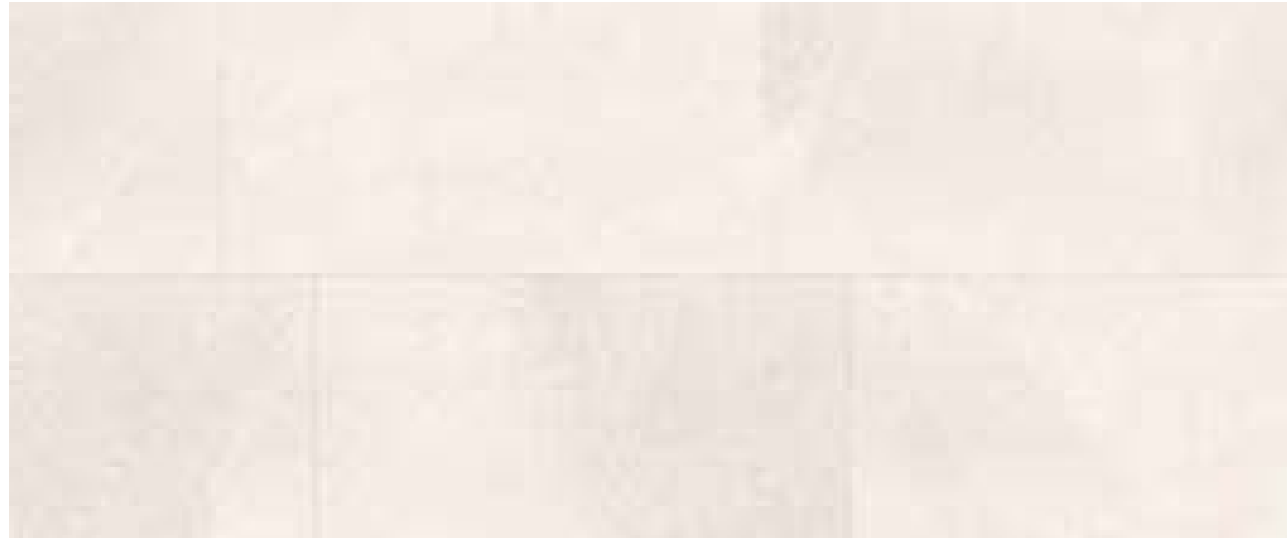

STROMBOLI CREAM



STROMBOLI SILVER

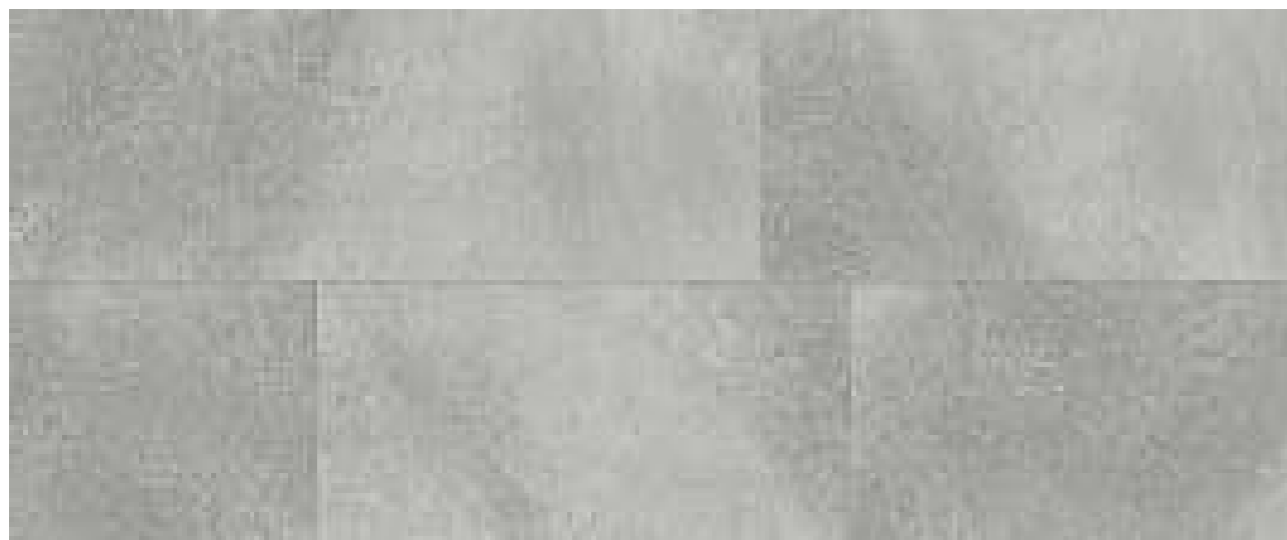

↖ ↗ 60x120cm 24"x48"	↖ ↗ 75x75cm 30"x30"	↖ ↗ 60x60cm 24"x24"	↖ ↗ 37.5x75cm 15"x30"
C3 R11 · C1 R9 · R	C3 R11 · C1 R9 · R	C3 R11 · R	C3 R11 · R
Stromboli Light	Stromboli Light	Stromboli Light	Stromboli Light
Stromboli Cream	Stromboli Cream	Stromboli Cream	Stromboli Cream
Stromboli Silver	Stromboli Silver	Stromboli Silver	Stromboli Silver

↖ ↗ 60x120cm 24"x48"	↖ ↗ 9x60cm 3.5"x24"	↖ ↗ 14.5x120cm 5.7"x48"
20MM 0.8"		
C3 R11 · R		
Stromboli Light	Stromboli Light	Stromboli Light
	Stromboli Cream	Stromboli Cream
	Stromboli Silver	Stromboli Silver

EMBALAJE · PACKING

Formatos Formats	piezas / caja pieces / box	m ² / caja sqm / box	kg / caja kg / box	m ² / palet sqm / pallet	tamaño palet pallet size
60x120 ^R cm 24"x48"	2	1,4400	31,65	46,08	120x84x74cm
60x120 ^R 2CM 24"x48"x0.8"	1	0,7200	34,37	19,44	120x84x74cm
75x75 ^R cm 30"x30"	2	1,1250	23,50	54,00	120x80x90cm
60x60 ^R cm 24"x24"	4	1,4400	27,00	46,08	120x80x74cm
37.5x75 ^R cm 15"x30"	4	1,1250	23,50	61,87	120x80x89cm
9x60cm 3.5"x24"	10	-	15,36	-	110x95x96cm
Rodapié · Skirting board					
14.5x120cm 5.7"x48"	6	-	22,20	-	125x110x90cm
Tabica · Riser					

COLORES JUNTA RECOMENDADOS · RECOMMENDED JOINT COLOURS

Stromboli Light Mapei 100 White Kerakoll 01 Blanco Litokol White 1	Stromboli Cream Mapei 130 Jasmine Kerakoll 31 Beige Dakar Litokol Ivory 2	Stromboli Silver Mapei 112 Medium Grey Kerakoll 04 Gris Hierro Litokol Silver 2
---	--	--

Peldaño recto · Recto step



- ↗ 33x120cm 13"x48"
C3 R11 · C1 R9
 Stromboli Light
 Stromboli Cream
 Stromboli Silver

Peldaño recto tapa · Recto step corner



- ↗ 33x120cm 13"x48"
C3 R11 · C1 R9
 Stromboli Light
 Stromboli Cream
 Stromboli Silver

Peldaño completo · Full step



- ↗ 33x120cm 13"x48"
C3 R11
 Stromboli Light
 Stromboli Cream
 Stromboli Silver

Borde Creta · Creta edge



- ↗ 33x50cm 13"x19.7"
C3 R11
 Stromboli Light
 Stromboli Cream
 Stromboli Silver

Borde Maui · Maui edge



- ↗ 33x50cm 13"x19.7"
C3 R11
 Stromboli Light
 Stromboli Cream
 Stromboli Silver

Borde Bora · Bora edge



- ↗ 20x50cm 8"x19.7"
C3 R11
 Stromboli Light
 Stromboli Cream
 Stromboli Silver

Borde Aruba · Aruba edge



- ↗ 25x50cm 10"x19.7"
C3 R11
 Stromboli Light
 Stromboli Cream
 Stromboli Silver

Borde Samoa · Samoa edge



- ↗ 50x120cm 19.7"x48"
C3 R11
 Stromboli Light
 Stromboli Cream

Rejilla de drenaje RJ20 · Drain grate RJ20



↗ 20x50cm 8"x19.7"



Stromboli Light

Stromboli Cream

Stromboli Silver

Desagüe · Drain: >11m³/hora

Goma para rejilla 9710 incluida
Grate rubber 9710 included

Rejilla de drenaje RJ20 FLEX · Drain grate RJ20 FLEX



↗ 20x50cm 8"x19.7"



Stromboli Light

Stromboli Cream

Stromboli Silver

Desagüe · Drain: >30m³/hora

Goma para rejilla 9710 incluida
Grate rubber 9710 included

Rejilla de drenaje RJ25 · Drain grate RJ25



↗ 25x50cm 10"x19.7"



Stromboli Light

Stromboli Cream

Stromboli Silver

Desagüe · Drain: >13m³/hora

Goma para rejilla 9710 incluida
Grate rubber 9710 included

Rejilla de drenaje RJ25 FLEX · Drain grate RJ25 FLEX



↗ 25x50cm 10"x19.7"



Stromboli Light

Stromboli Cream

Stromboli Silver

Desagüe · Drain: >30m³/hora

Goma para rejilla 9710 incluida
Grate rubber 9710 included

Rejilla de drenaje RJ25 INV · Drain grate RJ25 INV



↗ 25x50cm 10"x19.7"



Stromboli Light

Stromboli Cream

Stromboli Silver

Desagüe · Drain: >8m³/hora

Goma para rejilla 12719 incluida
Grate rubber 12719 included

Goma para rejilla 9710 · Grate rubber 9710



Goma para rejilla 12719 · Grate rubber 12719

Media caña exterior
Outer trim

↗ 4.5x50cm 1.8"x19.7"

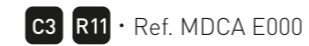

Stromboli Light

Stromboli Cream

Stromboli Silver

Escocia cantonera exterior
Scotch external corner

↗ 4.5x4.5cm 1.8"x1.8"

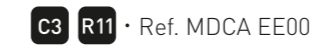

Stromboli Light

Stromboli Cream

Stromboli Silver

Esquina cantonera exterior
Outer angle corner

↗ 6.5x6.5cm 2.5"x2.5"



Stromboli Light

Stromboli Cream

Stromboli Silver

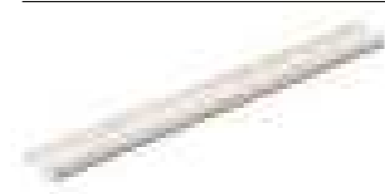
Media caña interior
Inner trim

↗ 5.5x50cm 2.1"x19.7"

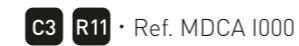

Stromboli Light

Stromboli Cream

Stromboli Silver

Escocia cantonera interior
Scotch inner corner

↗ 5.5x5.5cm 2.1"x2.1"

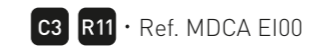

Stromboli Light

Stromboli Cream

Stromboli Silver

Esquina cantonera interior
Inner angle corner

↗ 6.5x6.5cm 2.5"x2.5"



Stromboli Light

Stromboli Cream

Stromboli Silver

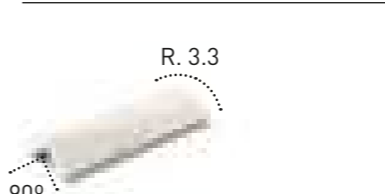
Cantonera transición exterior
External transition corner

↗ 4.5x16cm 1.8"x6.3"

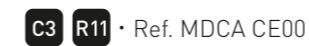

Stromboli Light

Stromboli Cream

Stromboli Silver

Cantonera transición interior
Inner transition corner

↗ 5.5x16cm 2.1"x6.3"

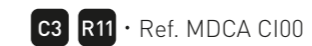

Stromboli Light

Stromboli Cream

Stromboli Silver

*Información detallada sobre las piezas de terminación en las páginas 252 y 253.

*Detailed information about trim pieces in pages 252 and 253.



COLECCIÓN
COLLECTION

CEMENTS







CEMENTS SNOW

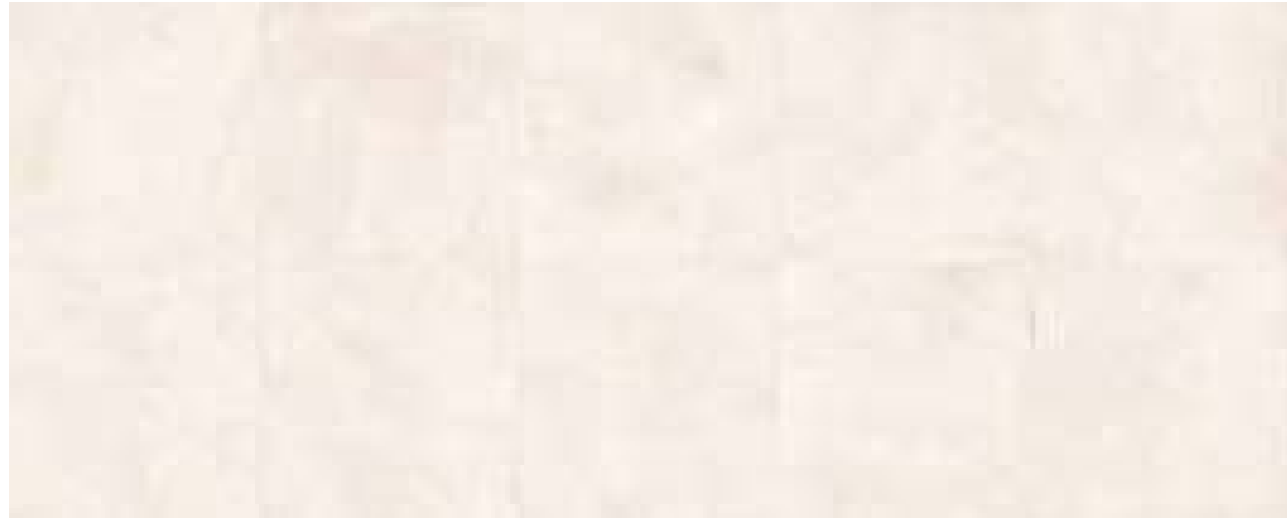

CEMENTS WARM



CEMENTS SMOKE



60x120cm 24"x48"
 C3 R11 · C1 R9 · UR
 Cements Snow

75x75cm 30"x30"
 C3 R11 · C1 R9 · UR
 Cements Snow
 Cements Warm
 Cements Smoke

37.5x75cm 15"x30"
 C3 R11 · UR
 Cements Snow
 Cements Warm
 Cements Smoke

Rodapié
 Skirting board
 9x60cm 3.5"x24"
 Cements Snow
 Cements Warm
 Cements Smoke

Tabica
 Riser
 14.5x120cm 5.7"x48"
 Cements Snow
 Cements Warm
 Cements Smoke

EMBALAJE · PACKING

Formatos Formats	piezas / caja pieces / box	m ² / caja sqm / box	kg / caja kg / box	m ² / palet sqm / pallet	tamaño palet palet size
60x120 ^R cm 24"x48"	2	1,4400	31,65	46,08	120x84x74cm
75x75 ^R cm 30"x30"	2	1,1250	23,50	54,00	120x80x90cm
37.5x75 ^R cm 15"x30"	4	1,1250	23,50	61,87	120x80x89cm
9x60cm 3.5"x24"	10	-	15,36	-	110x95x96cm
Rodapié · Skirting board					
14.5x120cm 5.7"x48"	6	-	22,20	-	125x110x90cm
Tabica · Riser					

COLORES JUNTA RECOMENDADOS · RECOMMENDED JOINT COLOURS

Cements Snow
 Mapei 100 White
 Kerakoll 01 Blanco
 Litokol White 1

Cements Warm
 Mapei 142 Brown
 Kerakoll 09 Caramelo
 Litokol Beige 3

Cements Smoke
 Mapei 112 Medium Grey
 Kerakoll 04 Gris Hierro
 Litokol Silver 2

Peldaño recto · Recto step



- ↗ 33x120cm 13"x48"
- C3** **R11** · **C1** **R9**
- Cements Snow
 - Cements Warm
 - Cements Smoke

Peldaño recto tapa · Recto step corner



- ↗ 33x120cm 13"x48"
- C3** **R11** · **C1** **R9**
- Cements Snow
 - Cements Warm
 - Cements Smoke

Borde Creta · Creta edge



- ↗ 33x50cm 13"x19.7"
- C3** **R11**
- Cements Snow
 - Cements Warm
 - Cements Smoke

Rejilla de drenaje RJ25 · Drain grate RJ25



↗ 25x50cm 10"x19.7"

C3 R11 ·

Cements Snow

Cements Warm

Cements Smoke

Desagüe · Drain: >13m³/hora

Goma para rejilla 9710 incluida
Grate rubber 9710 included

Rejilla de drenaje RJ25 FLEX · Drain grate RJ25 FLEX

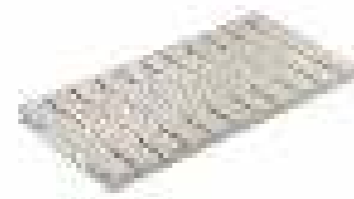

↗ 25x50cm 10"x19.7"

C3 R11 ·

Cements Snow

Cements Warm

Cements Smoke

Desagüe · Drain: >30m³/hora

Goma para rejilla 9710 incluida
Grate rubber 9710 included

Goma para rejilla 9710 · Grate rubber 9710



Media caña exterior
Outer trim



↗ 4.5x50cm 1.8"x19.7"

C3 R11 · Ref. MDCA E000

Cements Snow

Cements Warm

Cements Smoke

Escocia cantonera exterior
Scoth external corner



↗ 4.5x4.5cm 1.8"x1.8"

C3 R11 · Ref. MDCA EE00

Cements Snow

Cements Warm

Cements Smoke

Esquina cantonera exterior
Outer angle corner



↗ 6.5x6.5cm 2.5"x2.5"

C3 R11 · Ref. MDCA AE00

Cements Snow

Cements Warm

Cements Smoke

Media caña interior
Inner trim



↗ 5.5x50cm 2.1"x19.7"

C3 R11 · Ref. MDCA I000

Cements Snow

Cements Warm

Cements Smoke

Escocia cantonera interior
Scoth inner corner



↗ 5.5x5.5cm 2.1"x2.1"

C3 R11 · Ref. MDCA EI00

Cements Snow

Cements Warm

Cements Smoke

Esquina cantonera interior
Inner angle corner



↗ 6.5x6.5cm 2.5"x2.5"

C3 R11 · Ref. MDCA AI00

Cements Snow

Cements Warm

Cements Smoke

Cantonera transición exterior
External transition corner

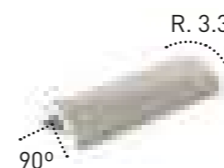

↗ 4.5x16cm 1.8"x6.3"

C3 R11 · Ref. MDCA CE00

Cements Snow

Cements Warm

Cements Smoke

Cantonera transición interior
Inner transition corner

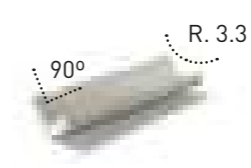

↗ 5.5x16cm 2.1"x6.3"

C3 R11 · Ref. MDCA CI00

Cements Snow

Cements Warm

Cements Smoke

*Información detallada sobre las piezas de terminación en las páginas 252 y 253.

*Detailed information about trim pieces in pages 252 and 253.



COLECCIÓN
COLLECTION

AMAZONIA





AMAZONIA MIEL



AMAZONIA CANELA



FORMATOS · FORMATS



↗ 30x120cm 12"x48"

C3 R11 · C1 R9 · R

Amazonia Miel

Amazonia Canela

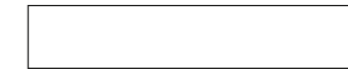

↗ 20x120cm 8"x48"

C3 R11 · C1 R9 · R

Amazonia Miel

Amazonia Canela



Rodapié
Skirting board

↗ 9x60cm 3.5"x24"

Amazonia Miel

Amazonia Canela

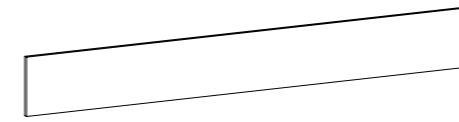

Tabica
Riser

↗ 14.5x120cm 5.7"x48"

Amazonia Miel

Amazonia Canela

EMBALAJE · PACKING

Formatos Formats	piezas / caja pieces / box	m ² / caja sqm / box	kg / caja kg / box	m ² / palet sqm / pallet	tamaño palet palet size
30x120 ⁶ cm 12"x48"	4	1,4400	33,37	57,60	120x80x74cm
20x120 ⁶ cm 8"x48"	7	1,6800	34,54	73,92	120x80x83cm
9x60cm 3.5"x24"	10	-	15,36	-	110x95x96cm
Rodapié · Skirting board					
14.5x120cm 5.7"x48"	6	-	22,20	-	125x110x90cm
Tabica · Riser					

COLORES JUNTA RECOMENDADOS · RECOMMENDED JOINT COLOURS

Amazonia Miel

Mapei 141 Caramel
Kerakoll 09 Caramelo
Litokol Beige 4

Amazonia Canela

Mapei 142 Brown
Kerakoll 11 Marrón
Litokol Brown 1

Peldaño recto · Recto step



↗ 33x120cm 13"x48"
C3 R11 · C1 R9
 Amazonia Miel
 Amazonia Canela

Peldaño recto tapa · Recto step corner



↗ 33x120cm 13"x48"
C3 R11 · C1 R9
 Amazonia Miel
 Amazonia Canela

Borde Creta · Creta edge



↗ 33x50cm 13"x19.7"
C3 R11
 Amazonia Miel
 Amazonia Canela

Rejilla de drenaje RJ25 · Drain grate RJ25



↗ 25x50cm 10"x19.7"

C3 R11 · 🌿 🌍

Amazonia Miel

Amazonia Canela

Desagüe · Drain: >13m³/hora

Goma para rejilla 9710 incluida
Grate rubber 9710 included

Rejilla de drenaje RJ25 FLEX · Drain grate RJ25 FLEX



↗ 25x50cm 10"x19.7"

C3 R11 · 🌿 🌍

Amazonia Miel

Amazonia Canela

Desagüe · Drain: >30m³/hora

Goma para rejilla 9710 incluida
Grate rubber 9710 included

Goma para rejilla 9710 · Grate rubber 9710

Media caña exterior
Outer trim

↗ 4.5x50cm 1.8"x19.7"

C3 R11 · Ref. MDCA E000

Amazonia Miel

Amazonia Canela

Escocia cantonera exterior
Scotch external corner

↗ 4.5x4.5cm 1.8"x1.8"

C3 R11 · Ref. MDCA EE00

Amazonia Miel

Amazonia Canela

Esquina cantonera exterior
Outer angle corner

↗ 6.5x6.5cm 2.5"x2.5"

C3 R11 · Ref. MDCA AE00

Amazonia Miel

Amazonia Canela

Media caña interior
Inner trim

↗ 5.5x50cm 2.1"x19.7"

C3 R11 · Ref. MDCA I000

Amazonia Miel

Amazonia Canela

Escocia cantonera interior
Scotch inner corner

↗ 5.5x5.5cm 2.1"x2.1"

C3 R11 · Ref. MDCA EI00

Amazonia Miel

Amazonia Canela

Esquina cantonera interior
Inner angle corner

↗ 6.5x6.5cm 2.5"x2.5"

C3 R11 · Ref. MDCA AI00

Amazonia Miel

Amazonia Canela

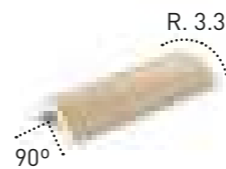
Cantonera transición exterior
External transition corner

↗ 4.5x16cm 1.8"x6.3"

C3 R11 · Ref. MDCA CE00

Amazonia Miel

Amazonia Canela

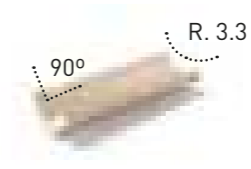
Cantonera transición interior
Inner transition corner

↗ 5.5x16cm 2.1"x6.3"

C3 R11 · Ref. MDCA CI00

Amazonia Miel

Amazonia Canela

*Información detallada sobre las piezas de terminación en las páginas 252 y 253.

*Detailed information about trim pieces in pages 252 and 253.



COLECCIÓN
COLLECTION

WOODS





WOODS ARCTIC



WOODS NORDIC



WOODS OLIVO



FORMATOS · FORMATS



↗ 20x120cm 8"x48"

C3 R11 · C1 R9 · R

Woods Arctic

Woods Nordic

Woods Olivo



Rodapié
Skirting board

↗ 9x60cm 3.5"x24"

Woods Arctic

Woods Nordic

Woods Olivo



Tabica
Riser

↗ 14.5x120cm 5.7"x48"

Woods Arctic

Woods Nordic

Woods Olivo

EMBALAJE · PACKING

Formatos Formats	piezas / caja pieces / box	m ² / caja sqm / box	kg / caja kg / box	m ² / palet sqm / pallet	tamaño palet palet size
20x120cm 8"x48"	7	1,6800	34,54	73,92	120x80x83cm
9x60cm 3.5"x24"	10	-	15,36	-	110x95x96cm
Rodapié · Skirting board					
14.5x120cm 5.7"x48"	6	-	22,20	-	125x110x90cm
Tabica · Riser					

COLORES JUNTA RECOMENDADOS · RECOMMENDED JOINT COLOURS

Woods Arctic
Mapei 100 White
Kerakoll 01 Blanco
Litokol White 1

Woods Nordic
Mapei 141 Caramel
Kerakoll 09 Caramelo
Litokol Beige 3

Woods Olivo
Mapei 112 Medium Grey
Kerakoll 04 Gris Hierro
Litokol Silver 2

Peldaño recto · Recto step



↗ 33x120cm 13"x48"

C3 R11 · C1 R9

Woods Arctic

Woods Nordic

Woods Olivo

Peldaño recto tapa · Recto step corner



↗ 33x120cm 13"x48"

C3 R11 · C1 R9

Woods Arctic

Woods Nordic

Woods Olivo

Borde Creta · Creta edge



↗ 33x50cm 13"x19.7"

C3 R11

Woods Arctic

Woods Nordic

Woods Olivo

Rejilla de drenaje RJ25 · Drain grate RJ25



↗ 25x50cm 10"x19.7"



Woods Arctic

Woods Nordic

Woods Olivo

Desagüe · Drain: >13m³/hora

Goma para rejilla 9710 incluida
Grate rubber 9710 included

Rejilla de drenaje RJ25 FLEX · Drain grate RJ25 FLEX



↗ 25x50cm 10"x19.7"



Woods Arctic

Woods Nordic

Woods Olivo

Desagüe · Drain: >30m³/hora

Goma para rejilla 9710 incluida
Grate rubber 9710 included

Goma para rejilla 9710 · Grate rubber 9710

Media caña exterior
Outer trim

↗ 4.5x50cm 1.8"x19.7"

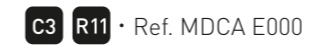

Woods Arctic

Woods Nordic

Woods Olivo

Escocia cantonera exterior
Scoth external corner

↗ 4.5x4.5cm 1.8"x1.8"

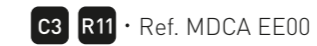

Woods Arctic

Woods Nordic

Woods Olivo

Esquina cantonera exterior
Outer angle corner

↗ 6.5x6.5cm 2.5"x2.5"

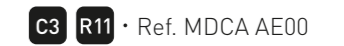

Woods Arctic

Woods Nordic

Woods Olivo

Media caña interior
Inner trim

↗ 5.5x50cm 2.1"x19.7"

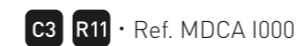

Woods Arctic

Woods Nordic

Woods Olivo

Escocia cantonera interior
Scoth inner corner

↗ 5.5x5.5cm 2.1"x2.1"

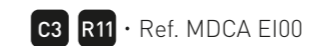

Woods Arctic

Woods Nordic

Woods Olivo

Esquina cantonera interior
Inner angle corner

↗ 6.5x6.5cm 2.5"x2.5"

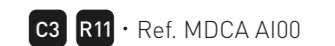

Woods Arctic

Woods Nordic

Woods Olivo

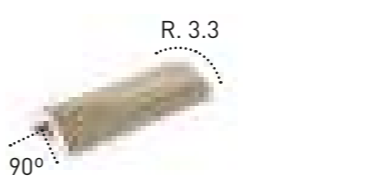
Cantonera transición exterior
External transition corner

↗ 4.5x16cm 1.8"x6.3"

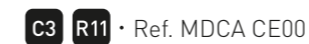

Woods Arctic

Woods Nordic

Woods Olivo

Cantonera transición interior
Inner transition corner

↗ 5.5x16cm 2.1"x6.3"

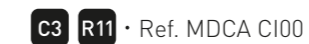

Woods Arctic

Woods Nordic

Woods Olivo

*Información detallada sobre las piezas de terminación en las páginas 252 y 253.

*Detailed information about trim pieces in pages 252 and 253.



COLECCIÓN
COLLECTION

TROPIC





TROPIC TURQUETA



C3 R11

C1 R9

TROPIC AGUAMARINA

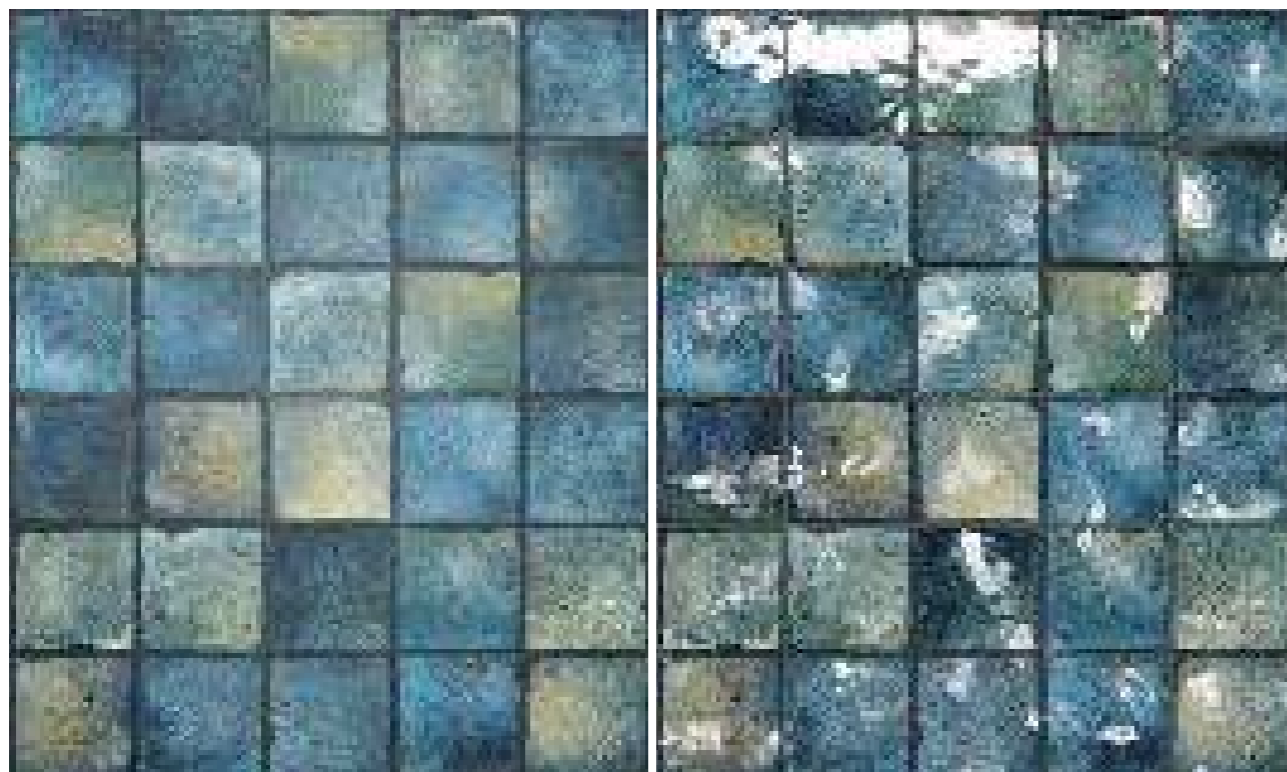

C3 R11

C1 R9

FORMATOS · FORMATS



↗ 14.7x14.7cm 5.8"x5.8"

C3 R11 · C1 R9

Tropic Turqueta

Tropic Aguamarina

EMBALAJE · PACKING

Formatos Formats	piezas / caja pieces / box	m ² / caja sqm / box	kg / caja kg / box	m ² / palet sqm / pallet	tamaño palet palet size
14.7x14.7"cm 5.8"x5.8" OUT	44	0,9508	16,97	76,06	120x80x89cm
14.7x14.7"cm 5.8"x5.8" IN	42	0,9076	16,20	72,60	120x80x89cm

COLORES JUNTA RECOMENDADOS · RECOMMENDED JOINT COLOURS

Tropic Turqueta
Mapei 114 Anthracite
Kerakoll 06 Negro
Litokol Black 1

Tropic Aguamarina
Mapei 114 Anthracite
Kerakoll 06 Negro
Litokol Black 1

Media caña exterior
Outer trim



↗ 4.5x50cm 1.8"x19.7"
C3 R11 · C1 R9 · Ref. MDCA E000
 Tropic Turqueta
 Tropic Aguamarina

Escocia cantonera exterior
Scoth external corner



↗ 4.5x4.5cm 1.8"x1.8"
C3 R11 · C1 R9 · Ref. MDCA EE00
 Tropic Turqueta
 Tropic Aguamarina

Esquina cantonera exterior
Outer angle corner



↗ 6.5x6.5cm 2.5"x2.5"
C3 R11 · C1 R9 · Ref. MDCA AE00
 Tropic Turqueta
 Tropic Aguamarina

Media caña interior
Inner trim



↗ 5.5x50cm 2.1"x19.7"
C3 R11 · C1 R9 · Ref. MDCA I000
 Tropic Turqueta
 Tropic Aguamarina

Escocia cantonera interior
Scoth inner corner



↗ 5.5x5.5cm 2.1"x2.1"
C3 R11 · C1 R9 · Ref. MDCA EI00
 Tropic Turqueta
 Tropic Aguamarina

Esquina cantonera interior
Inner angle corner



↗ 6.5x6.5cm 2.5"x2.5"
C3 R11 · C1 R9 · Ref. MDCA AI00
 Tropic Turqueta
 Tropic Aguamarina

Cantonera transición exterior
External transition corner

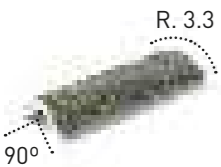

↗ 4.5x16cm 1.8"x6.3"
C3 R11 · C1 R9 · Ref. MDCA CE00
 Tropic Turqueta
 Tropic Aguamarina

Cantonera transición interior
Inner transition corner

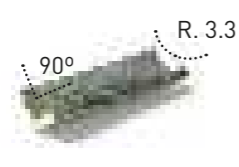

↗ 5.5x16cm 2.1"x6.3"
C3 R11 · C1 R9 · Ref. MDCA CI00
 Tropic Turqueta
 Tropic Aguamarina

*Información detallada sobre las
piezas de terminación en las páginas
252 y 253.
 *Detailed information about trim
pieces in pages 252 and 253.



COLECCIÓN
COLLECTION

BALI



BALI ZATU



FORMATOS · FORMATS



↗ 30x60cm 12"x24"



Bali Zatu



↗ 14.7x14.7cm 5.8"x5.8"



Bali Zatu

EMBALAJE · PACKING

Formatos Formats	piezas / caja pieces / box	m ² / caja sqm / box	kg / caja kg / box	m ² / palet sqm / pallet	tamaño palet palet size
30x60 ^R cm 12"x24"	8	1,4400	27,00	57,60	120x80x74cm
14.7x14.7 ^R cm 5.8"x5.8" OUT	44	0,9508	16,97	76,06	120x80x89cm

COLORES JUNTA RECOMENDADOS · RECOMMENDED JOINT COLOURS



Bali Zatu

Mapei 180 Mint
Kerakoll 29 Verde Asturias
Litokol Verde Capri 810

Media caña exterior
Outer trim



↗ 4.5x50cm 1.8"x19.7"

C3 **R11** · Ref. MDCA E000

 Bali Zatu

Escocia cantonera exterior
Scotch external corner



↗ 4.5x4.5cm 1.8"x1.8"

C3 **R11** · Ref. MDCA EE00

 Bali Zatu

Esquina cantonera exterior
Outer angle corner



↗ 6.5x6.5cm 2.5"x2.5"

C3 **R11** · Ref. MDCA AE00

 Bali Zatu

Media caña interior
Inner trim



↗ 5.5x50cm 2.1"x19.7"

C3 **R11** · Ref. MDCA I000

 Bali Zatu

Escocia cantonera interior
Scotch inner corner



↗ 5.5x5.5cm 2.1"x2.1"

C3 **R11** · Ref. MDCA EI00

 Bali Zatu

Esquina cantonera interior
Inner angle corner



↗ 6.5x6.5cm 2.5"x2.5"

C3 **R11** · Ref. MDCA AI00

 Bali Zatu

Cantonera transición exterior
External transition corner

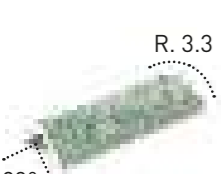

↗ 4.5x16cm 1.8"x6.3"

C3 **R11** · Ref. MDCA CE00

 Bali Zatu

Cantonera transición interior
Inner transition corner

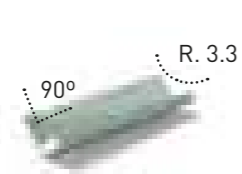

↗ 5.5x16cm 2.1"x6.3"

C3 **R11** · Ref. MDCA CI00

 Bali Zatu

*Información detallada sobre las piezas de terminación en las páginas 252 y 253.

*Detailed information about trim pieces in pages 252 and 253.

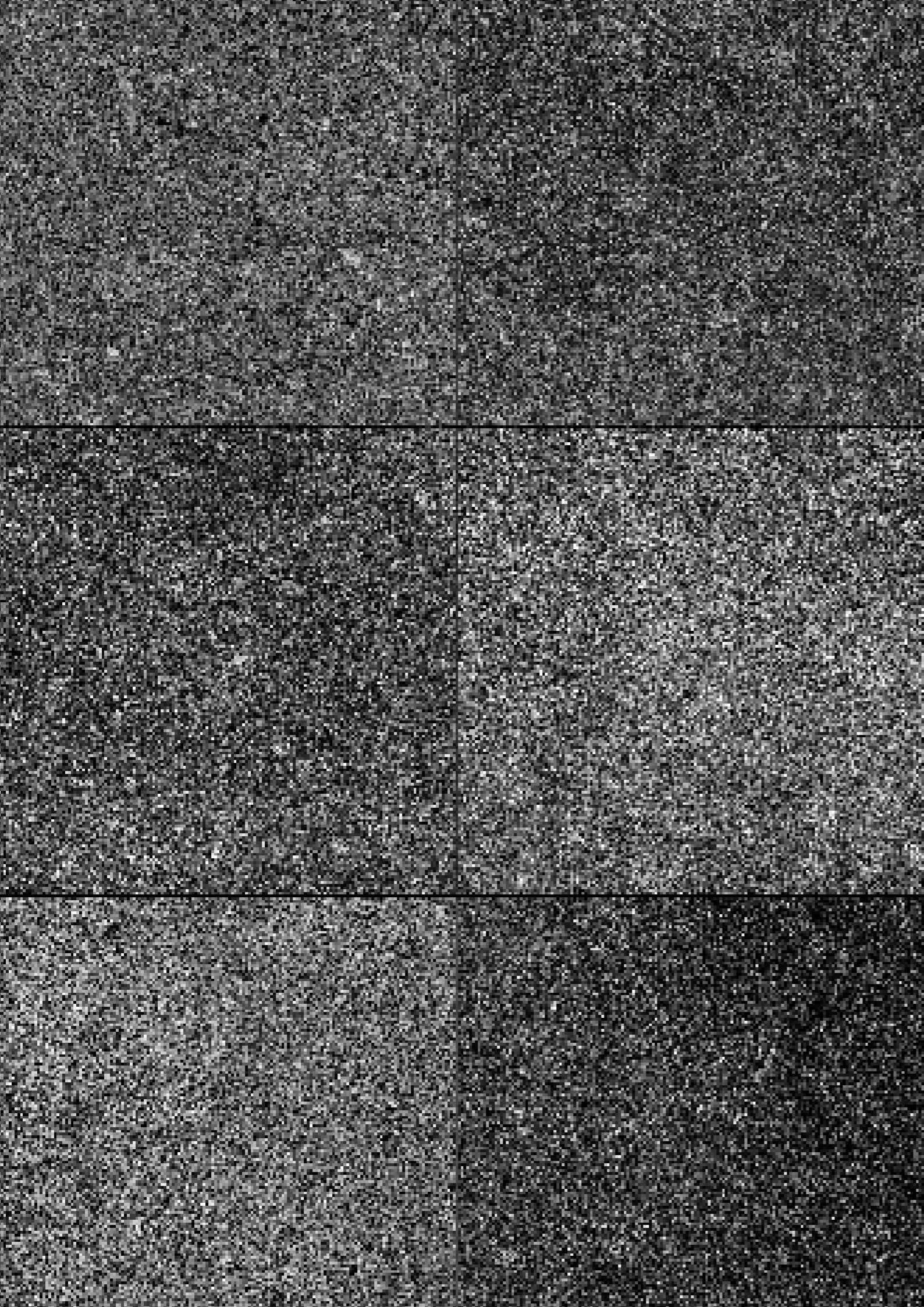

COLECCIÓN
COLLECTION

VOLCANIC



VOLCANIC LAVA

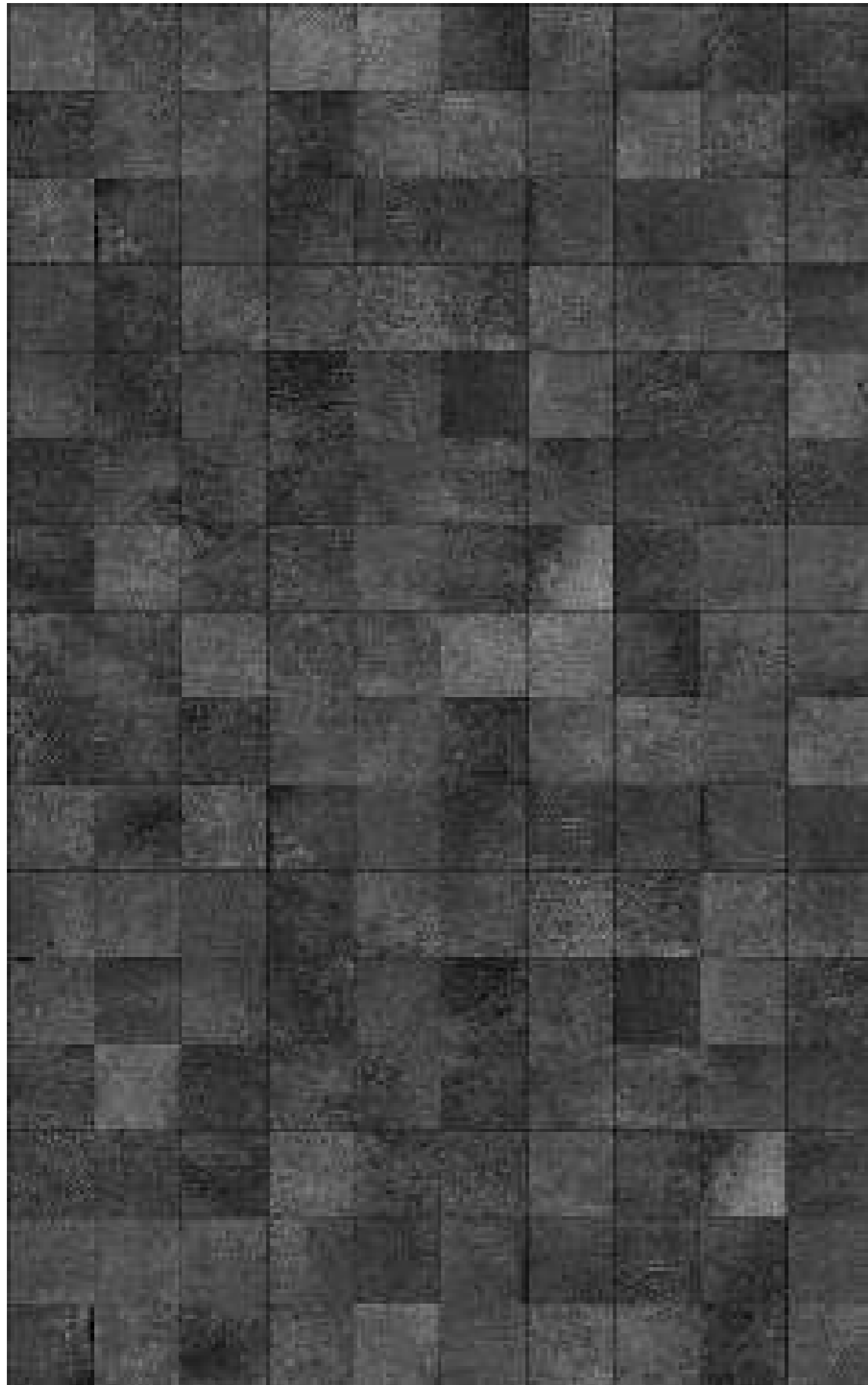

FORMATOS · FORMATS



↗ 30x60cm 12"x24"



■ Volcanic Lava



↗ 14.7x14.7cm 5.8"x5.8"



■ Volcanic Lava

EMBALAJE · PACKING

Formatos Formats	piezas / caja pieces / box	m ² / caja sqm / box	kg / caja kg / box	m ² / palet sqm / pallet	tamaño palet palet size
30x60 [®] cm 12"x24"	8	1,4400	27,00	57,60	120x80x74cm
14.7x14.7 [®] cm 5.8"x5.8" OUT	44	0,9508	16,97	76,06	120x80x89cm

COLORES JUNTA RECOMENDADOS · RECOMMENDED JOINT COLOURS

- Volcanic Lava
- Mapei 114 Anthracite
- Kerakoll 06 Negro
- Litokol Black 1

Media caña exterior
Outer trim

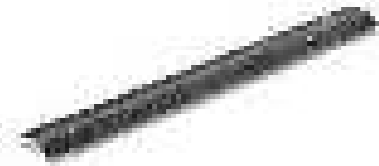

↗ 4.5x50cm 1.8"x19.7"

C3 R11 · Ref. MDCA E000

■ Volcanic Lava

Escocia cantonera exterior
Scotch external corner



↗ 4.5x4.5cm 1.8"x1.8"

C3 R11 · Ref. MDCA EE00

■ Volcanic Lava

Esquina cantonera exterior
Outer angle corner



↗ 6.5x6.5cm 2.5"x2.5"

C3 R11 · Ref. MDCA AE00

■ Volcanic Lava

Media caña interior
Inner trim

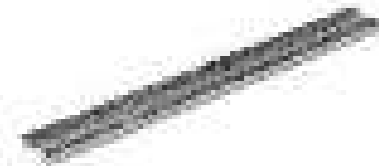

↗ 5.5x50cm 2.1"x19.7"

C3 R11 · Ref. MDCA I000

■ Volcanic Lava

Escocia cantonera interior
Scotch inner corner



↗ 5.5x5.5cm 2.1"x2.1"

C3 R11 · Ref. MDCA EI00

■ Volcanic Lava

Esquina cantonera interior
Inner angle corner



↗ 6.5x6.5cm 2.5"x2.5"

C3 R11 · Ref. MDCA AI00

■ Volcanic Lava

Cantonera transición exterior
External transition corner

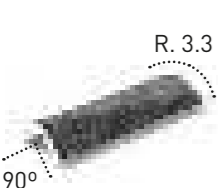

↗ 4.5x16cm 1.8"x6.3"

C3 R11 · Ref. MDCA CE00

■ Volcanic Lava

Cantonera transición interior
Inner transition corner

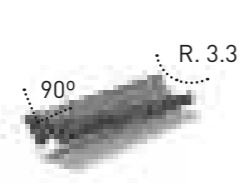

↗ 5.5x16cm 2.1"x6.3"

C3 R11 · Ref. MDCA CI00

■ Volcanic Lava

*Información detallada sobre las piezas de terminación en las páginas 252 y 253.

*Detailed information about trim pieces in pages 252 and 253.

20MM

ESPESOR · THICKNESS

Los pavimentos cerámicos de 20MM de espesor ofrecen una solución robusta y segura, permitiendo su empleo en una amplia variedad de aplicaciones. Presentan la combinación perfecta entre resistencia, durabilidad y versatilidad.

Con un grosor de 20MM, estos suelos cerámicos son capaces de soportar cargas pesadas y resistir el desgaste diario en entornos de alto tránsito, lo que los hace ideales no solo para uso privado, sino también para áreas comerciales, públicas y residenciales donde se requiera una mayor resistencia a la abrasión y al impacto.

20mm thick ceramic floor tiles offer a robust and safe solution, allowing them to be used in a wide variety of applications. They offer the perfect combination of strength, durability and versatility.

With a thickness of 20mm, this ceramic flooring is able to withstand heavy loads and resist daily wear and tear in high traffic environments, making them ideal not only for private use, but also for commercial, public and residential areas where greater resistance to abrasion and impact is required.



60X120X2CM 24"x48"x0.8"

COLORES DISPONIBLES
AVAILABLE COLOURS



Crosscut Petra Crosscut Cloud



Stromboli Light

90X90X2CM 36"x36"x0.8"

COLORES DISPONIBLES
AVAILABLE COLOURS



Savoy Moon Savoy Desert

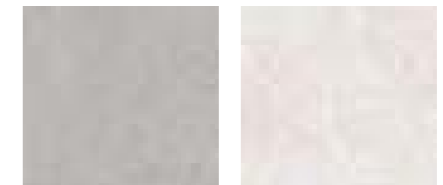

Savoy Land Salem Clar



Sobre plots
On plots

ESPESOR · THICKNESS

El gres porcelánico de 20MM de Cerámica Mayor se desarrolla exclusivamente en acabado para antideslizante para exteriores C3 y se realiza en una amplia selección de colores que son perfectos para ejecutar cualquier proyecto que necesite el plus de antideslizamiento con un acabado y resistencia excepcional.

Cerámica Mayor's 20mm porcelain tile is developed exclusively in C3 non-slip finish for exteriors and is available in a wide selection of colours, which are perfect for any project that needs the added bonus of non-slip with an exceptional finish and resistance.

Este pavimento está diseñado para soportar condiciones adversas, como la constante exposición al sol, a las nevadas o los choques térmicos. Mantiene intacta su apariencia en el tiempo, presentando una baja porosidad, así como una baja absorción de agua. Así, es resistente a zonas constantemente húmedas como las piscinas, además de ser ignífugo, resistente a los químicos y antislip.

This flooring is designed to withstand adverse conditions, such as constant exposure to the sun, snowfall, or thermal shocks. It maintains its appearance intact over time, with low porosity and low water absorption. Thus, it is resistant to constantly wet areas, such as swimming pools, as well as being flame retardant, chemical resistant and anti-slip.



Sobre césped
On grass



Aplicación en terrazas
Terrace application



Aplicación en piscinas
Pool application



Aplicación en jardines
Garden application



Aplicación en parking
Parking application



Aplicación en parques
Application in parks



Aplicación en establecimientos de playas
Application in beach establishments



Sobre grava o arena
On gravel or sand

POOL
SOLUTIONS

TIPOLOGÍAS DE PISCINAS

SWIMMING POOL TYPES

Existen 3 tipos de piscinas según la filtración del agua: desbordantes, infinity y skimmer.

There are 3 types of pools depending on the water filtration: overflow, infinity and skimmer.

SISTEMA DESBORDANTE

Este es uno de los sistemas que mayor continuidad consigue y se ha convertido en un diseño de piscina distintivo y visualmente atractivo que permite que el agua desbordante sea recirculada eficientemente a través de las rejillas de drenaje con canaleta que bordean el vaso.

OVERFLOW SYSTEM

This is one of the systems that achieves the greatest continuity and has become a distinctive and visually appealing pool design. It allows overflowing water to be efficiently recirculated through drain grates that line the pool.

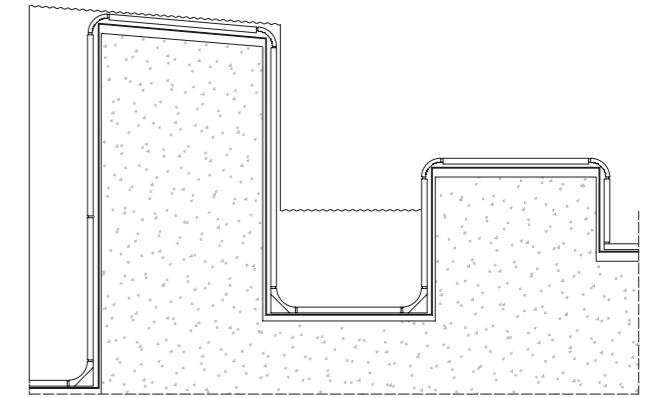
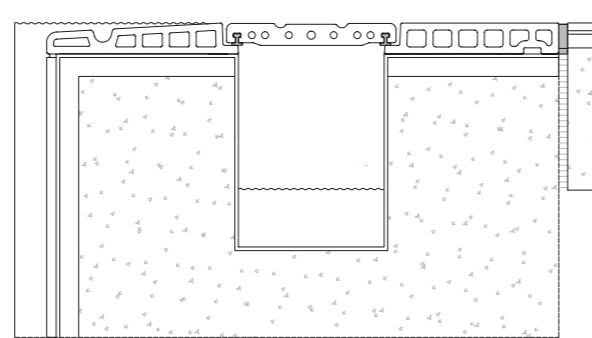

SISTEMA INFINITY

El efecto óptico y la integración con el entorno que producen las piscinas "sin fin" son las principales características por las que son elegidas estas piscinas.

INFINITY SYSTEM

The optical effect and the integration with the environment produced by the "endless" pools are the main characteristics for which these pools are chosen.

SISTEMA SKIMMER

Siendo uno de los sistemas más funcionales y clásicos, las piscinas skimmer también se mantienen atemporales y permiten la filtración del agua por la superficie de esta a través de un skimmer que elimina la suciedad de manera sencilla.

SKIMMER SYSTEM

Being one of the most functional and classic systems, skimmer pools are also timeless and allow the water to be filtered through the surface of the pool by means of a skimmer that easily removes dirt.

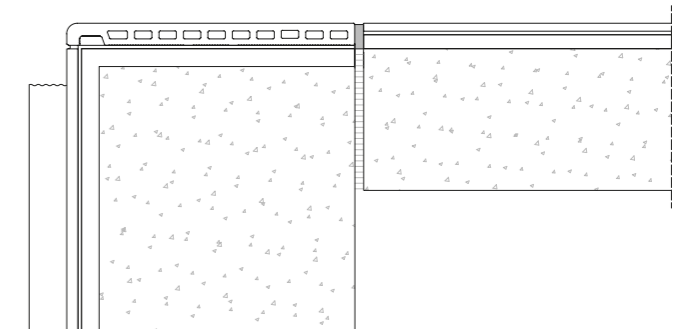

SISTEMA DESBORDANTE

OVERFLOW SYSTEM

Vanguardia y tecnología se funden en estas piscinas donde el agua fluye de manera continua sobre todos los bordes, creando el efecto de desbordamiento deseado donde el agua es dirigida al canal perimetral y es filtrada y recirculada de nuevo hacia la piscina. Estas piscinas son modernas y elegantes, adaptándose a estilos arquitectónicos contemporáneos y consiguiendo la integración en el entorno.

Avant-garde and technology merge in these pools where the water flows continuously over all the edges, creating the desired overflow effect where the water is directed into the perimeter channel and is filtered and recirculated back into the pool. These pools are modern and elegant, adapting to contemporary architectural styles and blending in with their surroundings.



CORONACIÓN CON BORDE DESBORDANTE Y REJILLA DE DRENAJE

Cerámica Mayor ofrece 4 tipos de borde desbordante: Creta, Maui, Bora y Aruba, todos combinables con los 5 tipos de rejillas de drenaje: RJ20, RJ20 FLEX, RJ25, RJ25 FLEX y RJ25 INV.

POOL COPING WITH OVERFLOW EDGE AND DRAIN GRATE

Cerámica Mayor offers 4 types of overflow edge: Creta, Maui, Bora and Aruba, all combinable with the 5 types of drain grates: RJ20, RJ20 FLEX, RJ25, RJ25 FLEX and RJ25 INV.



SISTEMA INFINITY

INFINITY SYSTEM

Haciendo desaparecer el borde en el horizonte, las piscinas infinity se distinguen debido a su perfecta integración en el paisaje circundante, creando un efecto visual impresionante. Con un diseño arquitectónico moderno, estas piscinas de gres porcelánico guían el flujo del agua hacia el canal situado en la zona infinity manteniendo la calidad del agua y el constante desbordamiento de esta.

Making the edge disappear into the horizon, infinity pools are distinguished by their perfect integration into the surrounding landscape, creating a stunning visual effect. With a modern architectural design, these porcelain tile pools guide the flow of water into the channel located in the infinity zone, maintaining the quality of the water as well as its constant overflow.



CORONACIÓN CON MEDIAS CAÑAS

Actualmente Cerámica Mayor ofrece dos tipos de coronación para piscina infinity y las medias cañas son una de ellas, pudiéndose colocar en la zona desbordante ofreciendo un acabado continuo generado por las piezas MDCA I000 y MDCA E000.

POOL COPING WITH TRIMS

Cerámica Mayor currently offers two types of coping for infinity pools and trims are one of them, which can be placed in the overflow area offering a continuous finish generated by the MDCA I000 and MDCA E000 pieces.



CORONACIÓN CON BORDE CRETA

La segunda forma de crear el efecto "sin fin" en la piscina es utilizando el borde Creta en la zona de la coronación y desbordamiento de la piscina, empleando así una única pieza para dar solución de manera sencilla a este tipo de piscinas.

POOL COPING WITH CRETA EDGE

The second way to create the "endless" effect is to use the Creta edge in the pool coping and its overflow area, thus using a single piece to provide a simple solution for this type of pool.



SISTEMA SKIMMER

SKIMMER SYSTEM

Las piscinas skimmer se mantienen atemporales en el tiempo, siendo el estilo más clásico de los tres. Gracias a su sistema de filtrado, el skimmer recoge el agua y elimina los residuos que flotan en la superficie de esta manteniéndola libre de impurezas. Además, mantiene la integración entre el interior de la piscina y el exterior pudiéndose utilizar el mismo color para ambos, logrando así un espacio unificado y moderno.

Skimmer pools remain timeless over time, being the most classic of the three styles. Thanks to its filtering system, the skimmer collects the water and eliminates the waste that floats on the surface, keeping it free of impurities. In addition, it maintains the integration between the interior of the pool and the exterior, and the same colour can be used for both, thus achieving a unified and modern space.

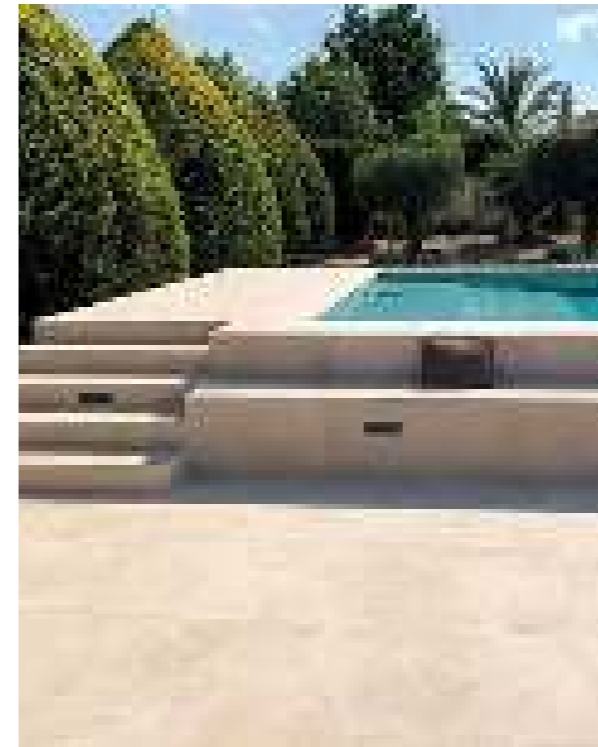

CORONACIÓN CON BORDE DE PISCINA SKIMMER

Aunque es uno de los sistemas más clásicos, el sistema skimmer se mantiene atemporal y Cerámica Mayor ha creado 2 soluciones idóneas para su coronación, los bordes Creta y Samoa, tanto para piscinas reformadas como de nueva obra.

POOL COPING WITH SKIMMER POOL EDGE

Although it is one of the most classic systems, the skimmer system remains timeless. Cerámica Mayor has created 2 ideal solutions for its coping, the Creta edge and Samoa edge, for both refurbished and newly built pools.



CORONACIÓN CON PELDAÑO

Otra de las maneras para coronar una piscina skimmer es con la pieza de peldaño recto cuya geometría permite resolver el ángulo recto generado entre la terraza y la piscina, permitiendo crear piscinas de aspecto moderno y minimalista.

POOL COPING WITH RECTO STEP

Another way for coping a skimmer pool is with the straight step whose geometry allows to solve the right angle generated between the terrace and the pool, allowing to create pools with a modern and minimalist look.

EL VASO DE LA PISCINA

THE POOL VESSEL

El gres porcelánico es el material perfecto para el revestimiento interior de una piscina por su resistencia, versatilidad y durabilidad. Permite integrar distintas soluciones que añaden valor al proyecto y mejoran la funcionalidad y la estética. Una de estas soluciones técnicas son las medias cañas, que permiten la continuidad visual, el acabado antideslizante, la seguridad y la correcta limpieza en el interior de la piscina.

Porcelain tile is the perfect material for the interior lining of a swimming pool due to its resistance, versatility and durability. It allows the integration of different solutions that add value to the project and improve functionality and aesthetics. One of these technical solutions are trims, which allow for visual continuity, a non-slip finish, safety and proper cleaning inside the pool.



SOLUCIÓN CON MEDIAS CAÑAS PARA EL INTERIOR DEL VASO DE LA PISCINA

Cerámica Mayor ofrece 8 tipos distintos de piezas especiales de media caña para el revestimiento interior de la piscina, evitando así los ángulos rectos y ofreciendo la continuidad deseada en el mismo color que el resto de la piscina.

SOLUTION WITH TRIM FOR THE INSIDE OF THE POOL BASIN

Cerámica Mayor offers 8 different types of special trims for the interior lining of the pool, thus avoiding right angles and offering the desired continuity in the same colour as the rest of the pool.



CRETA

BORDE DE PISCINA · POOL EDGE

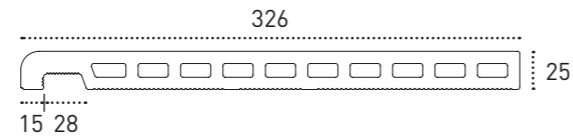
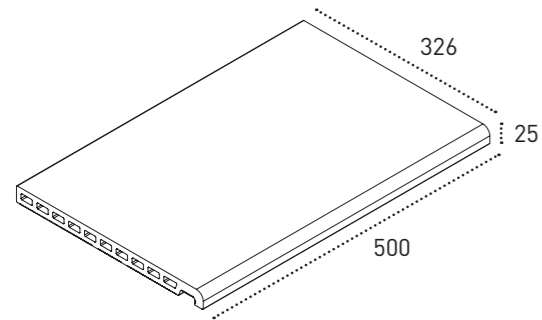

-  33x50cm 13"x19.7"
-  C3 R11 · Ref. BPCR 0000
-  5% 
-  3 caras · 3 sides

COLORES DISPONIBLES · AVAILABLE COLOURS



SOLUCIÓN CURVA · CURVED SOLUTION

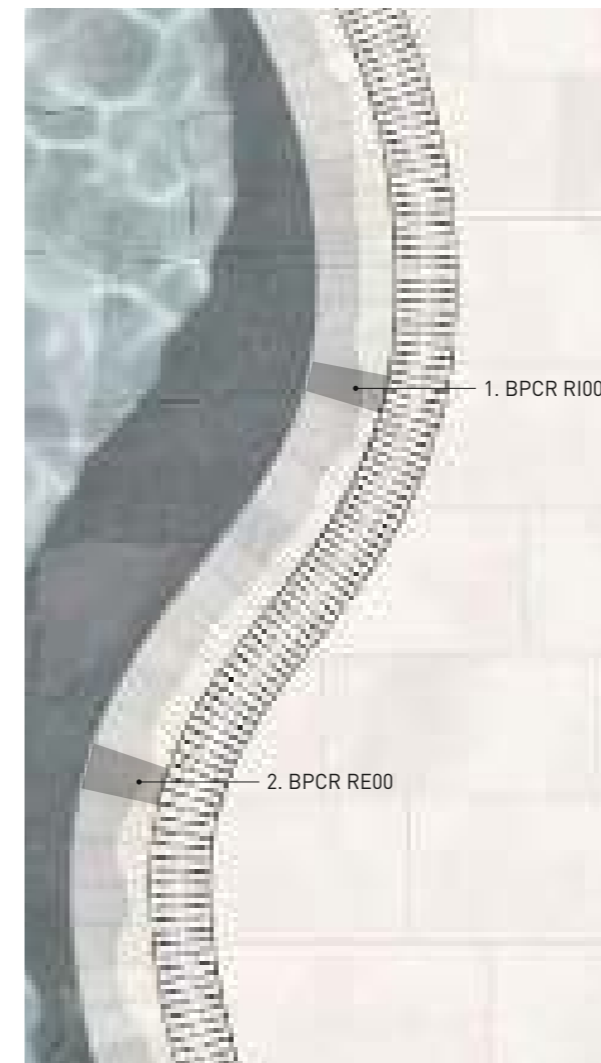

BORDE CURVO CRETA CRETA CURVED EDGE

1. BPCR RI00
2. BPCR RE00

Compatible con las rejillas RJ25, RJ25 FLEX, RJ20, RJ20 FLEX y RJ25 INV
Can be used with drain grates RJ25, RJ25 FLEX, RJ20, RJ20 FLEX and RJ25 INV

SOLUCIÓN ESQUINA · CORNER SOLUTION

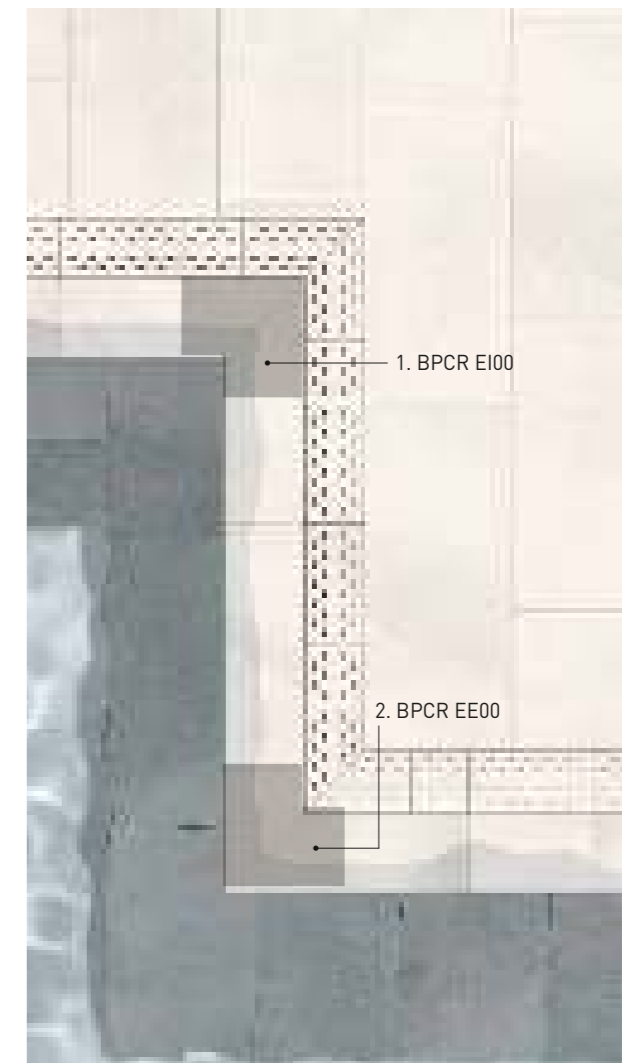

PACK ESQUINA BORDE CRETA (2pcs) CRETA EDGE CORNER PACK (2pcs)

1. BPCR EI00 33x50cm 13"x19.7"
2. BPCR EE00 33x50cm 13"x19.7"

Compatible con las rejillas RJ25, RJ25 FLEX, RJ20, RJ20 FLEX y RJ25 INV
Can be used with drain grates RJ25, RJ25 FLEX, RJ20, RJ20 FLEX and RJ25 INV

INFORMACIÓN TÉCNICA · TECHNICAL INFORMATION

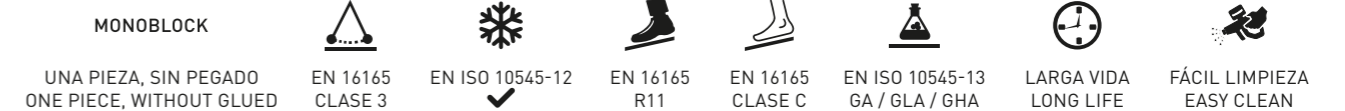

SAMOA

BORDE DE PISCINA · POOL EDGE

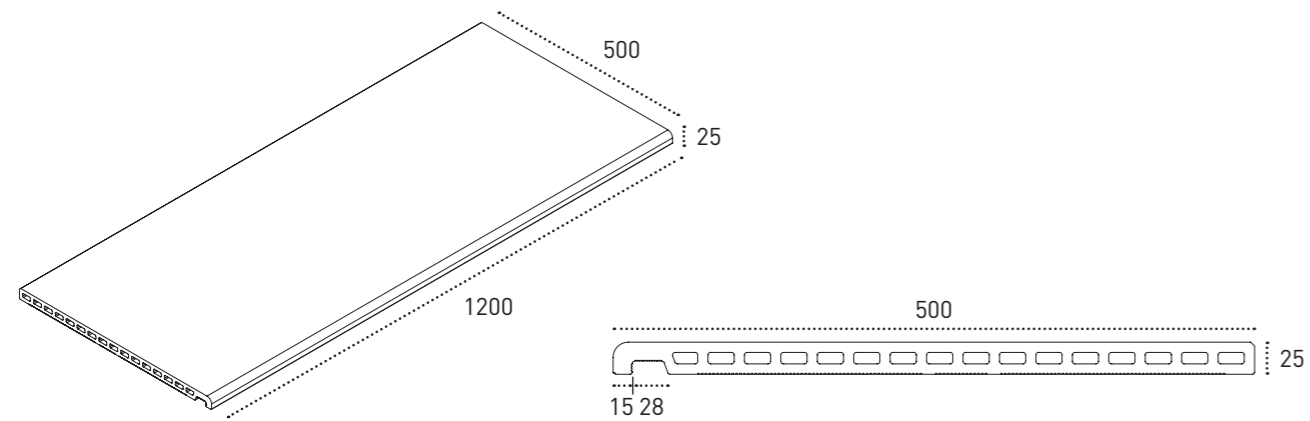

↗ 50x120cm 19.7"x48"

C3 R11 · Ref. BPSA 0000

👁️ 3 caras · 3 sides

COLORES DISPONIBLES · AVAILABLE COLOURS



SOLUCIÓN CURVA · CURVED SOLUTION



BORDE CURVO SAMOA
SAMOA CURVED EDGE

1. BPSA RI00
2. BPSA RE00

SOLUCIÓN ESQUINA · CORNER SOLUTION



PACK ESQUINA BORDE SAMOA (2pcs)
SAMOA EDGE CORNER PACK (2pcs)

1. BPSA EI00 50x120cm 19.7"x48"
2. BPSA EE00 50x120cm 19.7"x48"



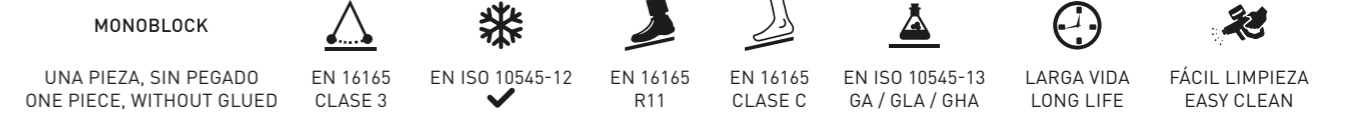

INFORMACIÓN TÉCNICA · TECHNICAL INFORMATION

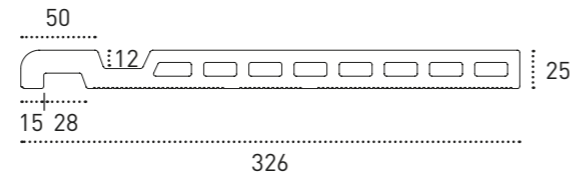
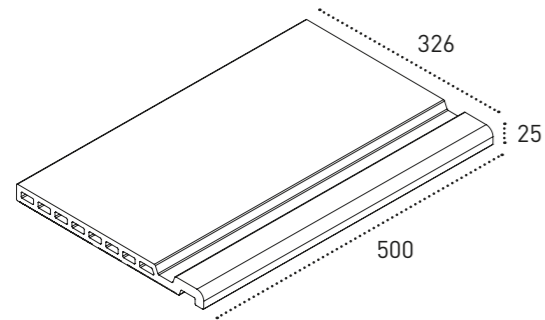

MAUI

BORDE DE PISCINA · POOL EDGE



-  33x50cm 13"x19.7"
-  C3 R11 · Ref. BPMA 0000
-  5% 
-  3 caras · 3 sides

COLORES DISPONIBLES · AVAILABLE COLOURS



SOLUCIÓN CURVA · CURVED SOLUTION

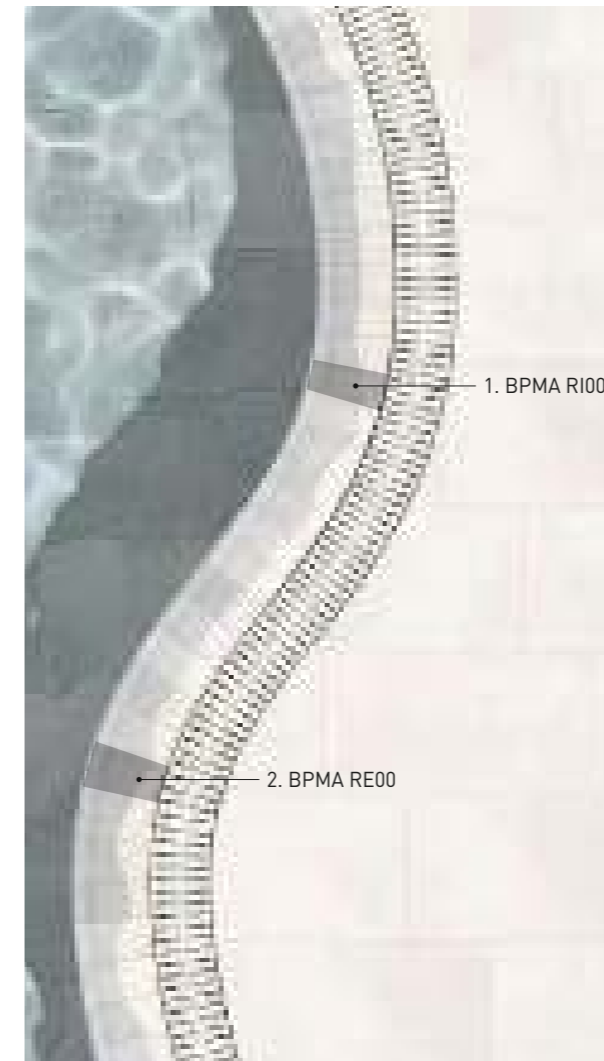

BORDE CURVO MAUI MAUI CURVED EDGE

1. BPMA RI00
2. BPMA RE00

Compatible con las rejillas RJ25, RJ25 FLEX, RJ20, RJ20 FLEX y RJ25 INV
Can be used with drain grates RJ25, RJ25 FLEX, RJ20, RJ20 FLEX and RJ25 INV

SOLUCIÓN ESQUINA · CORNER SOLUTION

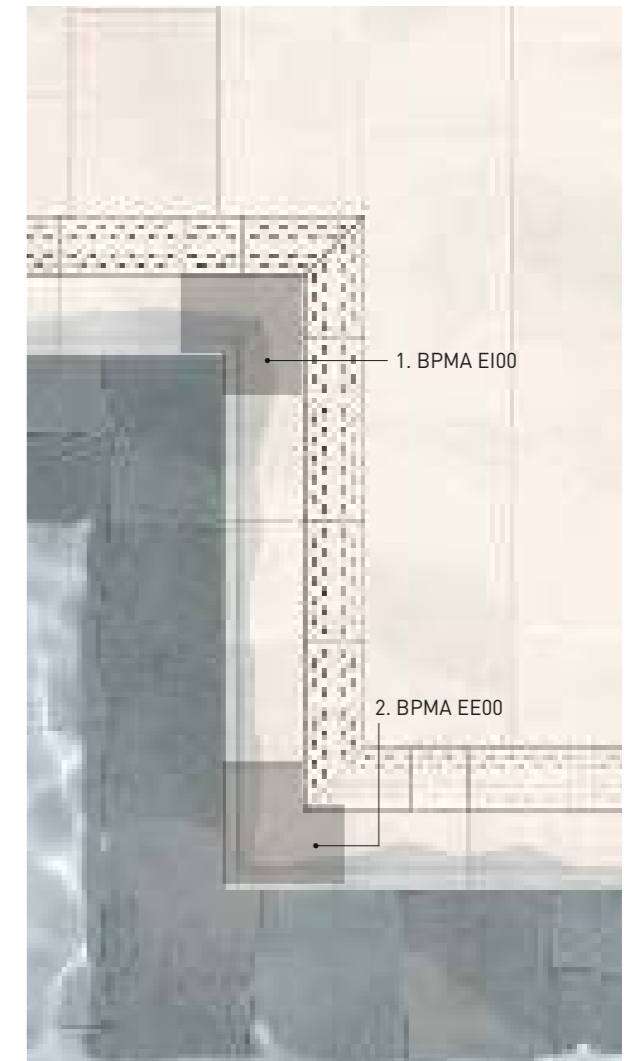







PACK ESQUINA BORDE MAUI (2pcs) MAUI EDGE CORNER PACK (2pcs)

1. BPMA EI00 33x50cm 13"x19.7"
2. BPMA EE00 33x50cm 13"x19.7"

Compatible con las rejillas RJ25, RJ25 FLEX, RJ20, RJ20 FLEX y RJ25 INV
Can be used with drain grates RJ25, RJ25 FLEX, RJ20, RJ20 FLEX and RJ25 INV

INFORMACIÓN TÉCNICA · TECHNICAL INFORMATION

MONOBLOCK							
UNA PIEZA, SIN PEGADO ONE PIECE, WITHOUT GLUED	EN 16165 CLASE 3	EN ISO 10545-12 ✓	EN 16165 R11	EN 16165 CLASE C	EN ISO 10545-13 GA / GLA / GHA	LARGA VIDA LONG LIFE	FÁCIL LIMPIEZA EASY CLEAN

BORDE DE PISCINA · POOL EDGE

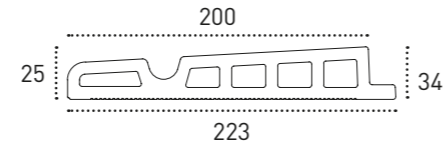
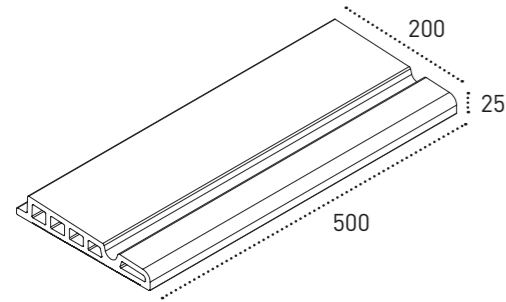

↗ 20x50cm 8"x19.7"

C3 R11 · Ref. BPBO 0000

5%

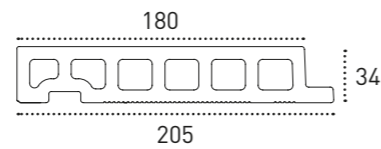
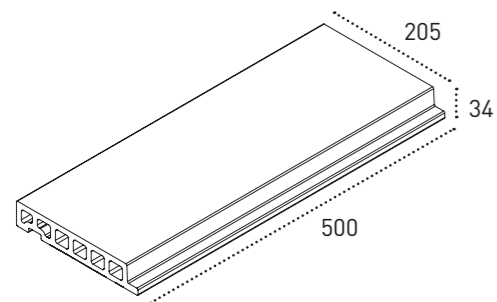

Soporte Canarias
Canarias support

↗ 18x50cm 7"x19.7"

C3 R11 · Ref. BSCA 0000

COLORES DISPONIBLES · AVAILABLE COLOURS

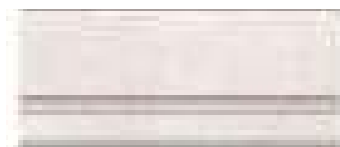

Stromboli Light

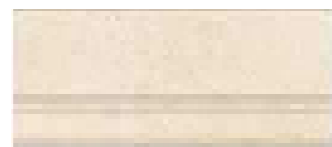

Stromboli Cream



Stromboli Silver

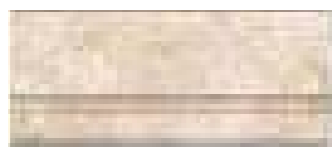

Crosscut Petra

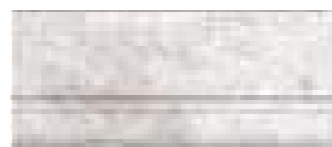

Crosscut Cloud

SOLUCIÓN CURVA · CURVED SOLUTION



BORDE CURVO BORA
BORA CURVED EDGE

1. BPBO RI00
2. BPBO RE00

SOPORTE CURVO CANARIAS PARA REJILLA
CANARIAS CURVED GRATE SUPPORT

3. BSCA RI00
4. BSCA RE00

Ambos son compatibles con las rejillas RJ25, RJ25 FLEX, RJ20, RJ20 FLEX y RJ25 INV
Both can be used with drain grates RJ25, RJ25 FLEX, RJ20, RJ20 FLEX and RJ25 INV

INFORMACIÓN TÉCNICA · TECHNICAL INFORMATION

MONOBLOCK

UNA PIEZA, SIN PEGADO
ONE PIECE, WITHOUT GLUED



EN 16165
CLASE 3



EN ISO 10545-12
✓



EN 16165
R11



EN 16165
CLASE C



EN ISO 10545-13
GA / GLA / GHA



LARGA VIDA
LONG LIFE



FÁCIL LIMPIEZA
EASY CLEAN

SOLUCIÓN ESQUINA · CORNER SOLUTION

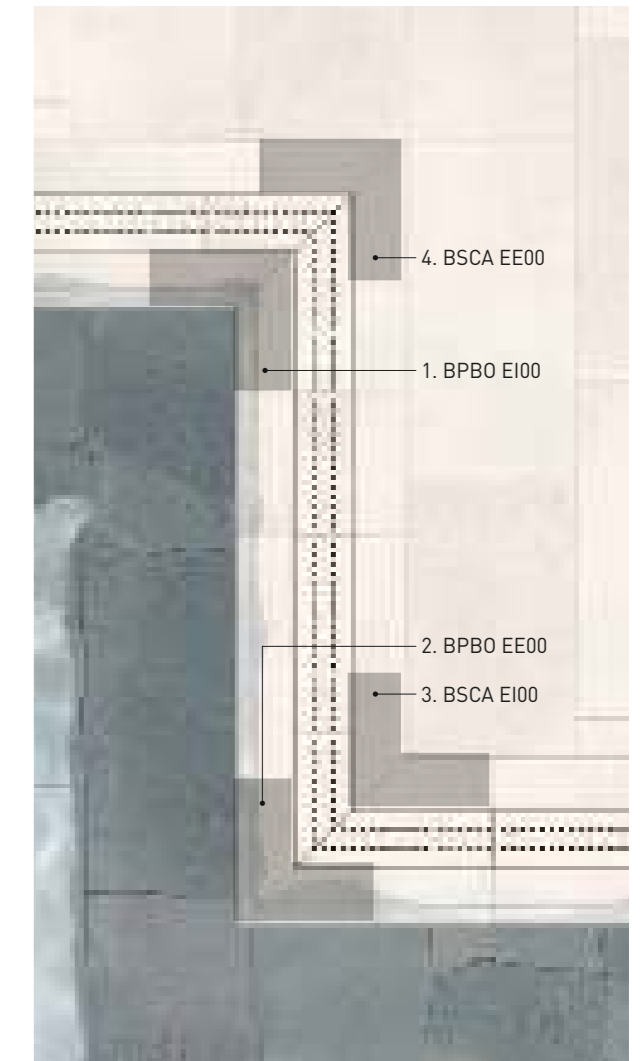

PACK ESQUINA BORDE BORA (2pcs)
BORA EDGE CORNER PACK (2pcs)

1. BPBO EI00 20x50cm 8"x19.7"
2. BPBO EE00 20x50cm 8"x19.7"

PACK SOPORTE ESQUINA CANARIAS P/ REJILLA (2pcs)
CANARIAS CORNER GRATE SUPPORT PACK (2pcs)

3. BSCA EI00 18x50cm 7"x19.7"
4. BSCA EE00 18x50cm 7"x19.7"

Ambos son compatibles con las rejillas RJ25, RJ25 FLEX, RJ20, RJ20 FLEX y RJ25 INV
Both can be used with drain grates RJ25, RJ25 FLEX, RJ20, RJ20 FLEX and RJ25 INV

ARUBA

BORDE DE PISCINA · POOL EDGE

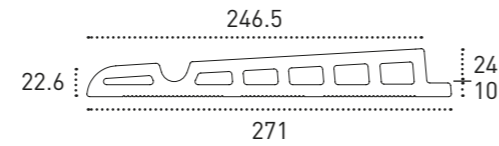
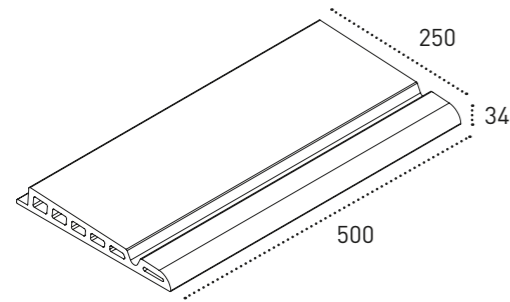

↗ 25x50cm 10"x19.7"

C3 R11 · Ref. BPAR 0000

5% 

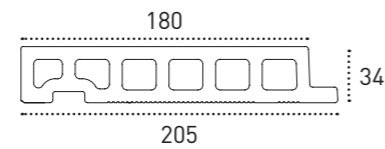
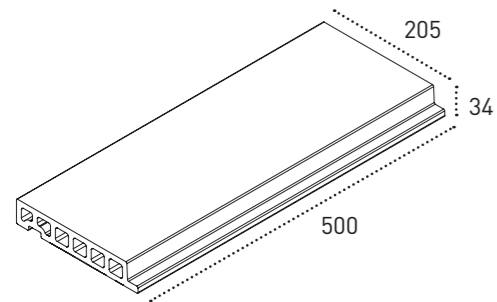

Soporte Canarias
Canarias support

↗ 18x50cm 7"x19.7"

C3 R11 · Ref. BSCA 0000

COLORES DISPONIBLES · AVAILABLE COLOURS

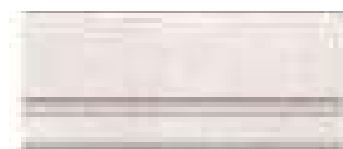

Stromboli Light

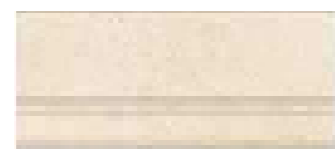

Stromboli Cream



Stromboli Silver

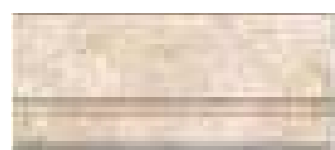

Crosscut Petra



Crosscut Cloud

SOLUCIÓN CURVA · CURVED SOLUTION

BORDE CURVO ARUBA
ARUBA CURVED EDGE

1. BPAR RI00
2. BPAR RE00

SOPORTE CURVO CANARIAS PARA REJILLA
CANARIAS CURVED GRATE SUPPORT

3. BSCA RI00
4. BSCA RE00

Ambos son compatibles con las rejillas RJ25, RJ25 FLEX, RJ20, RJ20 FLEX y RJ25 INV
Both can be used with drain grates RJ25, RJ25 FLEX, RJ20, RJ20 FLEX and RJ25 INV

INFORMACIÓN TÉCNICA · TECHNICAL INFORMATION

MONOBLOCK
UNA PIEZA, SIN PEGADO
ONE PIECE, WITHOUT GLUED



EN 16165
CLASE 3



EN ISO 10545-12
✓



EN 16165
R11



EN 16165
CLASE C



EN ISO 10545-13
GA / GLA / GHA



LARGA VIDA
LONG LIFE



FÁCIL LIMPIEZA
EASY CLEAN

SOLUCIÓN ESQUINA · CORNER SOLUTION

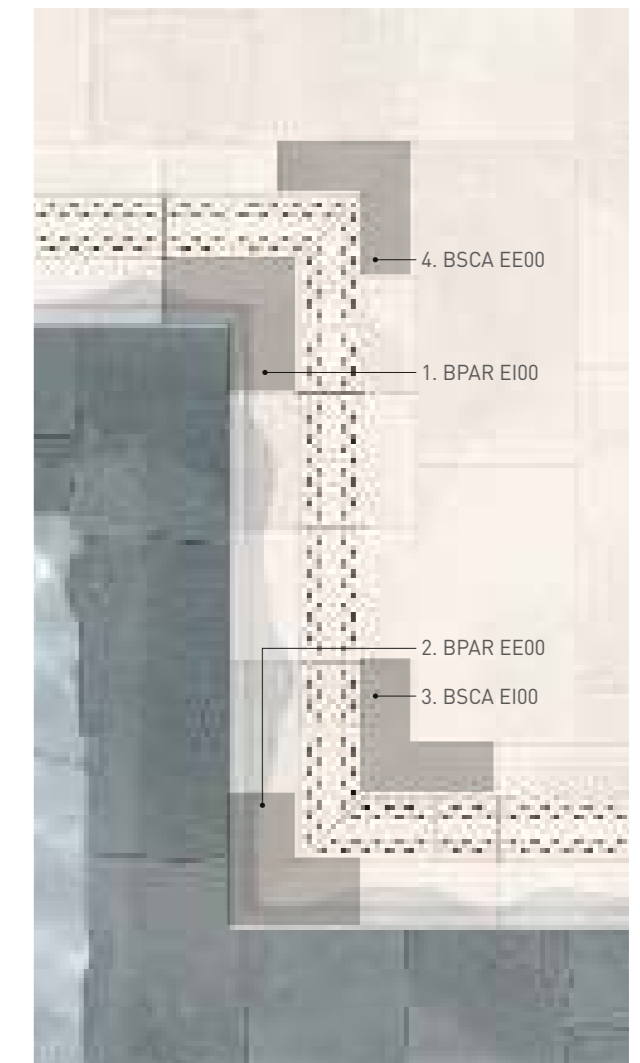
PACK ESQUINA BORDE ARUBA (2pcs)
ARUBA EDGE CORNER PACK (2pcs)

1. BPAR EI00 25x50cm 10"x19.7"
2. BPAR EE00 25x50cm 10"x19.7"

PACK SOPORTE ESQUINA CANARIAS P/ REJILLA (2pcs)
CANARIAS CORNER GRATE SUPPORT (2pcs)

3. BSCA EI00 18x50cm 8"x19.7"
4. BSCA EE00 18x50cm 8"x19.7"

Ambos son compatibles con las rejillas RJ25, RJ25 FLEX, RJ20, RJ20 FLEX y RJ25 INV
Both can be used with drain grates RJ25, RJ25 FLEX, RJ20, RJ20 FLEX and RJ25 INV

RJ25

REJILLA DE DRENAJE CERÁMICA · DRAIN CERAMIC GRATE

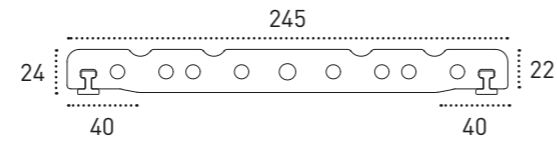
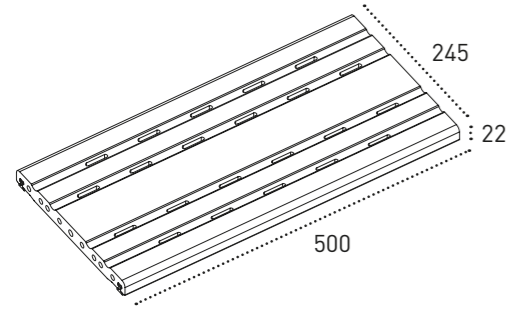

↗ 25x50cm 10"x19.7"

C3 R11 · 🌿 🌐 · Ref. RJ25 0000

Desagüe · Drain: >13m³/hora

Goma para rejilla 9710 incluida
Grate rubber 9710 included

Esquina rejilla de drenaje
Drain grate corner

↗ 25x50cm 10"x19.7"

C3 R11 · 🌿 🌐 · Ref. RJ25 E000

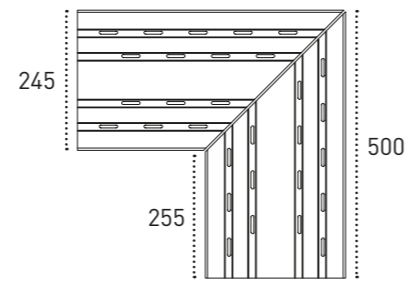

COLORES DISPONIBLES · AVAILABLE COLOURS

Amazonia Miel	Amazonia Canela	Coralina Aguada	Coralina Samaná		
Crosscut Petra	Crosscut Cloud	Iconic Stone	Calacatta Fresh	Salem Clar	Salem Dune
Savoy Moon	Lao Bone	Cupira Hueso	Stromboli Light	Cements Snow	Woods Arctic
Savoy Desert	Lao Sand	Cupira Multi	Stromboli Cream	Cements Warm	Woods Nordic
Savoy Land	Lao Ash	Cupira Marengo	Stromboli Silver	Cements Smoke	Woods Olivo



RJ25 FLEX

REJILLA DE DRENAJE CERÁMICA · DRAIN CERAMIC GRATE

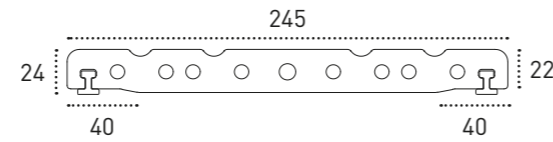
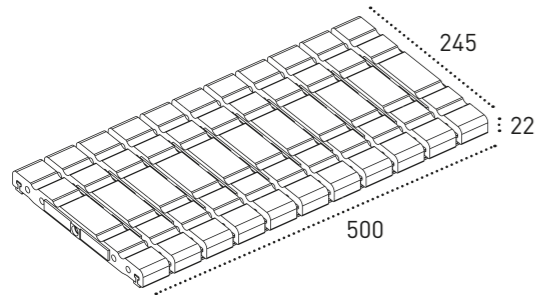

↗ 25x50cm 10"x19.7"

C3 R11 · 🌿 🌐 · Ref. RJ25 FLEX

Desagüe · Drain: >30m³/hora

Goma para rejilla 9710 incluida
Grate rubber 9710 included

Esquina rejilla de drenaje
Drain grate corner

↗ 25x28cm 10"x11"

C3 R11 · 🌿 🌐 · Ref. RJ25 E000 FLEX

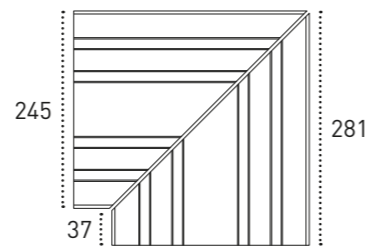

COLORES DISPONIBLES · AVAILABLE COLOURS

Amazonia Miel	Amazonia Canela	Coralina Aguada	Coralina Samaná		
Crosscut Petra	Crosscut Cloud	Iconic Stone	Calacatta Fresh	Salem Clar	Salem Dune
Savoy Moon	Lao Bone	Cupira Hueso	Stromboli Light	Cements Snow	Woods Arctic
Savoy Desert	Lao Sand	Cupira Multi	Stromboli Cream	Cements Warm	Woods Nordic
Savoy Land	Lao Ash	Cupira Marengo	Stromboli Silver	Cements Smoke	Woods Olivo



RJ20

REJILLA DE DRENAJE CERÁMICA · DRAIN CERAMIC GRATE

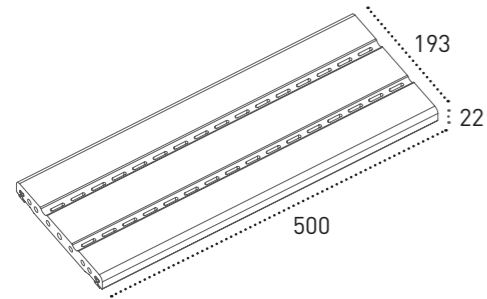

↗ 20x50cm 8"x19.7"

C3 R11 · 🌿 🌐 · Ref. RJ20 0000

Esquina rejilla de drenaje
Drain grate corner

↗ 20x50cm 8"x19.7"

C3 R11 · 🌿 🌐 · Ref. RJ20 E000

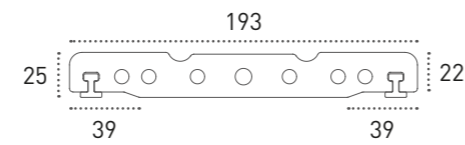

Desagüe · Drain: >11m³/hora

Goma para rejilla 9710 incluida
Grate rubber 9710 included

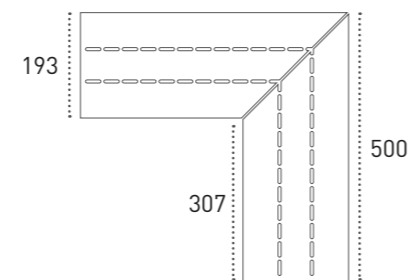

COLORES DISPONIBLES · AVAILABLE COLOURS



Crosscut Petra



Crosscut Cloud



Salem Clar



Stromboli Light



Stromboli Cream

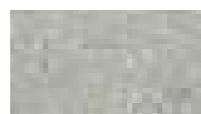

Stromboli Silver



RJ20 FLEX

REJILLA DE DRENAJE CERÁMICA · DRAIN CERAMIC GRATE

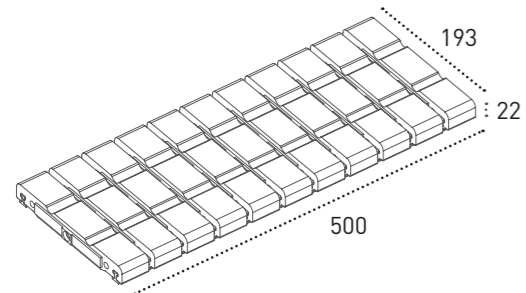

↗ 20x50cm 8"x19.7"

C3 R11 · 🌿 🌐 · Ref. RJ20 FLEX

Esquina rejilla de drenaje
Drain grate corner

↗ 20x23cm 8"x9"

C3 R11 · 🌿 🌐 · Ref. RJ20 E000 FLEX

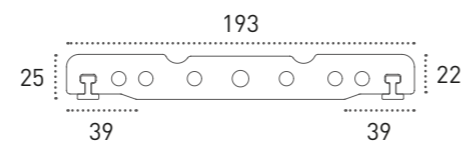

Desagüe · Drain: >30m³/hora

Goma para rejilla 9710 incluida
Grate rubber 9710 included

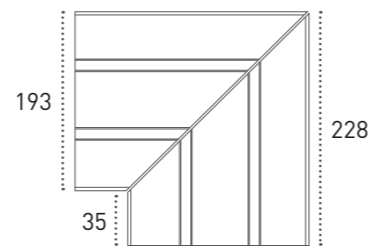

COLORES DISPONIBLES · AVAILABLE COLOURS



Crosscut Petra



Crosscut Cloud



Salem Clar



Stromboli Light



Stromboli Cream

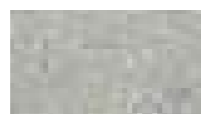

Stromboli Silver



RJ25 INVISIBLE

REJILLA DE DRENAJE CERÁMICA · DRAIN CERAMIC GRATE

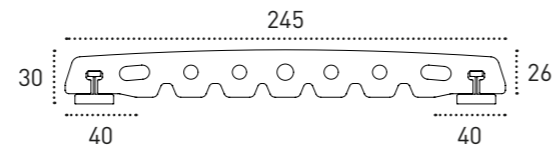
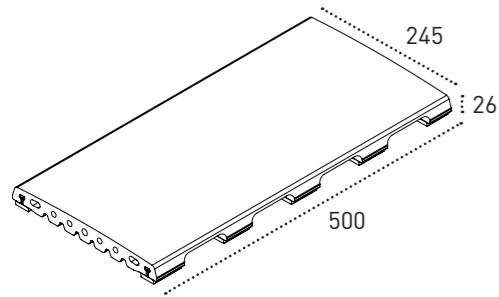

↗ 25x50cm 10"x19.7"

C3 R11 · 🌿 🌐 · Ref. RJ25 0000 INV

Desagüe · Drain: >8m³/hora

Goma para rejilla 12719 incluida
Grate rubber 12719 included

Esquina rejilla de drenaje
Drain grate corner

↗ 25x50cm 10"x19.7"

C3 R11 · 🌿 🌐 · Ref. RJ25 E000 INV

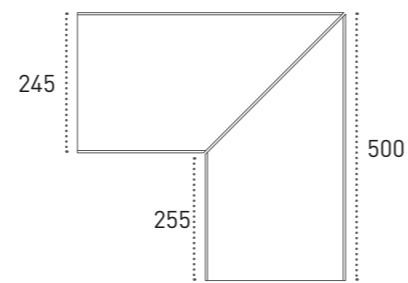

COLORES DISPONIBLES · AVAILABLE COLOURS

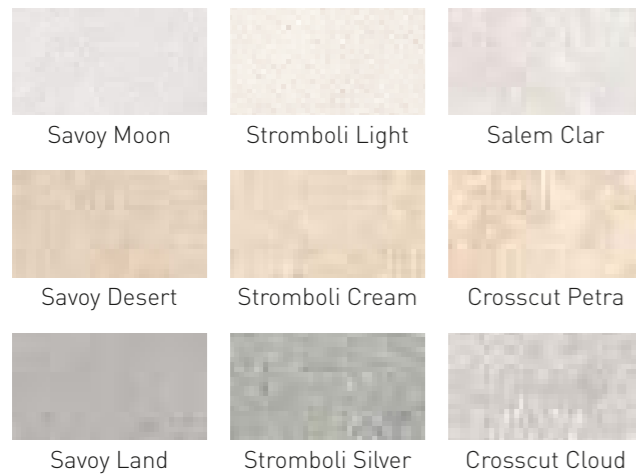

MEDIA CAÑA

TRIM

1. Media caña exterior · Outer trim

↗ 4.5x50cm 1.8"x19.7"
Ref. MDCA E000

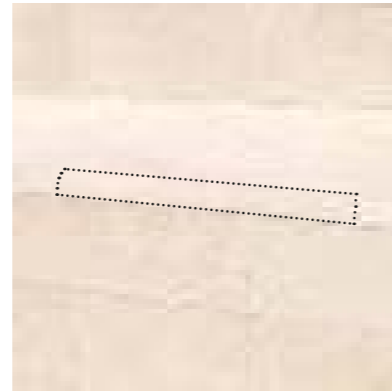
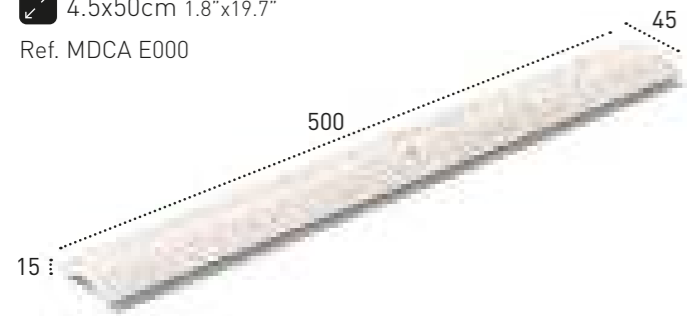

2. Media caña interior · Inner trim

↗ 5.5x50cm 2.1"x19.7"
Ref. MDCA I000

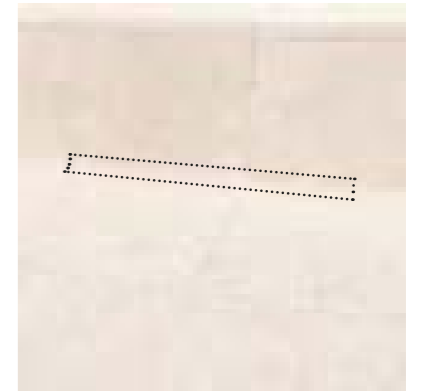
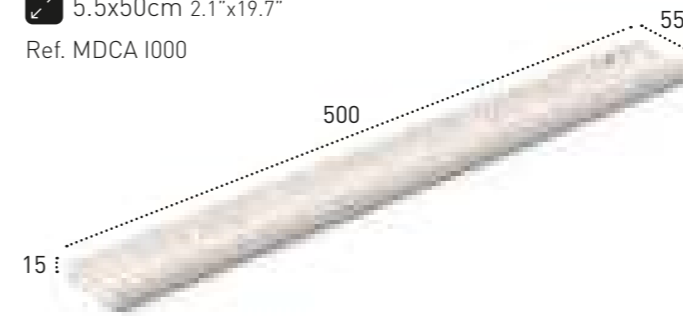

3. Escocia cantonera exterior · Scoth outer corner

↗ 4.5x4.5cm 1.8"x1.8"
Ref. MDCA EE00

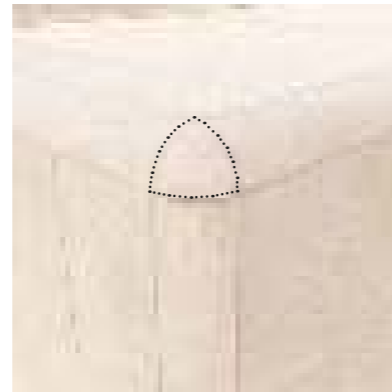
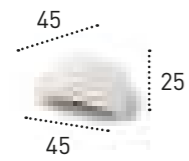

4. Escocia cantonera interior · Scoth inner corner

↗ 5.5x5.5cm 2.1"x2.1"
Ref. MDCA EI00

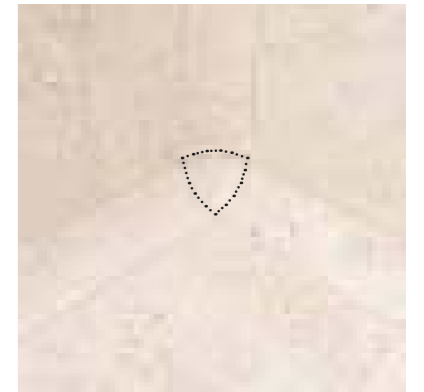

5. Esquina cantonera exterior · Outer angle corner

↗ 6.5x6.5cm 2.5"x2.5"
Ref. MDCA AE00

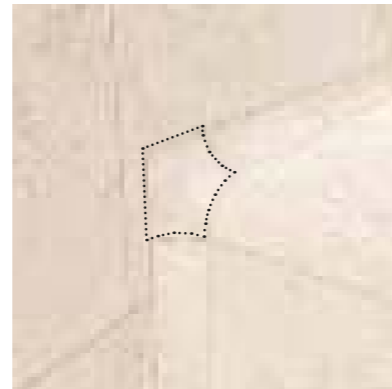
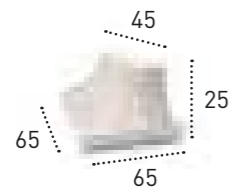

6. Esquina cantonera interior · Inner angle corner

↗ 6.5x6.5cm 2.5"x2.5"
Ref. MDCA AI00

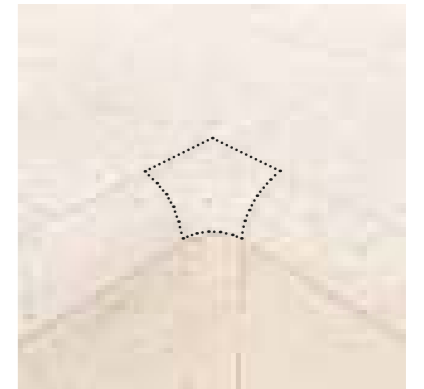
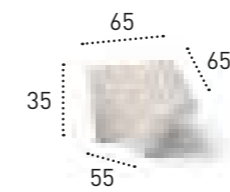

7. Cantonera transición exterior · External transition corner

↗ 4.5x16cm 1.8"x6.3"
Ref. MDCA CE00

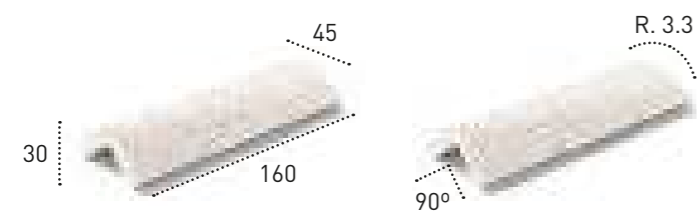

8. Cantonera transición interior · Inner transition corner

↗ 5.5x16cm 2.1"x6.3"
Ref. MDCA CI00

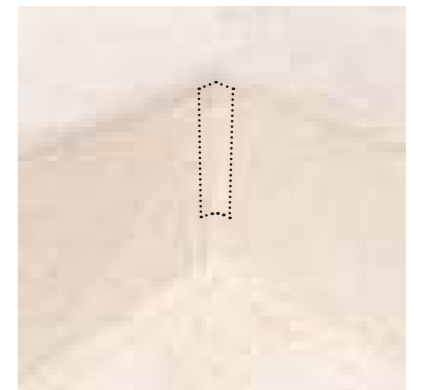
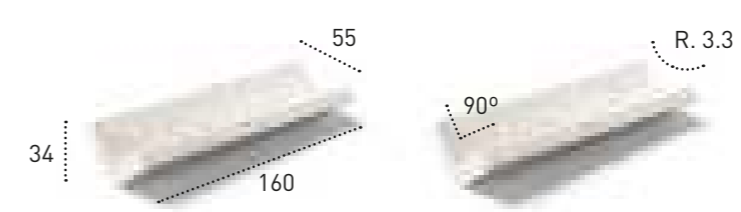



COLORES DISPONIBLES · AVAILABLE COLOURS

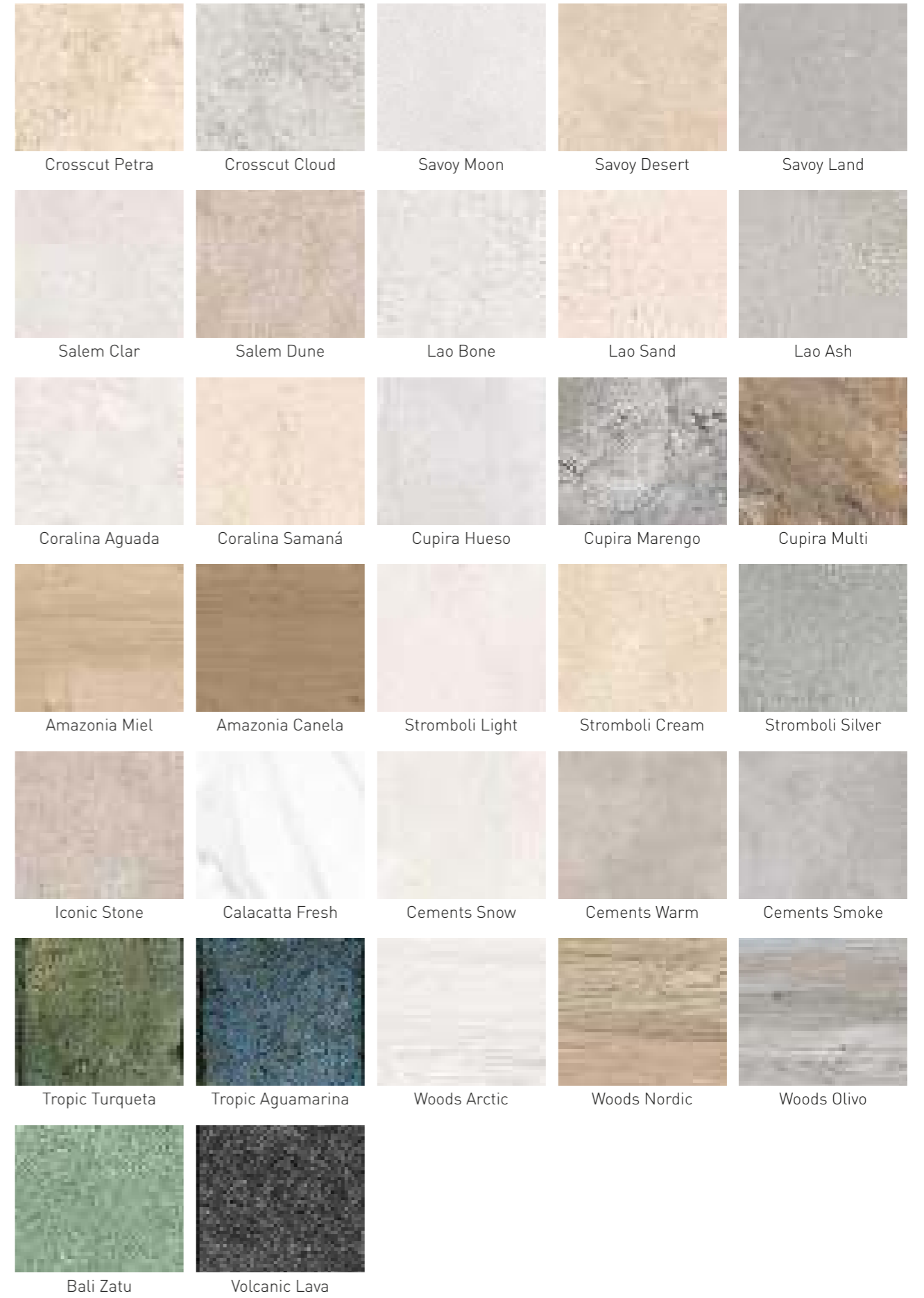

MONTAJE DE PELDAÑOS · STEP FITTING INDICATIONS

**PLANIFICACIÓN**

Nos aseguraremos de que las medidas de nuestro material encajan en la escalera. Debemos tener en cuenta todo tipo de juntas: estructurales, perimetrales, de dilatación, y de colocación.

SETTING-OUT ON SITE

We recommend to ensure that all the tiles fit properly at the stairs. At this point, it is important to consider all the necessary joints: expansion joints, perimeter joints, tile-to-tile joints and structural joints.

**SUPERFICIE Y ENCOLADO**

La superficie debe estar bien conformada y seca. Eliminamos cualquier resto de suciedad. El adhesivo se extiende sobre el escalón de obra y sobre el peldaño. A continuación, colocamos el peldaño totalmente apoyado sobre la escalera.

SURFACE AND ADHESIVE METHOD

The support surface should be well-formed, clean and dry. The adhesive is spread both, on the back side of the step tile and on the support. Then, the step tile should be positioned completely resting on the support.

**IMPORTANTE**

Para una correcta instalación de los peldaños es necesario utilizar junta elástica impermeable y cemento cola flexible. Comprobamos las piezas y ajustamos los niveles.

IMPORTANT

We recommend to use appropriate bonding materials: the adhesive should be high-adherence and flexible and the grouts past should be waterproof and elastic. The level should be checked and adjusted.

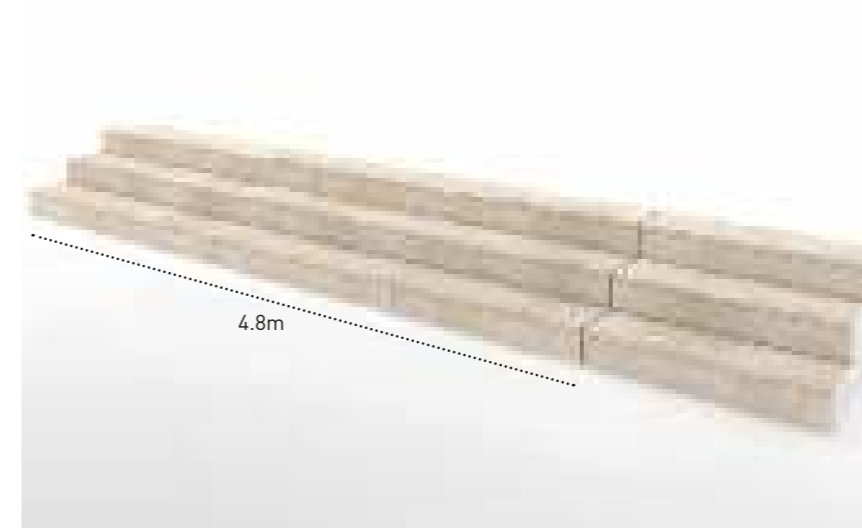
**JUNTAS**

Junta entre peldaños entre 6 y 10mm.

La junta de dilatación debe hacerse cada 4 metros.

JOINTS

We recommend to use a tile-to-tile joint between 6 and 10mm.

We recommend to install an expansion joint each 4m.

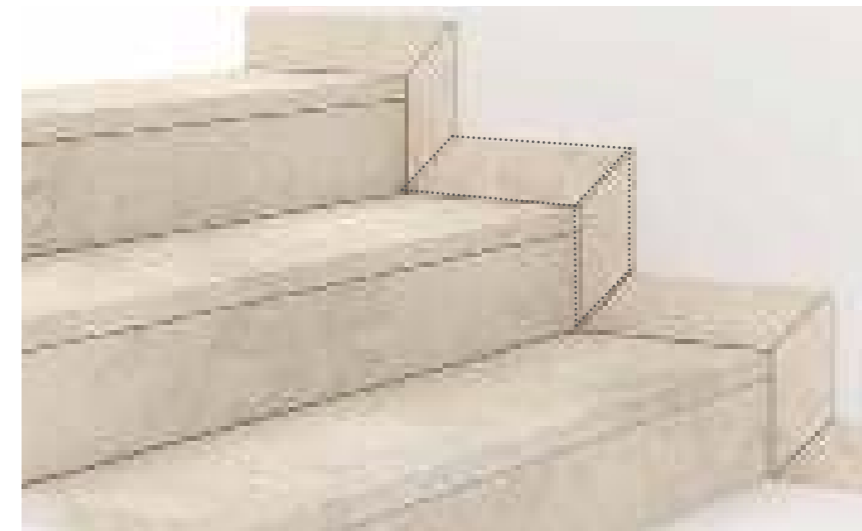
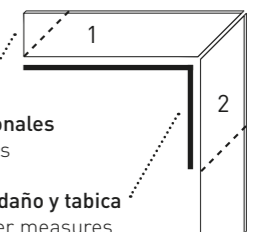
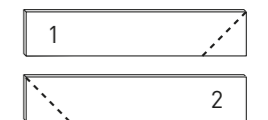
**EL RODAPIÉ COMO SOLUCIÓN PARA ZANQUINES****SKIRTING BOARD APPLICATIONS**

Cortes diagonales
Diagonal cuts

Medidas peldaño y tabica
Step and riser measures

MANUAL COLOCACIÓN PIEZAS CERÁMICAS EN PISCINAS

PROCEDURE FOR CERAMIC PLACEMENT IN POOLS

Una vez se haya ejecutado el vaso de la piscina y preparado el soporte para recibir el material cerámico, Cerámica Mayor sugiere seguir los siguientes pasos para conseguir una correcta ejecución en la colocación de las piezas especiales de borde.

Once we have prepared the pool vessel, Cerámica Mayor suggests the following steps to achieve a correct execution in the placement of special pieces for pool edges.

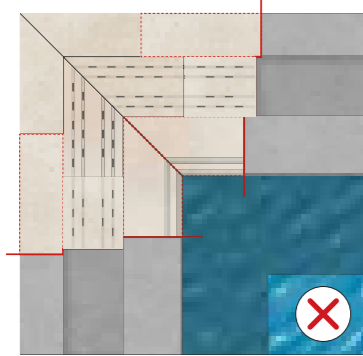

Una colocación incorrecta puede producir roturas en las piezas.
Incorrect alignment or placement of the pieces can cause breakages in pieces.

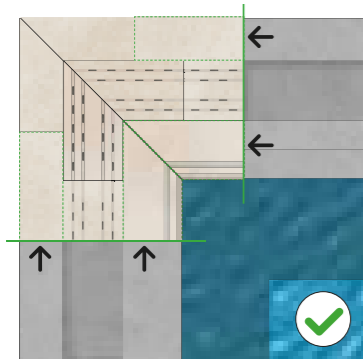

Alineación correcta de las piezas. Estas piezas se deberán de cortar y ajustar en obra.
Correct alignment of pieces. These pieces must be cut and adjusted on-site.

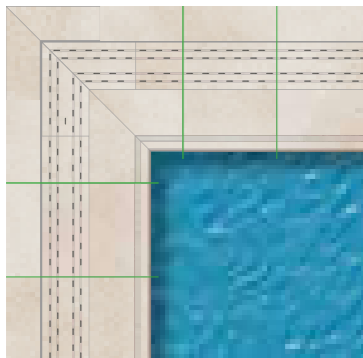

La colocación de las piezas deberá de empezar de los extremos hacia el centro de cada uno de los lados, manteniendo la linealidad de las piezas.
The placement of the pieces must start from the corners to the center of each side, keeping the linearity of the pieces.

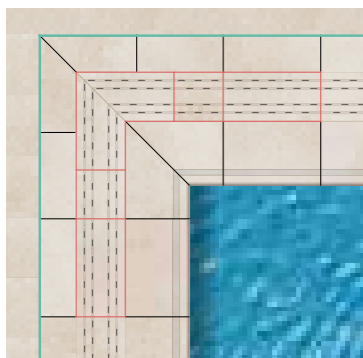

Las juntas de expansión son muy importantes en la colocación de las piezas para evitar posibles roturas.
Cerámica Mayor recomienda:
● Junta abierta mínima 4mm
● Junta cerrada mínima 4mm
● Junta de dilatación

The expansion joints are very important to ensure correct ceramic pieces placement and to avoid possible breakages.
Cerámica Mayor recommends:
● Open joint minimum 4 mm size
● Closed joint minimum 4 mm size
● Expansion joint

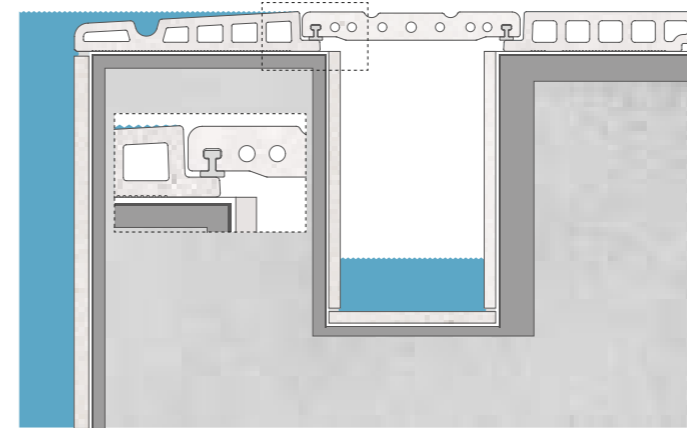

La rejilla deberá apoyar en las pestañas del borde y del soporte, colocando siempre la goma proporcionada por Cerámica Mayor. Nunca se debe de colocar la rejilla sin junta debido a las contracciones y dilataciones que pueden sufrir las piezas. Se debe emplear mortero cola flexible, estanco y antiácido para la colocación del borde y soporte.

The drain grate must be placed over the edge and support flanges, and always with the rubber provided by Cerámica Mayor. The drain grate should never be placed without joints due to the contractions and dilatations that pieces may suffer. Flexible, watertight and anti-acid tail mortar must be used for correct edge and support placement.

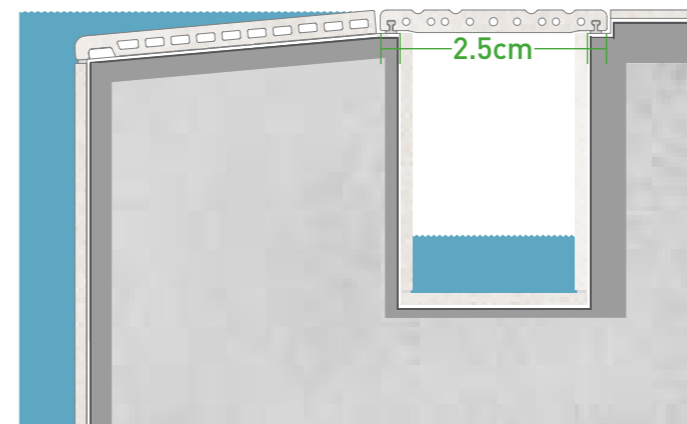

En el caso de que el borde no tenga pestaña y, además, no se utilice soporte, la rejilla apoyará al menos 2,5cm en cada uno de sus extremos. Nunca se debe de colocar la rejilla sin junta debido a las contracciones y dilataciones que pueden sufrir las piezas. Se debe emplear mortero cola flexible, estanco y antiácido para la colocación del borde.

In case the edge has no flange and, in addition, no support is used, the drain grate shall be supported by at least 2.5 cm at each end. The drain grate should never be placed without joints due to the contractions and dilatations that pieces may suffer. Flexible, watertight and anti-acid tail mortar must be used for correct edge placement.

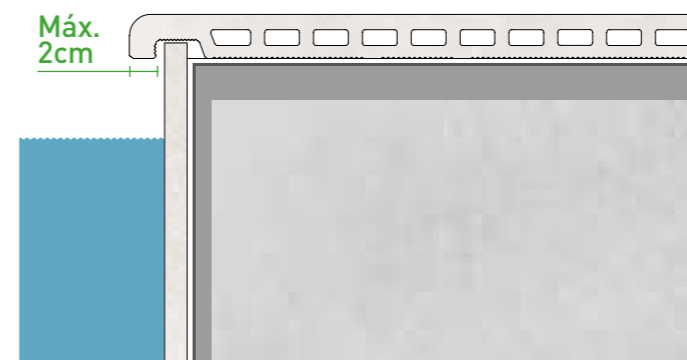

Cerámica Mayor sugiere que la pieza de borde no sobresalga más de 2cm respecto el paramento vertical del vaso de la piscina. Un excesivo vuelo de la pieza podrá provocar una rotura en la misma.

Cerámica Mayor suggests that the edge pieces never protrude more than 2 cm beyond the vertical wall of the pool shell.

SISTEMA BLOCK 25

BLOCK 25 SYSTEM

MONTAJE DEL SISTEMA BLOCK 25 · ASSEMBLY OF THE BLOCK 25 SYSTEM

El sistema Block 25 de Cerámica Mayor se compone de un conjunto de bloques de hormigón prefabricado hidrófugo cuyo objetivo principal es dejar preparada la superficie de coronación de la piscina para recibir las piezas cerámicas.

The Block 25 system by Cerámica Mayor consists of a set of prefabricated water-repellent concrete blocks whose main purpose is to prepare the pool coping surface to receive the ceramic pieces.

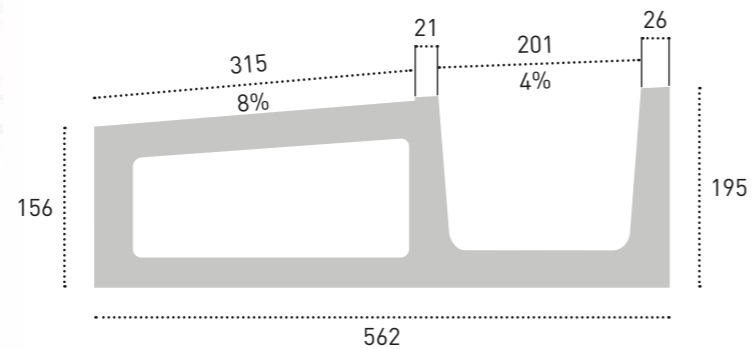

Este sistema permite ejecutar con rapidez cualquier tipo de proyecto de piscina, desde las más pequeñas en viviendas privadas a las más grandes en lujosos hoteles.

This system allows any type of swimming pool project to be carried out quickly, from the smallest in private homes to the largest in luxury hotels.

Block 25 se integra perfectamente con nuestros bordes de piscina Creta y Maui y nuestras rejillas de drenaje cerámicas de 25cm de anchura, como lo son las rejillas RJ25, RJ25 FLEX y RJ25 INV.

Block 25 integrates perfectly with our Creta and Maui pool edges and our 25cm wide ceramic drainage gratings, such as RJ25, RJ25 FLEX and RJ25 INV.

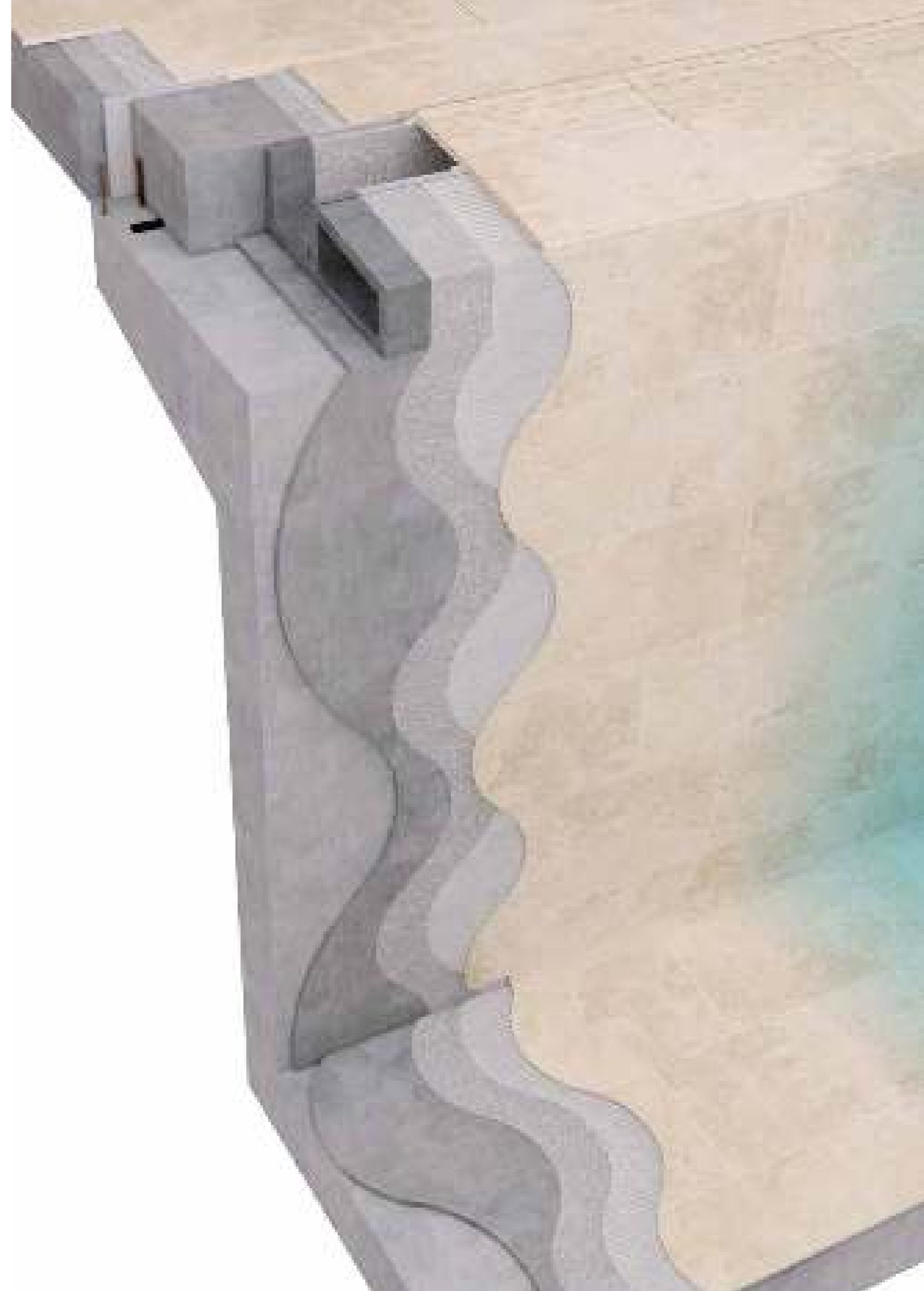

PROCEDIMIENTO PARA LA COLOCACIÓN

PROCEDURE FOR PLACEMENT

ES

AVISO IMPORTANTE ANTES DE LA PUESTA EN OBRA:

- Verificar que la calidad de la figura impresa en el embalaje se corresponde con la del material solicitado.
- Verificar la ausencia de defectos visibles (baldosas de 1ª calidad).
- Se recomienda, al colocar, mezclar piezas de varias cajas.
- No se admitirán reclamaciones de problemas derivados del incumplimiento de estas premisas cuando el material ya esté colocado.

PARA CUALQUIER RECLAMACIÓN ES NECESARIA LA REFERENCIA DE LA CAJA

PREPARACIÓN DE LOS MATERIALES

- Cemento de agarre
- Nivel manual y elementos de medición necesarios
- Cuñas de nivelación
- Cruquetas
- Pasta de rejunte
- Paleta
- Llana dentada
- Productos de limpieza

COMPROBAR LA CORRECTA NIVELACIÓN DEL SOPORTE

En terrazas y espacios exteriores es muy importante evacuar el agua correctamente para evitar que ésta quede estancada en la superficie. Cerámica Mayor recomienda lo siguiente:

- Imprescindible dar una pendiente mínima que esté comprendida entre el 1-3%.
- Se deberán colocar los suficientes canales sumideros para que no existan problemas de evacuación de aguas pluviales.
- El terreno tendrá que estar correctamente impermeabilizado y drenado para evitar el ascenso del agua por capilaridad.
- Se deberá de utilizar mortero de nivelación, también conocido como autonivelante con el fin de obtener un soporte sólido preparado para recibir las piezas de gres porcelánico.

LIMPIEZA DE LA SUPERFICIE

Se deberá de comprobar que la superficie esté exenta de restos de otros materiales tales como residuos de cemento, grasas, polvo, etc.

REPLANTEO DE LA SUPERFICIE

Con el fin de aprovechar al máximo el material cerámico se deberá de establecer una línea principal a partir de la cual se iniciará la colocación. En el replanteo se tendrán que tener en cuenta:

- Juntas perimetrales: Tendrá que ser > 5,00mm.
- Juntas estructurales: Deberán de coincidir con las juntas estructurales del edificio y serán como mínimo de 10mm y tendrán que ser de un material flexible.

■ Junta de partición: En áreas entre 20-30m² o 6-8ml se requerirá de una junta de partición de > 5,00mm.

■ Juntas de colocación: Para la colocación de Material Rectificado se requiere una junta de colocación >2,50 mm. Para la colocación de Material No Rectificado se requiere una junta de colocación >4,00mm, y además, se colocarán de forma trabada o en espiga (no se colocarán a más de 1/4 de su dimensión)

ELECCIÓN Y COLOCACIÓN DEL MATERIAL DE AGARRE

El material adhesivo a utilizar será cemento cola flexible C-2 TE S2 apropiado para la instalación de pavimento de gres porcelánico.

C: Adhesivo cementoso

2: Adhesivo mejorado

T: Adhesivo con deslizamiento reducido

E: Adhesivo con tiempo abierto ampliado

S2: Adhesivo altamente deformable

Una vez preparada la mezcla siguiendo las instrucciones del fabricante del producto, extenderemos con la ayuda de una llana dentada el cemento de agarre sobre la superficie previamente compacta y nivelada.

Se deberá extender también cemento de agarre en la parte posterior de la pieza con una llana dentada, generando de esta forma un doble encolado.

INSTALACIÓN DE LA PIEZA CERÁMICA

Con la ayuda de una maza de goma flexible se fijará la baldosa cerámica eliminando posibles burbujas de aire producidas por el material de agarre.

ELECCIÓN Y COLOCACIÓN DE MATERIAL DE REJUNTE

El material de rejunte a utilizar en las juntas perimetrales, juntas de colocación y juntas de partición sera rejuntado cementoso mejorado tipo CG2.

Una vez preparada la mezcla, siguiendo las instrucciones del fabricante del producto, extenderemos el material de rejuntado entre la separación de las piezas y se fijará con la ayuda de una llana de rejuntado.

20x120 · 30x120 · 30x60 · 60x120 · 37.5x75

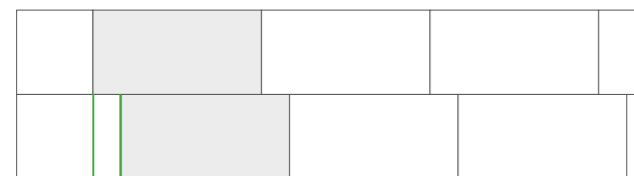

MAX. 20CM

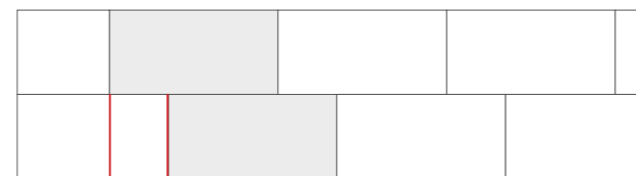

MORE THAN 20CM

EN

IMPORTANT BEFORE STARTING INSTALLATION, PLEASE NOTE THE FOLLOWING:

- Verify that the received material is what the customer ordered.
- Ensure that there are no important physical defects (in 1st quality material).
- It is recommended to mix pieces from several boxes when setting.
- Claims will not be accepted when the above conditions have not been fulfilled and the material has been installed. THE BOX REFERENCE WILL BE NECESSARY FOR ANY CLAIM

PREPARATION OF MATERIALS

- Grip cement
- Spirit level and measuring elements
- Levelling wedges
- Auto-levelling spacers
- Grouting material
- Trowel
- Serrated trowel
- Cleaning products

CHECK THE CORRECT LEVELLING OF THE SUPPORT

On terraces and outdoor spaces it is very important to drain water correctly to prevent it from stagnating on the surface. Cerámica Mayor recommends the following:

- It is essential to provide a minimum slope of between 1-3%.
- Sufficient drainage channels should be installed to avoid rainwater drainage problems.
- The ground must be properly waterproofed and drained to prevent water rising by capillary action.
- Levelling mortar or also known as self-levelling mortar must be used to achieve a solid substrate ready to receive the stoneware tiles.

SURFACE CLEANLINESS

The surface must be checked to ensure that it is free of other materials such as cement residues, grease, dust, etc.

LAYING OUT THE SURFACE.

In order to avoid the wastage of material, a main line should be established from which the tile installation will begin. In the layout, the following must be taken into account:

- Perimeter joints: These should be > 5.00mm.
- Structural joints: These shall coincide with the structural joints of the building and shall be at least 10mm and be made of a flexible material.

■ Partition joint: In areas between 20-30m² or 6-8ml a partition joint of > 5.00mm will be required.

■ Tile joints: For the installation of Rectified Material, a tile joint >2.50mm is required. For the installation of Not Rectified Material is necessary a tile joint >4.00mm, and in addition, they shall be installed in a random laying or herringbone manner (they shall not be installed at more than 1/4 of their dimension).

CHOICE AND INSTALLATION OF THE BONDING MATERIAL

The adhesive material to be used shall be C-2 TE S2 flexible cementitious adhesive suitable for the installation of porcelain stoneware flooring.

C: Cementitious adhesive

2: Improved adhesive

T: Reduced slip adhesive

E: Adhesive with extended open time

S2: Highly deformable adhesive

Once the mixture has been prepared according to the product manufacturer's instructions, spread the bonding cement on the previously compacted and levelled surface with the help of a notched trowel.

The bonding cement should also be spread on the back of the workpiece with a notched trowel, thus creating a double bond.

INSTALLATION OF THE CERAMIC TILE

With the help of a flexible rubber mallet, the ceramic tile will be fixed, eliminating possible air bubbles produced by the bonding material.

CHOICE AND INSTALLATION OF GROUT.

The grout material to be used in the perimeter joints, tile joints and partition joints shall be CG2 type improved cementitious grout.

Once the mixture has been prepared, following the product manufacturer's instructions, spread the grout between the separation of the pieces and fix it with the help of a grout trowel.



Escanea este QR y visualiza nuestro manual de limpieza tras la colocación.

Scan this QR and view our cleaning manual after installation.

DIMENSIONES DE LAS PIEZAS

PIECES DIMENSIONS



↗ 14.7x14.7cm 5.8"x5.8"
 ↓ 0.8cm 0.3"
 C3 R11 · 3-C



↗ 14.7x14.7cm 5.8"x5.8"
 ↓ 0.83cm 0.32"
 C1 R9 · 1-A

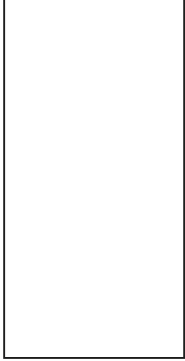

↗ 60x120cm 24"x48"
 ↓ 1.02cm 0.4"
 C3 R11 · C1 R9 · R
 3-C 1-A

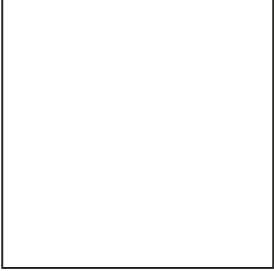

↗ 90x90cm 36"x36"
 ↓ 0.9cm 0.35"
 C3 R11 · C1 R9 · R
 3-C 1-A



↗ 60x120cm 24"x48"
 ↓ 2cm 0.8"
 C3 R11 · R 3-C



↗ 90x90cm 36"x36"
 ↓ 2cm 0.8"
 C3 R11 · R 3-C



↗ 20x120cm 8"x48"
 ↓ 0.9cm 0.35"
 C3 R11 · C1 R9 · R
 3-C 1-A



↗ 30x120cm 12"x48"
 ↓ 0.9cm 0.35"
 C3 R11 · C1 R9 · R
 3-C 1-A

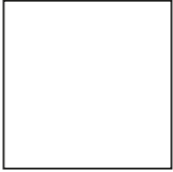

↗ 60x60cm 24"x24"
 ↓ 0.9cm 0.35"
 C3 R11 · C1 R9 · R
 3-C 1-A



↗ 30x60cm 12"x24"
 ↓ 0.9cm 0.35"
 C3 R11 · R
 3-C

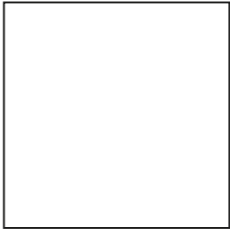

↗ 75x75cm 30"x30"
 ↓ 0.9cm 0.35"
 C3 R11 · C1 R9 · R
 3-C 1-A



↗ 37.5x75cm 15"x30"
 ↓ 0.9cm 0.35"
 C3 R11 · R
 3-C



↗ 120x120cm 48"x48"
 ↓ 0.9cm 0.35"
 C3 R11 · C1 R9 · R
 3-C 1-A

PELDAÑOS

STEPS

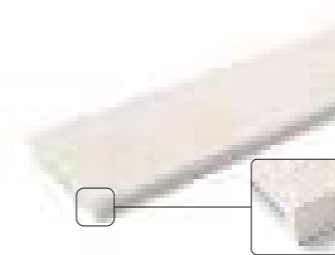

Peldaño recto
 Recto step
 ↗ 33x120cm 13"x48"
 ↓ 3.4cm 1.3"
 ↓ 1.1cm 0.43"
 C3 R11 · C1 R9

MONOBLOCK
 Una pieza, sin pegado
 One piece, without glued



Peldaño recto tapa
 Recto step corner
 ↗ 33x120cm 13"x48"
 ↓ 3.4cm 1.3"
 ↓ 1.1cm 0.43"
 C3 R11 · C1 R9







Peldaño completo
 Full step
 ↗ 33x120cm 13"x48"
 ↓ 2.4cm 0.95"
 C3 R11

MONOBLOCK
 Una pieza, sin pegado
 One piece, without glued

INFORMACIÓN TÉCNICA DE LAS BASES

TECHNICAL INFORMATION OF THE BASES

	Resistencia a la abrasión Resistance to surface abrasion	EN ISO 10545-7 PEI IV-V		Resistencia a las manchas Stain resistance	EN ISO 10545-14 5
	Resistencia a la helada Frost resistance	EN ISO 10545-12		Resistencia química Chemical resistance	EN ISO 10545-13 GA/GLA/GHA
	Resistencia al choque térmico Thermal shock resistance	EN ISO 10545-9		Resistencia al rayado · OUT Scratch resistance · OUT	UNE 67101 9
	Resistencia a la flexión Bending strenght	EN ISO 10545-4 >23N/mm ²		Absorción de agua Water absortion	EN ISO 10545-3 <0,5%
	Antideslizante · OUT Antislip · OUT	Deslizamiento EN 16165 · Clase 3		Resistencia al fuego Fire resistance	CLASE A1fl Sin necesidad de ensayo (Decisión 96/603/ECC Modificada)
	Antideslizante · OUT Antislip · OUT	EN 16165 R11		Resistencia al impacto Impact resistance	EN ISO 10545-5
	Antideslizante · OUT Antislip · OUT	EN 16165 Clase C		Tolerancia dimensional Dimensional tolerance	✓

PACKING LIST | 2024

	Inches	pieces/box	sqm/box	kg/box	kg/pallet gross	sqm/pallet	pieces/pallet	pallet size	PROSCUT	SAVOY	TEONIC	cupilla	SALIDA	CORUINA	CLAUDETTA	ENERBA	STROMBOLI	CERAMICS	AMAZONIA	WOODS	TRONIC	VALANC	MAIJC		
BASE 30x60 [®] cm - OUT	12" x 24"	8	1,4400	40	27,00	1,100	57,60	320	120x80x74																
BASE 60x60 [®] cm - OUT	24" x 24"	4	1,4400	32	27,00	950	44,08	128	120x80x74																
BASE 60x60 [®] cm - IN	24" x 24"	4	1,4400	32	27,00	950	44,08	128	120x80x74																
BASE 37,5x75 [®] cm - OUT	15" x 30"	4	1,1250	55	23,50	1,320	61,87	220	120x80x89																
BASE 75x75 [®] cm - OUT	30" x 30"	2	1,1250	48	23,50	1,160	54,00	96	120x80x90																
BASE 20x120 [®] cm - IN	30" x 30"	2	1,1250	48	23,50	1,160	54,00	96	120x80x90																
BASE 20x120 [®] cm - IN	8" x 48"	7	1,6800	44	34,54	1,520	73,92	308	120x80x83																
BASE 20x120 [®] cm - OUT	8" x 48"	7	1,6800	44	34,54	1,520	73,92	308	120x80x83																
BASE 30x120 [®] cm - OUT	12" x 48"	4	1,4400	36	33,37	1,334	57,60	160	120x80x74																
BASE 30x120 [®] cm - IN	12" x 48"	4	1,4400	36	33,37	1,334	57,60	160	120x80x74																
BASE 60x120 [®] cm - OUT	24" x 48"	2	1,4400	32	31,65	1,033	46,08	64	120x84x74																
BASE 60x120 [®] cm - IN	24" x 48"	2	1,4400	32	31,65	1,033	46,08	64	120x84x74																
BASE 90x90 [®] cm - OUT	36" x 36"	2	1,6200	30	32,50	1,035	48,60	60	106x95x74																
BASE 90x90 [®] cm - IN	36" x 36"	2	1,6200	30	32,50	1,035	48,60	60	106x95x74																
BASE 120x120 [®] cm - OUT	48" x 48"	1	1,4400	40	31,00	1,265	57,6	40	125x125x69																
BASE 120x120 [®] cm - IN	48" x 48"	1	1,4400	40	31,00	1,265	57,6	40	125x125x69																
BASE 60x120 [®] cm de 2 cm - OUT	24" x 48"	1	0,7200	27	34,37	928	19,44	27	120x84x74																
BASE 90x90 [®] cm de 2 cm - OUT	36" x 36"	1	0,8100	27	39	1,080	21,87	27	105x95x84																
BASE 14,7x14,7 [®] cm - IN	5,8" x 5,8"	44	0,9508	80	16,97	1,357	74,06	3,520	120x80x89																
BASE 14,7x14,7 [®] cm - OUT	5,8" x 5,8"	44	0,9508	80	16,97	1,357	74,06	3,520	120x80x89																
RECTO STEP 120x33 cm - OUT	13" x 48"	2	-	32	23,18	742	-	64	125x104x15																
RECTO STEP 1 COVER 120x33 cm - OUT	13" x 48"	1	-	32	11,59	371	-	32	125x104x15																
RECTO STEP 2 COVERS 120x33 cm - OUT	13" x 48"	1	-	32	12,00	386	-	32	125x104x15																
RECTO STEP 120x33 cm - IN	13" x 48"	2	-	32	23,18	742	-	64	125x104x15																
RECTO STEP 1 COVER 120x33 cm - IN	13" x 48"	1	-	32	11,59	371	-	32	125x104x15																
RECTO STEP 2 COVERS 120x33 cm - IN	13" x 48"	1	-	32	12,00	386	-	32	125x104x15																
FULL STEP 120x33 cm - OUT	13" x 48"	2	-	40	32,40	1,296	-	80	125x104x15																
ZANQUIN RECTO 9x45 cm (D/I)	3,5" x 17,7"	8 set	-	99	19,20	1,901	-	792 set	-																
ZANQUIN COMPLETO 9x45 cm (D/I)	3,5" x 17,7"	8 set	-	99	19,21	1,902	-	792 set	-																
SKIRTING BOARD 9x40 cm	3,5" x 24"	10	-	108	15,36	1,658	-	1,080	110x95x96																
RISER 14,5x120 cm	5,3" x 48"	6	-	75	22,20	1,665	-	450	125x110x90																
SAMOA	19,6" x 48"	1	-	42	25,50	1,071	-	42	125x110x64																
SAMOA EDGE - Ref. BPSA 0000 50x120		1 set	-	-	-	-	-	-	-																
SAMOA CORNER PACK		/radio	-	-	-	-	-	-	-																
SAMOA CURVED EDGE		1 set	-	-	-	-	-	-	-																
Ref. BPSA E00 50x120 / BPSA E100 50x120																									
Ref. BPSA RE00 50x... / BPSA R100 50x...																									
CRETA	13" x 19,6"	2	-	60	13,40	816	-	120	110x95x80																
CRETA EDGE - Ref. BPCR 0000 33x50		1 set	-	-	-	-	-	-	-																
CRETA CORNER PACK		/radio	-	-	-	-	-	-	-																
Ref. BPCR E00 33x50 / BPCR E100 33x50																									
Ref. BPCR RE00 33x... / BPCR R100 33x...																									

DATE: 01/01/2024

FLOOR TILES



POOL



	Inches	pieces/box	sqm/box	kg/box	kg/pallet gross	sqm/pallet	pieces/pallet	pallet size	PROSCUT	SAVOY	TEONIC	cupilla	SALIDA	CORUINA	CLAUDETTA	ENERBA	STROMBOLI	CERAMICS	AMAZONIA	WOODS	TRONIC	VALANC	MAIJC	
MAUI	13" x 19,6"	2	-	60	13,30	798	-	120	110x95x80															
MAUI EDGE - Ref. BPSA 0000 33x50		1 set	-	-	-	-	-	-	-															
MAUI CORNER PACK		/radio	-	-	-	-	-	-	-															
Ref. BPSA E00 33x50 / BPSA E100 33x50																								
Ref. BPSA RE00 33x... / BPSA R100 33x...																								
BORA	8" x 19,6"	2	-	104	9,20	957	-	208	110x95x90															
BORA EDGE - Ref. BPSA 0000 20x50		1 set	-	-	-	-	-	-	-															
BORA CORNER PACK		/radio	-	-	-	-	-	-	-															
Ref. BPSA E00 20x50 / BPSA E100 20x50																								
Ref. BPSA RE00 20x... / BPSA R100 20x...																								
ARUBA	10" x 19,6"	2	-	66	11,35	750	-	132	110x95x90															
ARUBA EDGE - Ref. BPAR 0000 25x50		1 set	-	-	-	-	-	-	-															
ARUBA CORNER PACK		/radio	-	-	-	-	-	-	-															
Ref. BPAR E00 25x50 / BPAR E100 25x50																								
Ref. BPAR RE00 25x... / BPAR R100 25x...																								
SUPPORT	7" x 19,6"	2	-	88	9,32	820	-	176	110x95x90															
CANARIAS SUPPORT - Ref. BSCA 0000 18x50		1 set	-	-	-	-	-	-	-															
CANARIAS CORNER PACK		/radio	-	-	-	-	-	-	-															
Ref. BSCA E00 18x50 / BSCA E100 18x50																								
Ref. BSCA RE00 18x... / BSCA R100 18x...																								
RJ25 INV	10" x 19,6"	2	-	96	9,60	922	-	192	110x105x90															



Crosscut Petra Out C3 · In C1



Crosscut Cloud Out C3 · In C1



Iconic Stone Out C3 · In C1



Savoy Moon Out C3 · In C1

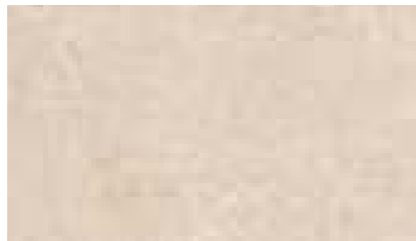

Savoy Dessert Out C3 · In C1



Savoy Land Out C3 · In C1



Lao Bone Out C3 · In C1



Lao Sand Out C3 · In C1



Lao Ash Out C3 · In C1



Cupira Hueso Out C3 · In C1

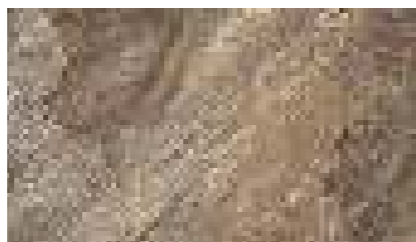

Cupira Multi Out C3



Cupira Marengo Out C3



Salem Clar Out C3 · In C1



Salem Dune Out C3 · In C1



Calacatta Fresh Out C3 · In C1



Eterna Alba Out C3 · In C1



Eterna Argent Out C3 · In C1



Eterna Cendra Out C3 · In C1



Stromboli Light Out C3 · In C1



Stromboli Cream Out C3 · In C1



Stromboli Silver Out C3 · In C1



Cements Snow Out C3 · In C1



Cements Warm Out C3 · In C1



Cements Smoke Out C3 · In C1



Amazonia Miel Out C3 · In C1

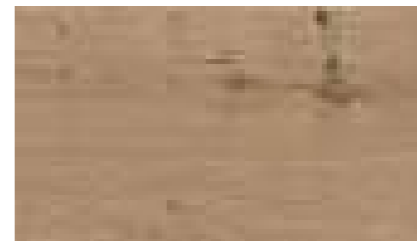

Amazonia Canela Out C3 · In C1



Bali Zatu Out C3

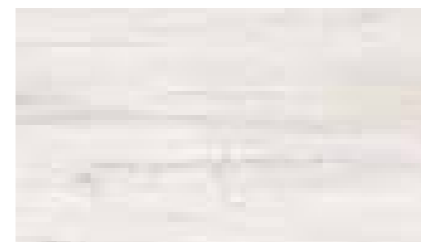

Woods Arctic Out C3 · In C1



Woods Nordic Out C3 · In C1



Woods Olivo Out C3 · In C1



Coralina Aguada Out C3 · In C1



Coralina Samaná Out C3 · In C1

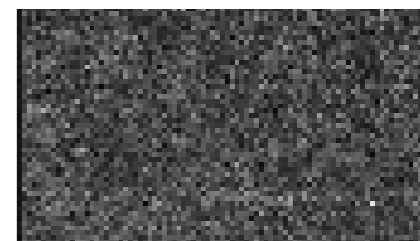

Volcanic Lava Out C3



Tropic Turqueta Out C3 · In C1

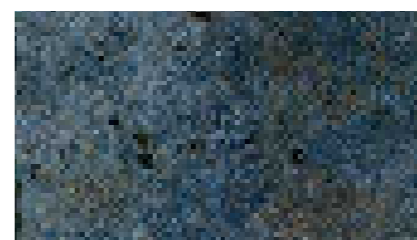

Tropic Aguamarina Out C3 · In C1

CERÁMICA MAYOR, S.A.

Dirección: Partida Planet, s/n. Callosa d'en Sarrià, Alicante,
España (03510)

Centro logístico: Poligono Industrial Supoi 8, Av. Boverot, 12,
12550 Almassora, Castellón

Teléfono: +34 965 881 175

Web: www.ceramicamayor.com

e-mail: info@ceramicamayor.com



Cerámica Mayor se reserva el derecho de hacer las modificaciones que considere oportunas. Debido a los procesos de impresión, los colores que aparecen en este catálogo deben considerarse aproximados, no exactos.

Toda la información de este catálogo está protegida por copyright. Está prohibida la reproducción total o parcial de los textos, imágenes y representaciones gráficas sin la autorización expresa de Cerámica Mayor.

Los ambientes que se muestran en este catálogo son sugerencias decorativas de carácter publicitario, debiéndose utilizar en la instalación real las instrucciones de colocación de Cerámica Mayor.

Mayor
CERAMICA SINCE
FONDATARE 1888