

Mayor

LEADING
OUTDOOR
PROJECTS

The art of *living outdoors*

Catálogo / Catalogue 2026

Mayor

LEADING
OUTDOOR
PROJECTS

Índice | Index

por paginación | by pagination

04.

SOBRE NOSOTROS
ABOUT US

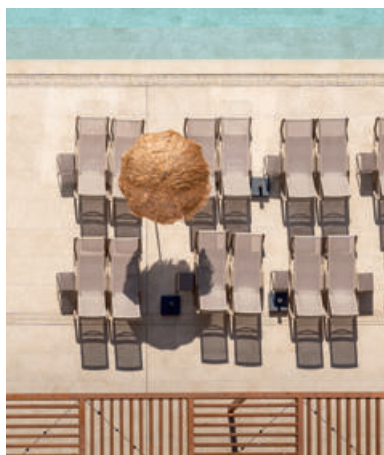

Lectura del catálogo
Reading the catalogue **06**

Nuestra esencia
Our essence **08**

ADN de marca
Brand DNA **10**

Simbología
Symbology **13**

14.

COLECCIONES
COLLECTIONS

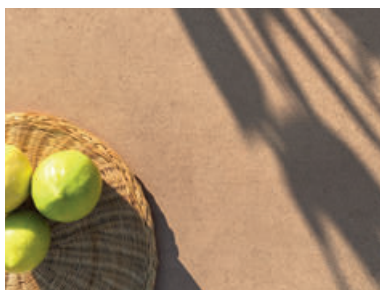

Crosscut **16**

Veincut **26**

Savoy **36**

Stromboli **46**

Cupira **56**

Salem **66**

Coralina **76**

Eterna **86**

Iconic **94**

Calacatta **102**

Cements **108**

Cotto **116**

Amazonia **122**

Mizu **130**

Tropic **138**

Bali **146**

Volcanic **154**

162.

PIEZAS ESPECIALES
SPECIAL PIECES



Peldaños | *Steps* **164**

Pavimento 20 mm | *20 mm Flg.* **166**

Bordes de piscina | *Pool Edges*

Creta **168**

Maui **170**

Samoa **172**

Aruba **174**

Rejillas de drenaje | *Drain grates*

RJ25 **176**

RJ25 FLEX **178**

RJ25 INV **180**

RJ20 **182**

RJ20 FLEX **184**

Sistema Block25 | *Block25 System* **186**

Piezas de terminación | *Trims* **190**

194.

SISTEMAS CONSTRUCTIVOS PISCINAS *POOL CONSTRUCTIVE SYSTEMS*



Desbordante
Overflowing **196**

Infinity
Infinity **198**

Skimmer
Skimmer **200**

Interior de la piscina
Inside the swimming pool **202**

204.

COLOCACIÓN *PLACEMENT*

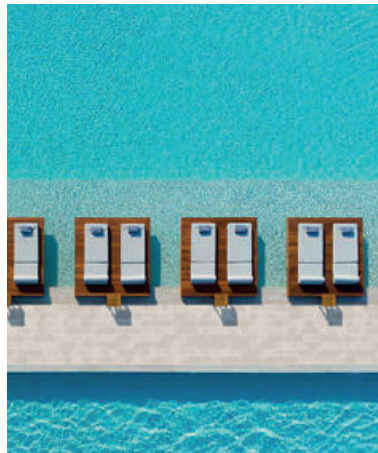

Pavimento
Flooring **206**

Colores junta recomendados
Recommended grout colours **210**

Pavimento 20 mm
20 mm Flooring **212**

Peldaños
Steps **216**

Piezas especiales | *Special pieces*

Bordes y rejillas
Edges and Drain grates **220**

Block25 **224**

226.

INFORMACIÓN DE EMBALAJE *PACKING INFORMATION*



Dimensiones de las piezas
Pieces dimensions **228**

Información técnica del pavimento
Technical information on flooring **229**

Ventajas del gres porcelánico
Porcelain stoneware advantages **230**

Resumen colecciones
Collections overview **231**

Información del embalaje
Packing data **232**

Resumen colores colecciones
Collections colours overview **236**

Indice | Index

por formatos | by formats

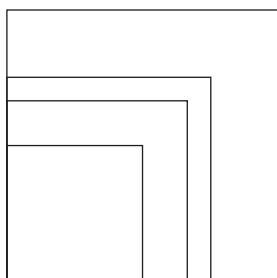

Formato cuadrado Square format

120 x 120 cm | 47.2" x 47.2"

Crosscut	16
Salem	66
Iconic	94

90 x 90 cm | 35.4" x 35.4"

Crosscut	16
Savoy	36
Salem	66
Coralina	76
Cements	108
Cotto	116

75 x 75 cm | 29.5" x 29.5"

Stromboli	46
-----------	----

60 x 60 cm | 23.6" x 23.6"

Crosscut	16
Stromboli	46
Salem	66
Coralina	76

90 x 90 x 2 cm | 35.4" x 35.4" x 0.78"

Savoy	36
Salem	66

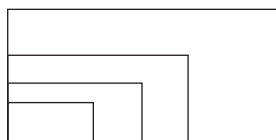

Formato Rectangular Rectangular format

60 x 120 cm | 23.6" x 47.2"

Crosscut	16
Veincut	26
Savoy	36
Stromboli	46
Cupira	56
Salem	66
Coralina	76
Eterna	86
Iconic	94
Calacatta	102
Cements	108

37,5 x 75 cm | 14.7" x 29.5"

Crosscut	16
Veincut	26
Stromboli	46
Cupira	56
Cements	108

30 x 60 cm | 11.8" x 23.6"

Bali	146
Volcanic	154

11,5 x 23 cm | 4.52" x 9.05"

Mizu	130
------	-----

60 x 120 x 2 cm | 23.6" x 47.2" x 0.78"

Crosscut	16
Stromboli	46

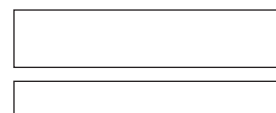

Formato Rectangular Rectangular format

20 x 120 cm | 7.8" x 47.2"

Amazonia	122
----------	-----

30 x 120 cm | 11.8" x 47.2"

Amazonia	122
----------	-----



Pequeño formato Small format

14,7 x 14,7 cm | 5.7" x 5.7"

Cupira	56
Tropic	138
Bali	146
Volcanic	154





Nombre de la colección
Name of the collection

Número de página
Page number

Descripción de la colección
Description of the collection

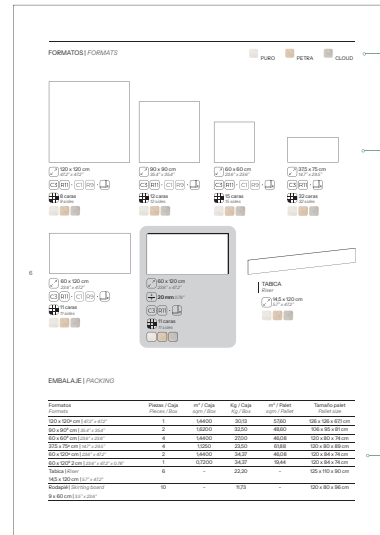

Colores colección
Collection colours

Formatos
Formats

Información embalaje
Packing information

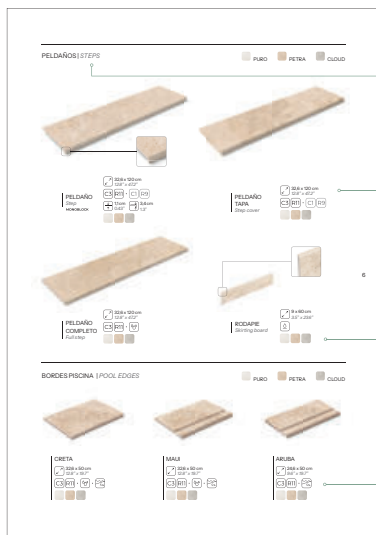

Tipo de producto
Product type

Tamaño
Size

Colores disponibles
Available colours

Características producto
Product features

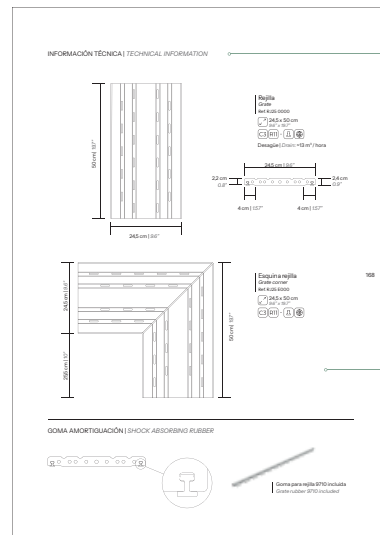

Características técnicas
Technical information

Dimensiones de la pieza especial
Dimensions of the special piece



SAVOY DESERT



«El Mediterráneo no es un lugar.
Es una forma de hacer las cosas».

—

«*The Mediterranean is not a place.
It is a way of doing things*».



Nuestra esencia | Our essence

«La técnica se aprende. El alma se hereda».

—

«*Technique can be learned. The soul is inherited.*».

Somos inconformistas, coherentes y cercanos.

Diseñamos con exigencia, fabricamos con cuidado y acompañamos a cada cliente con la cercanía de quien entiende su oficio.

—

We are non-conformists, consistent and approachable.

We design with high standards, manufacture with care, and support each customer with the intimacy of someone who understands their trade.

ADN de marca | Brand DNA

«Nuestro ADN está formado por seis principios que definen como pensamos y trabajamos».

—
«Our DNA is made up of six principles that define how we think and work».

Exigencia | High standards

Hacemos las cosas bien. Y cuando están bien, las mejoramos.

We do things right. And when they're right, we make them even better.

Cuidado | Care

Prestamos atención a lo que importa: las personas, los detalles y los procesos.

We pay attention to what matters: people, details and processes.

Innovación | Innovation

Convertimos la técnica en experiencia.

We turn technique into experience.

Diseño | Design

La belleza funcional es nuestro lenguaje.

Functional beauty is our language.

Compromiso | Commitment

Acompañamos cada proyecto antes, durante y después.

We support each project before, during and after.

Visión | Vision

Más de un siglo diseñando con propósito.

Nuestra historia no se repite: se proyecta.

Over a century of purposeful design.

We do not repeat our history; we project it.

«La técnica está al servicio de la emoción.
La emoción está al servicio del diseño».

—
*«Technique is at the service of emotion.
Emotion is at the service of design».*





CORALINA AGUADA

Simbología | Symbology



Número de caras
Number of sides

Hemos incorporado un nuevo icono que te permite identificar fácilmente cuántas caras de diseño diferentes existen en cada formato.
We have added a new icon that allows you to easily identify how many different design faces there are in each format.



Tamaño de la base
Tile size

60 x 120 cm | 23.6" x 47.2"

Unidades de medida
Units of measurement

MONOBLOCK

Fabricado de una pieza, sin pegado
Made in one piece, not glued



Piezas y bases de exterior Clase 3
Outdoor pieces and tiles Class 3



Piezas y bases de interior Clase 1
Indoor pieces and tiles Class 1



Piezas y bases de exterior R11
Outdoor pieces and tiles R11



Piezas y bases de interior R9
Indoor pieces and tiles R9



Bases rectificadas
Rectified tiles



Grosor de la base
Tile thickness



Producto de fácil limpieza
Easy clean product



Sistema flexible
Flexible system



Patente mundial de la pieza
Worldwide patent of the piece



Durabilidad
Durability



Sistema con goma de amortiguación
Rubber cushioning system



Esmaltado superior
Fully Glazed



Antideslizante Clase 1 | Clase 3
Non-slip Class 1 | Class 3



Esmaltado a 3 caras
Enamelled on 3 sides



Grosor lateral peldaño
Step side thickness



EN 16165 | R11 Clase C
EN 16165 | R11 Class C



Inclinación suelo. Sist. Desbordante
Floor inclination. Overflow system.



Inclinación pieza. Sist. Desbordante
Piece inclination. Overflow system.



Antideslizamiento. Ensayo Péndulo
Anti-slip. Pendulum test



Resistencia al Hielo
Freeze Resistance



Resistencia Química
Chemical Resistance

EN 16165 Clase 3

EN ISO 10545-12

EN ISO 10545-13 GA / GLA / GHA

COLECCIONES

Collections

Colecciones
Collections

Piezas especiales
Special pieces

Sistemas constructivos piscinas
Pool construction systems

Colocación pavimento
Flooring installation

Colocación peldaños
Steps installation

Colocación piezas
especiales piscinas
*Installation of special
pool components*

«Creamos y diseñamos colecciones
atemporales que convierten cada
exterior en un lugar para disfrutar».

*«We create and design timeless collections
that turn every outdoor space
into a place to enjoy».*



CROSSCUT PURO

CROSSCUT

«De la esencia del Travertino nace Crosscut, el corte transversal que reinventa la estética de esta piedra clásica italiana».

—
«Crosscut is born from the essence of Travertine, the cross-cut that reinvents the aesthetics of this classic Italian stone».



17

Inspirada en el Travertino, piedra emblemática de la arquitectura clásica italiana, de tono beige claro. Su nombre, Crosscut, honra el corte transversal dado a los bloques originales de la piedra, resaltando su apariencia habitual.

—
Inspired by Travertine, an emblematic stone of classic Italian architecture, in a light beige tone. Its name, Crosscut, honours the transversal cut given to the original blocks of the stone, revealing its usual appearance.



CROSSCUT PURO



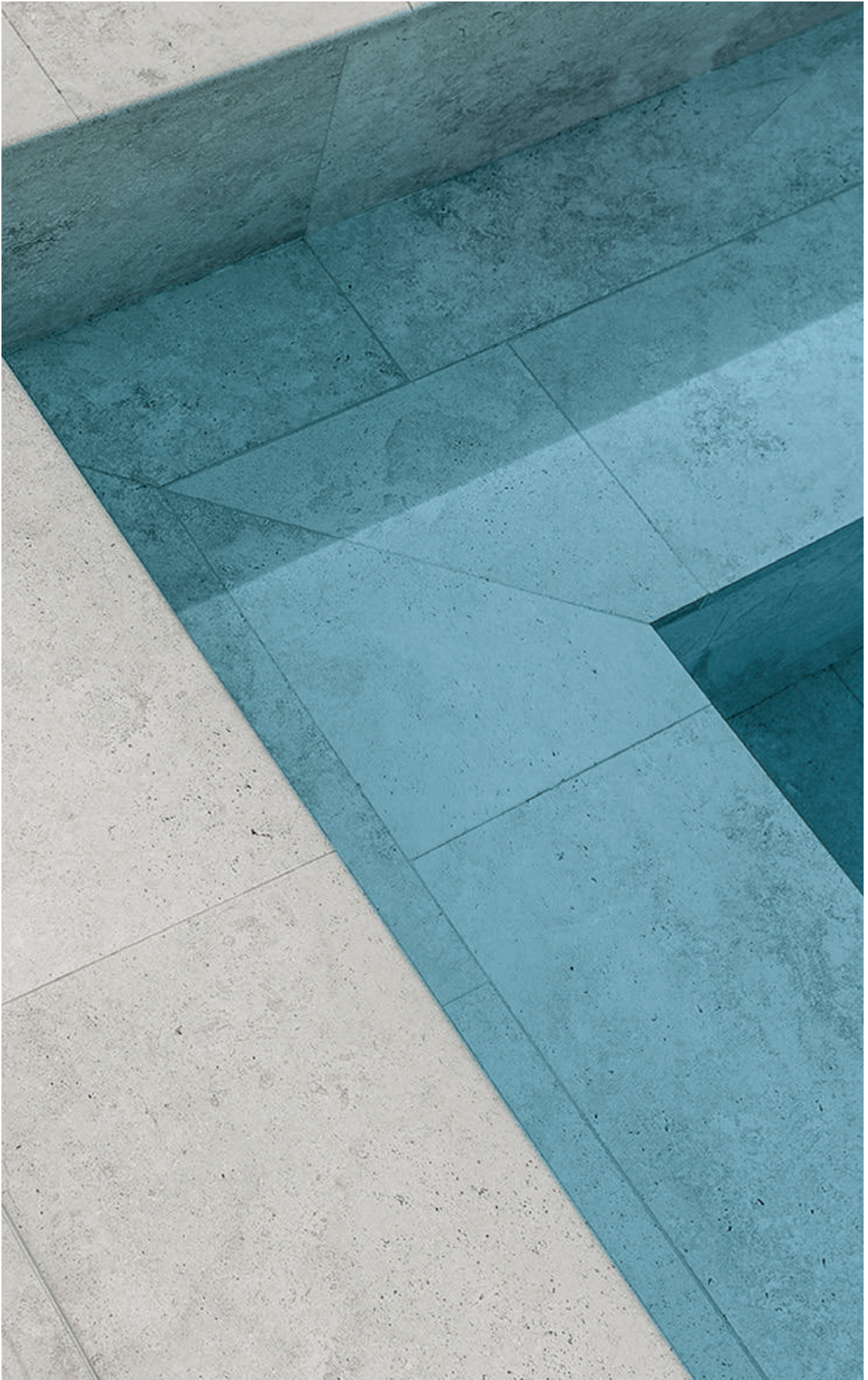

CROSSCUT **CLOUD**



CROSSCUT **PURO**



CROSSCUT **PETRA**



CROSSCUT **CLOUD**

FORMATOS | FORMATS

PURO (PR)
 PETRA (PT)
 CLOUD (CL)

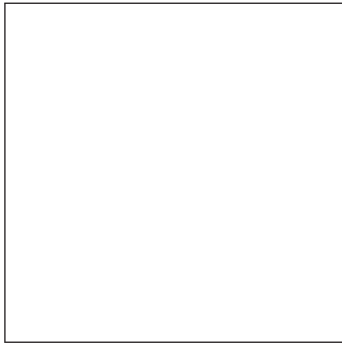

120 x 120 cm
 47.2" x 47.2"
 C3 R11 · C1 R9 ·
 8 caras
 8 sides
 PR PT CL

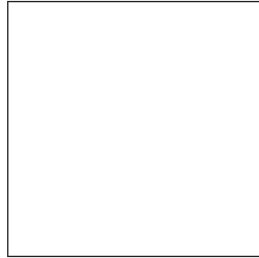

90 x 90 cm
 35.4" x 35.4"
 C3 R11 · C1 R9 ·
 12 caras
 12 sides
 PR PT CL

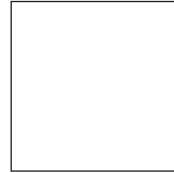

60 x 60 cm
 23.6" x 23.6"
 C3 R11 · C1 R9 ·
 15 caras
 15 sides
 PR PT CL



37,5 x 75 cm
 14.7" x 29.5"
 C3 R11 ·
 32 caras
 32 sides
 PR PT CL

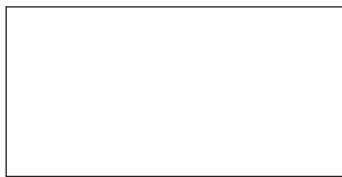

60 x 120 cm
 23.6" x 47.2"
 C3 R11 · C1 R9 ·
 11 caras
 11 sides
 PR PT CL

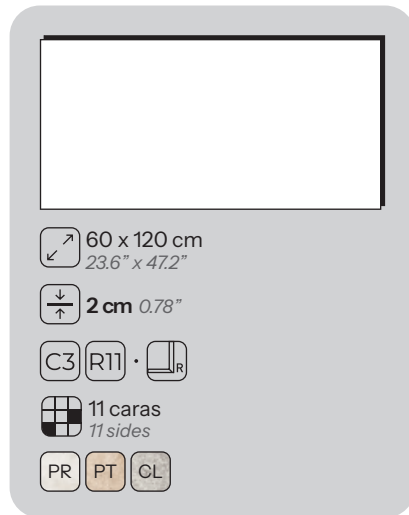

60 x 120 cm
 23.6" x 47.2"
 2 cm 0.78"
 C3 R11 ·
 11 caras
 11 sides
 PR PT CL



TABICA
 Riser
 14,5 x 120 cm
 5.7" x 47.2"
 PR PT CL

22

EMBALAJE | PACKING

Formatos Formats	Piezas / Caja Pieces / Box	m ² / Caja sqm / Box	Kg / Caja Kg / Box	m ² / Palet sqm / Pallet	Tamaño palet Pallet size
120 x 120 ^R cm 47.2" x 47.2"	1	1,4400	30,13	57,60	126 x 126 x 67,1 cm
90 x 90 ^R cm 35.4" x 35.4"	2	1,6200	32,50	48,60	106 x 95 x 81 cm
60 x 60 ^R cm 23.6" x 23.6"	4	1,4400	27,00	46,08	120 x 80 x 74 cm
37.5 x 75 ^R cm 14.7" x 29.5"	4	1,1250	23,50	61,88	120 x 80 x 89 cm
60 x 120 ^R cm 23.6" x 47.2"	2	1,4400	34,37	46,08	120 x 84 x 74 cm
60 x 120 ^R 2 cm 23.6" x 47.2" x 0.78"	1	0,7200	34,37	19,44	120 x 84 x 74 cm
Tabica Riser	6	-	22,20	-	125 x 110 x 90 cm
14,5 x 120 cm 5.7" x 47.2"					
Rodapié Skirting board	10	-	11,73	-	120 x 80 x 96 cm
9 x 60 cm 3.5" x 23.6"					

PELDAÑOS | STEPS

PURO (PR) PETRA (PT) CLOUD (CL)

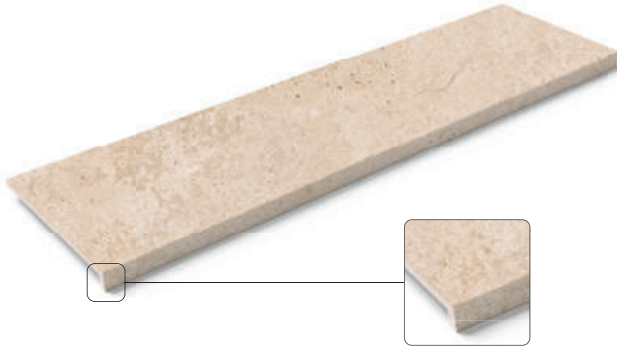

PELDAÑO
Step
MONOBLOCK

32,6 x 120 cm
12.8" x 47.2"

C3 R11 · C1 R9

1,1 cm
0.43" 3,4 cm
1.3"

PR PT CL



PELDAÑO
TAPA
Step cover

32,6 x 120 cm
12.8" x 47.2"

C3 R11 · C1 R9

PR PT CL



PELDAÑO
COMPLETO
Full step

32,6 x 120 cm
12.8" x 47.2"

C3 R11 · 0°

PR PT CL



RODAPIE
Skirting board

9 x 60 cm
3.5" x 23.6"

PR PT CL

23

BORDES PISCINA | POOL EDGES

PURO (PR) PETRA (PT) CLOUD (CL)



CRETA

32,6 x 50 cm
12.8" x 19.7"

C3 R11 · 0° · 5%

PR PT CL



MAUI

32,6 x 50 cm
12.8" x 19.7"

C3 R11 · 0° · 5%

PR PT CL



ARUBA

24,6 x 50 cm
9.6" x 19.7"

C3 R11 · 5%

PR PT CL

BORDES PISCINA | POOL EDGES

PURO (PR)
 PETRA (PT)
 CLOUD (CL)



SAMOA

↗ 50 x 120 cm
↙ 19.7" x 47.6"

C3 R11 · ☼

PR
 PT
 CL

REJILLAS DE DRENAJE | DRAIN GRATES

PURO (PR)
 PETRA (PT)
 CLOUD (CL)

24



RJ20

Desagüe | Drain > 11 m³ / h

↗ 19,3 x 50 cm
↙ 7.6" x 19.7"

C3 R11 · I G

PR
 PT
 CL

Goma para rejilla 9710 incluida
Grate rubber 9710 included



RJ20 FLEX

Desagüe | Drain > 30 m³ / h

↗ 19,3 x 50 cm
↙ 7.6" x 19.7"

C3 R11 · I S G

PR
 PT
 CL

Goma para rejilla 9134 incluida
Grate rubber 9134 included



RJ25

Desagüe | Drain > 13 m³

↗ 24,5 x 50 cm
↙ 9.6" x 19.7"

C3 R11 · I G

PR
 PT
 CL

Goma para rejilla 9710 incluida
Grate rubber 9710 included



RJ25 FLEX

Desagüe | Drain > 30 m³ / h

↗ 24,5 x 50 cm
↙ 9.6" x 19.7"

C3 R11 · I S G

PR
 PT
 CL

Goma para rejilla 9134 incluida
Grate rubber 9134 included



RJ25 INV

Desagüe | Drain > 8 m³ / h

↗ 24,5 x 50 cm
↙ 9.6" x 19.7"

C3 R11 · I G ☼

PR
 PT
 CL

Goma para rejilla 12719 incluida
Grate rubber 12719 included







Media caña exterior

Outer trims

Ref. MDCA E000

 4,5 x 50 cm
1.8" x 19.7"

  ·   







Escocia cantonera ext.

Covemolding outer corner

Ref. MDCA EE00

 4,5 x 4,5 cm
1.8" x 1.8"

  ·   







Esquina cantonera ext.

Outer angle corner

Ref. MDCA AE00

 6,5 x 6,5 cm
2.6" x 2.6"

  ·   







Media caña interior

Inner trims

Ref. MDCA I000

 5,5 x 50 cm
2.2" x 19.7"

  ·   







Escocia cantonera int.

Covemolding inner corner

Ref. MDCA EI00

 5,5 x 5,5 cm
2.2" x 2.2"

  ·   



Esquina cantonera int.

Inner angle corner

Ref. MDCA AI00

 6,5 x 6,5 cm
2.6" x 2.6"

  ·   







Cantonera transición ext.

External transition corner

Ref. MDCA CE00

 4,5 x 25 cm
1.8" x 9.8"

  ·   







Cantonera transición int.

Inner transition corner

Ref. MDCA CI00

 5,5 x 25 cm
2.2" x 9.8"

  ·   

*Información detallada sobre las piezas de terminación en las páginas 190 y 191.

*Detailed information about trims pieces in pages 190 and 191.



VEINCUT SAHARA

VEINCUT

«Las vetas longitudinales se resaltan de manera precisa, logrando un diseño fluido y uniforme».

—
«*The longitudinal veins are precisely highlighted, achieving a fluid and uniform design.*».

nuevo
new



VEINCUT SAHARA

27

Formada en depósitos de aguas termales, ríos y manantiales ricos en carbonato de calcio, esta piedra icónica se distingue por sus vetas lineales y su textura única, testimonio de miles de años de historia geológica. A través del exclusivo corte Vein Cut, las vetas longitudinales se resaltan de manera precisa, logrando un diseño fluido y uniforme que aporta movimiento y sofisticación.

—
Formed in calcium carbonate-rich hot, rivers and springs, this iconic stone is distinguished by its linear veins and unique texture, a testament to thousands of years of geological history. Through the exclusive Vein Cut, the longitudinal veins are precisely highlighted, achieving a fluid and uniform design that brings movement and sophistication.



VEINCUT **AURORA**





VEINCUT **BASALT**



VEINCUT **AURORA**



VEINCUT **SAHARA**



VEINCUT **BASALT**

FORMATOS | FORMATS

 AURORA (AU)

 SAHARA (SH)

 BASALT (BS)

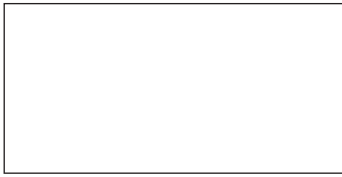

 60 x 120 cm
23.6" x 47.2"

C3 R11 · C1 R9 · 

 16 caras
16 sides



  



 37,5 x 75 cm
14.7" x 29.5"

C3 R11 · 

 32 caras
32 sides



TABICA

Riser

 14,5 x 120 cm
5.7" x 47.2"

EMBALAJE | PACKING

Formatos Formats	Piezas / Caja Pieces / Box	m ² / Caja sqm / Box	Kg / Caja Kg / Box	m ² / Palet sqm / Pallet	Tamaño palet Pallet size
60 x 120 ^R cm 23.6" x 47.2"	2	1,4400	34,37	46,08	120 x 84 x 74 cm
37,5 x 75 ^R cm 14.7" x 29.5"	4	1,1250	23,50	61,88	120 x 80 x 89 cm
Tabica Riser 14,5 x 120 cm 5.7" x 47.2"	6	-	22,20	-	125 x 110 x 90 cm
Rodapié Skirting board 9 x 60 cm 3.5" x 23.6"	10	-	11,73	-	120 x 80 x 96 cm

32

PELDAÑOS | STEPS

 AURORA (AU)

 SAHARA (SH)

 BASALT (BS)

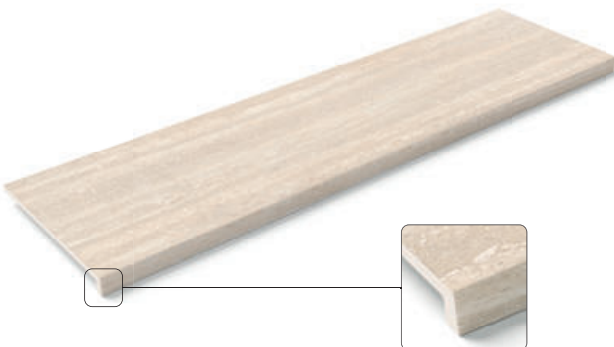



PELDAÑO
Step
MONOBLOCK

 32,6 x 120 cm
12.8" x 47.2"

C3 R11 · C1 R9

 1,1 cm
0.43"  3,4 cm
1.3"



  



PELDAÑO
TAPA
Step cover

 32,6 x 120 cm
12.8" x 47.2"

C3 R11 · C1 R9

PELDAÑOS | STEPS

AURORA (AU)

SAHARA (SH)

BASALT (BS)



RODAPIE
Skirting board

9 x 60 cm
3.5" x 23.6"



AU SH BS

BORDES PISCINA | POOL EDGES

AURORA (AU)

SAHARA (SH)

BASALT (BS)



CRETA

32,6 x 50 cm
12.8" x 19.7"



AU SH BS

MAUI

32,6 x 50 cm
12.8" x 19.7"



AU SH BS

33

REJILLAS DE DRENAJE | DRAIN GRATES

AURORA (AU)

SAHARA (SH)

BASALT (BS)



RJ25

Desagüe | Drain > 13 m³

24,5 x 50 cm
9.6" x 19.7"



AU SH BS

Goma para rejilla 9710 incluida
Grate rubber 9710 included

RJ25 FLEX

Desagüe | Drain > 30 m³ / h

24,5 x 50 cm
9.6" x 19.7"



AU SH BS

Goma para rejilla 9134 incluida
Grate rubber 9134 included

RJ25 INV

Desagüe | Drain > 8 m³ / h

24,5 x 50 cm
9.6" x 19.7"



AU SH BS

Goma para rejilla 12719 incluida
Grate rubber 12719 included



Media caña exterior

Outer trims

Ref. MDCA E000

 4,5 x 50 cm
1.8" x 19.7"

  • AU SH BS





Escocia cantonera ext.

Covemolding outer corner

Ref. MDCA EE00

 4,5 x 4,5 cm
1.8" x 1.8"

  • AU SH BS



Esquina cantonera ext.

Outer angle corner

Ref. MDCA AE00

 6,5 x 6,5 cm
2.6" x 2.6"

  • AU SH BS





Media caña interior

Inner trims

Ref. MDCA I000

 5,5 x 50 cm
2.2" x 19.7"

  • AU SH BS





Escocia cantonera int.

Covemolding inner corner

Ref. MDCA EI00

 5,5 x 5,5 cm
2.2" x 2.2"

  • AU SH BS





Esquina cantonera int.

Inner angle corner

Ref. MDCA AI00

 6,5 x 6,5 cm
2.6" x 2.6"

  • AU SH BS

34





Cantonera transición ext.

External transition corner

Ref. MDCA CE00

 4,5 x 25 cm
1.8" x 9.8"

  • AU SH BS

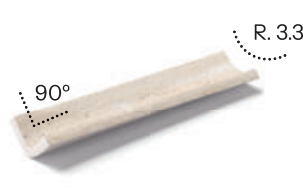



Cantonera transición int.

Inner transition corner

Ref. MDCA CI00

 5,5 x 25 cm
2.2" x 9.8"

  • AU SH BS

*Información detallada sobre las piezas de terminación en las páginas 190 y 191.

*Detailed information about trims pieces in pages 190 and 191.





SAVOY DESERT

SAVOY

«El Grigio Venato, con sus delicados contrastes, refleja la fuerza de la naturaleza y se convierte en una propuesta versátil y de alta calidad, capaz de integrarse en diversos estilos decorativos».

—
«Grigio Venato, with its delicate contrasts, reflects the power of nature and becomes a versatile, high-quality option that can be integrated into a variety of decorative styles».



37

Interpretación de la piedra Grigio Venato, nacida a los pies de los Alpes. Las sutiles transiciones entre zonas veteadas y fondo aportan dinamismo. Una propuesta de alta calidad que se adapta a la perfección a cualquier estilo decorativo.

—
An interpretation of the Grigio Venato stone, born at the foot of the Alps. The subtle transitions between the veined areas and the background bring dynamism. A high quality proposal that adapts perfectly to any decorative style.







SAVOY LAND



SAVOY **MOON**



SAVOY **DESERT**



SAVOY **LAND**

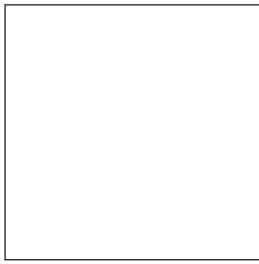

↖ ↗ 90 x 90 cm
35.4" x 35.4"

C3 R11 · C1 R9 ·

30 caras
30 sides

MN DS LN

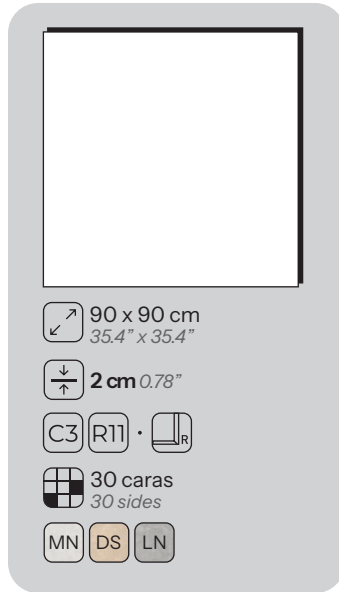

↖ ↗ 90 x 90 cm
35.4" x 35.4"

↓ ↑ 2 cm 0.78"

C3 R11 ·

30 caras
30 sides

MN DS LN



↖ ↗ 60 x 120 cm
23.6" x 47.2"

C3 R11 · C1 R9 ·

16 caras
16 sides

MN DS LN



↖ ↗ 37,5 x 75 cm
14.7" x 29.5"

C3 R11 ·

30 caras
30 sides

MN DS LN



TABICA
Riser

↖ ↗ 14,5 x 120 cm
5.7" x 47.2"

MN DS LN

42

EMBALAJE | PACKING

Formatos Formats	Piezas / Caja Pieces / Box	m ² / Caja sqm / Box	Kg / Caja Kg / Box	m ² / Palet sqm / Pallet	Tamaño palet Pallet size
90 x 90 ^R cm 35.4" x 35.4"	2	1,6200	32,50	48,60	106 x 95 x 81 cm
90 x 90 ^R 2 cm 35.4" x 35.4" x 0.78"	1	0,8100	40,00	21,87	97 x 97 x 85 cm
60 x 120 ^R cm 23.6" x 47.2"	2	1,4400	34,37	46,08	120 x 84 x 74 cm
37,5 x 75 ^R cm 14.7" x 29.5"	4	1,1250	23,50	61,88	120 x 80 x 89 cm
Tabica Riser	6	-	22,20	-	125 x 110 x 90 cm
14,5 x 120 cm 5.7" x 47.2"					
Rodapié Skirting board	10	-	11,73	-	120 x 80 x 96 cm
9 x 60 cm 3.5" x 23.6"					

PELDAÑOS | STEPS

MOON (MN) DESERT (DS) LAND (LN)

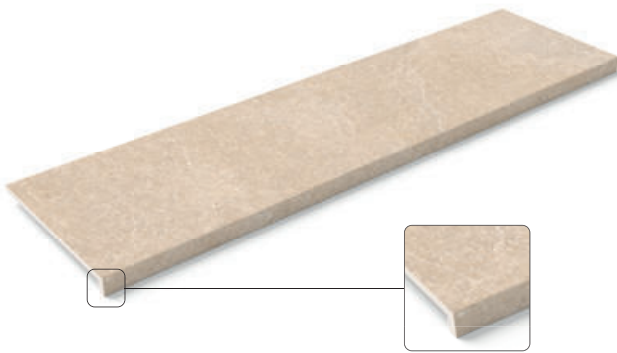

PELDAÑO
Step
MONOBLOCK

32,6 x 120 cm
12,8" x 47,2"

C3 R11 · C1 R9

1,1 cm 0,43" 3,4 cm 1,3"

MN DS LN

PELDAÑO
TAPA
Step cover

32,6 x 120 cm
12,8" x 47,2"

C3 R11 · C1 R9

MN DS LN



RODAPIE
Skirting board

9 x 60 cm
3,5" x 23,6"

MN DS LN

43

BORDES PISCINA | POOL EDGES

MOON (MN) DESERT (DS) LAND (LN)



CRETA

32,6 x 50 cm
12,8" x 19,7"

C3 R11 · 0° · 5%

MN DS LN

MAUI

32,6 x 50 cm
12,8" x 19,7"

C3 R11 · 0° · 5%

MN DS LN

BORDES PISCINA | POOL EDGES

MOON (MN) DESERT (DS) LAND (LN)



SAMOA

50 x 120 cm
19.7" x 47.6"

C3 R11

MN DS LN

REJILLAS DE DRENAJE | DRAIN GRATES

MOON (MN) DESERT (DS) LAND (LN)



RJ25

Desagüe | Drain > 13 m³

24,5 x 50 cm
9.6" x 19.7"

C3 R11

MN DS LN

Goma para rejilla 9710 incluida
Grate rubber 9710 included

RJ25 FLEX

Desagüe | Drain > 30 m³ / h

24,5 x 50 cm
9.6" x 19.7"

C3 R11

MN DS LN

Goma para rejilla 9134 incluida
Grate rubber 9134 included

RJ25 INV

Desagüe | Drain > 8 m³ / h

24,5 x 50 cm
9.6" x 19.7"

C3 R11

MN DS LN

Goma para rejilla 12719 incluida
Grate rubber 12719 included



Media caña exterior

Outer trims

Ref. MDCA E000

↖ ↗ 4,5 x 50 cm
1.8" x 19.7"

C3 R11 · MN DS LN



Escocia cantonera ext.

Covemolding outer corner

Ref. MDCA EE00

↖ ↗ 4,5 x 4,5 cm
1.8" x 1.8"

C3 R11 · MN DS LN



Esquina cantonera ext.

Outer angle corner

Ref. MDCA AE00

↖ ↗ 6,5 x 6,5 cm
2.6" x 2.6"

C3 R11 · MN DS LN



Media caña interior

Inner trims

Ref. MDCA I000

↖ ↗ 5,5 x 50 cm
2.2" x 19.7"

C3 R11 · MN DS LN



Escocia cantonera int.

Covemolding inner corner

Ref. MDCA EI00

↖ ↗ 5,5 x 5,5 cm
2.2" x 2.2"

C3 R11 · MN DS LN



Esquina cantonera int.

Inner angle corner

Ref. MDCA AI00

↖ ↗ 6,5 x 6,5 cm
2.6" x 2.6"

C3 R11 · MN DS LN



Cantonera transición ext.

External transition corner

Ref. MDCA CE00

↖ ↗ 4,5 x 25 cm
1.8" x 9.8"

C3 R11 · MN DS LN



Cantonera transición int.

Inner transition corner

Ref. MDCA CI00

↖ ↗ 5,5 x 25 cm
2.2" x 9.8"

C3 R11 · MN DS LN

*Información detallada sobre las piezas de terminación en las páginas 190 y 191.

*Detailed information about trims pieces in pages 190 and 191.



STROMBOLI CREAM

STROMBOLI

«Inspirada en la piedra caliza, combina un fondo uniforme con incrustaciones que aportan movimiento y un equilibrio entre sobriedad y vitalidad».

—
«Inspired by limestone, it combines a uniform background with inlays that add movement and a balance between sobriety and vitality».



47

Inspirada en la piedra caliza, su fondo regular se combina con incrustaciones de piedras más pequeñas, simulando un flujo visual que agrega movimiento. Una perfecta gama armoniosa que fusiona la sobriedad y la vitalidad.

—
Inspired by limestone, its regular background is combined with inlays of smaller stones, simulating a visual flow that adds movement. A perfect harmonious range that fuses the sobriety and the vitality.



STROMBOLI **LIGHT**



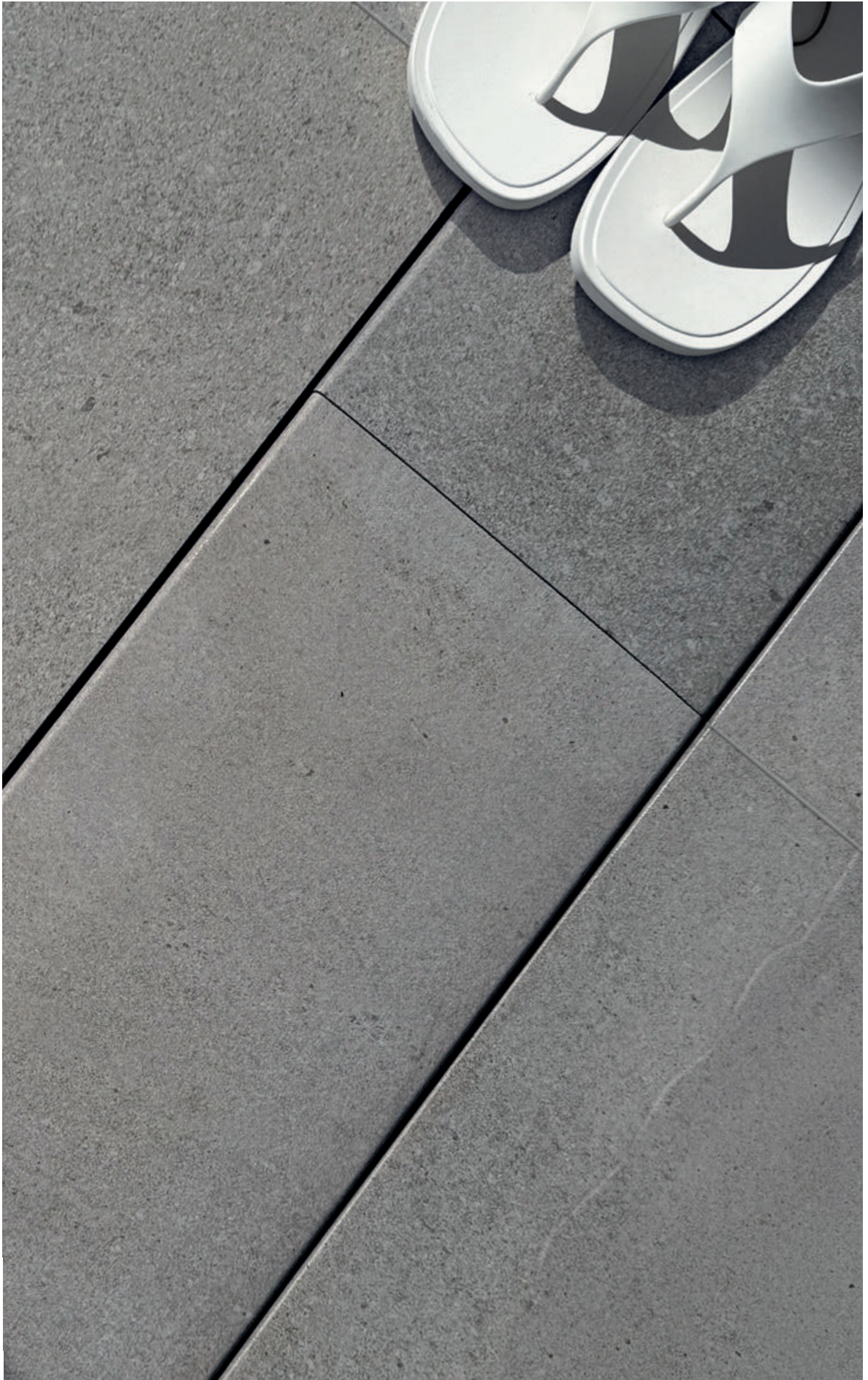

STROMBOLI **SILVER**



STROMBOLI **LIGHT**



STROMBOLI **CREAM**





STROMBOLI **SILVER**

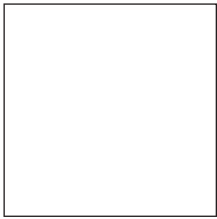

FORMATOS | FORMATS

 LIGHT (LG)  CREAM (CR)  SILVER (SL)



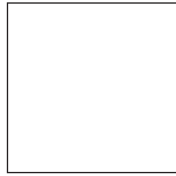

 75 x 75 cm
29.5" x 29.5"
C3 R11 · C1 R9 · 
 12 caras
12 sides
LG CR SL









 60 x 60 cm
23.6" x 23.6"
C3 R11 · 
 24 caras
24 sides
LG CR SL



 60 x 120 cm
23.6" x 47.2"
C3 R11 · C1 R9 · 
 12 caras
12 sides
LG CR SL



 37,5 x 75 cm
14.7" x 29.5"
C3 R11 · 
 24 caras
24 sides
LG CR SL

 60 x 120 cm
23.6" x 47.2"
 2 cm 0.78"
C3 R11 · 
 12 caras
12 sides
LG



TABICA
Riser
 14,5 x 120 cm
5.7" x 47.2"
LG CR SL

52

EMBALAJE | PACKING

Formatos Formats	Piezas / Caja Pieces / Box	m ² / Caja sqm / Box	Kg / Caja Kg / Box	m ² / Palet sqm / Pallet	Tamaño palet Pallet size
75 x 75 ^R cm 29.5" x 29.5"	2	1,1250	23,50	54,00	120 x 80 x 90 cm
60 x 60 ^R cm 23.6" x 23.6"	4	1,4400	27,00	46,08	120 x 80 x 74 cm
60 x 120 ^R cm 23.6" x 47.2"	2	1,4400	34,37	46,08	120 x 84 x 74 cm
37,5 x 75 ^R cm 14.7" x 29.5"	4	1,1250	23,50	61,88	120 x 80 x 89 cm
60 x 120 ^R 2 cm 23.6" x 47.2" x 0.78"	1	0,7200	34,37	19,44	120 x 84 x 74 cm
Tabica Riser	6	-	22,20	-	125 x 110 x 90 cm
14,5 x 120 cm 5.7" x 47.2"					
Rodapié Skirting board	10	-	11,73	-	120 x 80 x 96 cm
9 x 60 cm 3.5" x 23.6"					

PELDAÑOS | STEPS

LIGHT (LG) CREAM (CR) SILVER (SL)

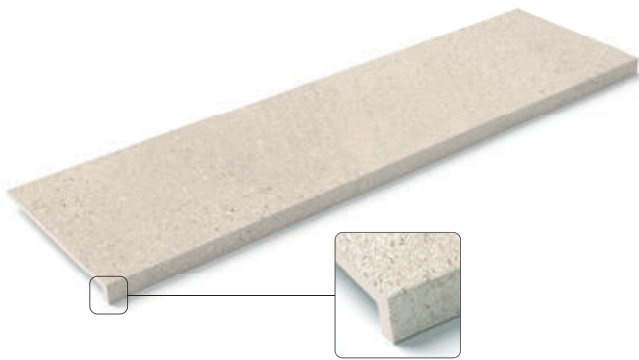

PELDAÑO
Step
MONOBLOCK

32,6 x 120 cm
12.8" x 47.2"

C3 R11 · C1 R9

11 cm
0.43"

3,4 cm
1.3"

LG CR SL

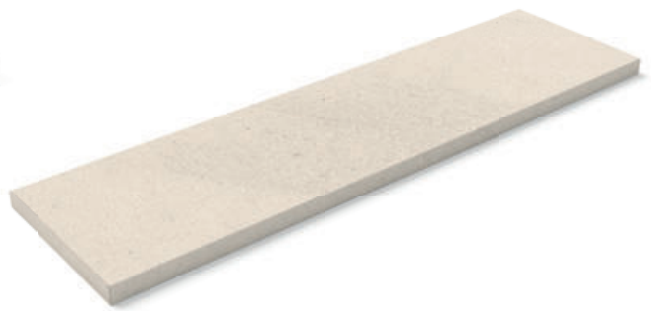

PELDAÑO
TAPA
Step cover

32,6 x 120 cm
12.8" x 47.2"

C3 R11 · C1 R9

LG CR SL

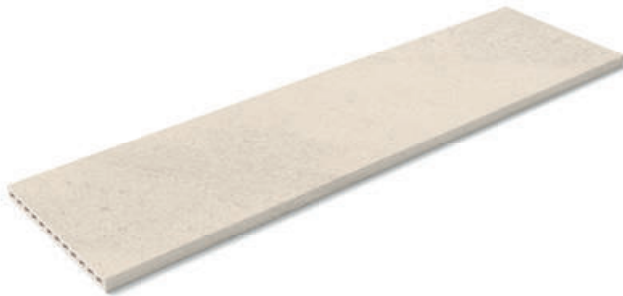

PELDAÑO
COMPLETO
Full step

32,6 x 120 cm
12.8" x 47.2"

C3 R11 · 0°

LG CR SL



RODAPIE
Skirting board

9 x 60 cm
3.5" x 23.6"

LG CR SL

BORDES PISCINA | POOL EDGES

LIGHT (LG) CREAM (CR) SILVER (SL)



CRETA

32,6 x 50 cm
12.8" x 19.7"

C3 R11 · 0° · 5%

LG CR SL



MAUI

32,6 x 50 cm
12.8" x 19.7"

C3 R11 · 0° · 5%

LG CR SL



ARUBA

24,6 x 50 cm
9.6" x 19.7"

C3 R11 · 5%







LG CR SL

BORDES PISCINA | POOL EDGES

 LIGHT (LG)  CREAM (CR)  SILVER (SL)



SAMOA

 50 x 120 cm
19.7" x 47.6"
  
 

REJILLAS DE DRENAJE | DRAIN GRATES

 LIGHT (LG)  CREAM (CR)  SILVER (SL)

54



RJ20

Desagüe | Drain > 11 m³ / h

 19,3 x 50 cm
7.6" x 19.7"
   
  

Goma para rejilla 9710 incluida
Grate rubber 9710 included



RJ20 FLEX

Desagüe | Drain > 30 m³ / h







 19,3 x 50 cm
7.6" x 19.7"
    
  

Goma para rejilla 9134 incluida
Grate rubber 9134 included



RJ25

Desagüe | Drain > 13 m³

 24,5 x 50 cm
9.6" x 19.7"
   
  

Goma para rejilla 9710 incluida
Grate rubber 9710 included



RJ25 FLEX

Desagüe | Drain > 30 m³ / h

 24,5 x 50 cm
9.6" x 19.7"
    
  

Goma para rejilla 9134 incluida
Grate rubber 9134 included



RJ25 INV

Desagüe | Drain > 8 m³ / h

 24,5 x 50 cm
9.6" x 19.7"
    
  

Goma para rejilla 12719 incluida
Grate rubber 12719 included



Media caña exterior

Outer trims

Ref. MDCA E000

↗ 4,5 x 50 cm
↖ 1.8" x 19.7"

C3 R11 · LG CR SL



Escocia cantonera ext.

Covemolding outer corner

Ref. MDCA EE00

↗ 4,5 x 4,5 cm
↖ 1.8" x 1.8"

C3 R11 · LG CR SL



Esquina cantonera ext.

Outer angle corner

Ref. MDCA AE00

↗ 6,5 x 6,5 cm
↖ 2.6" x 2.6"

C3 R11 · LG CR SL



Media caña interior

Inner trims

Ref. MDCA I000

↗ 5,5 x 50 cm
↖ 2.2" x 19.7"

C3 R11 · LG CR SL



Escocia cantonera int.

Covemolding inner corner

Ref. MDCA EI00

↗ 5,5 x 5,5 cm
↖ 2.2" x 2.2"

C3 R11 · LG CR SL



Esquina cantonera int.

Inner angle corner

Ref. MDCA AI00

↗ 6,5 x 6,5 cm
↖ 2.6" x 2.6"

C3 R11 · LG CR SL

55



Cantonera transición ext.

External transition corner

Ref. MDCA CE00

↗ 4,5 x 25 cm
↖ 1.8" x 9.8"

C3 R11 · LG CR SL



Cantonera transición int.

Inner transition corner

Ref. MDCA CI00

↗ 5,5 x 25 cm
↖ 2.2" x 9.8"

C3 R11 · LG CR SL

*Información detallada sobre las piezas de terminación en las páginas 190 y 191.

*Detailed information about trims pieces in pages 190 and 191.



CUPIRA MULTI

CUPIRA

«Originaria de América del Norte, esta pizarra natural ofrece una rica variedad de tonalidades, donde cada laja única se une en un equilibrio de contrastes que realza su carácter y fuerza visual».

«Native to North America, this natural slate offers a rich variety of shades, where each unique slab comes together in a balance of contrasts that enhances its character and visual strength».



57

Pizarra natural procedente de América del Norte de la que obtenemos una amplia gama de tonalidades, haciendo que cada pieza sea única y atractiva. Cada laja es seleccionada para lograr un conjunto equilibrado de contrastes que dota a la colección de gran personalidad e impacto visual.

A natural slate from North America, we obtain a wide range of shades, making each piece unique and attractive. Each slab is selected to achieve a balanced set of contrasts that gives the collection great personality and visual impact.



CUPIRA **HUESO**





CUPIRA **MULTI**



CUPIRA **HUESO**



CUPIRA **MARENGO**

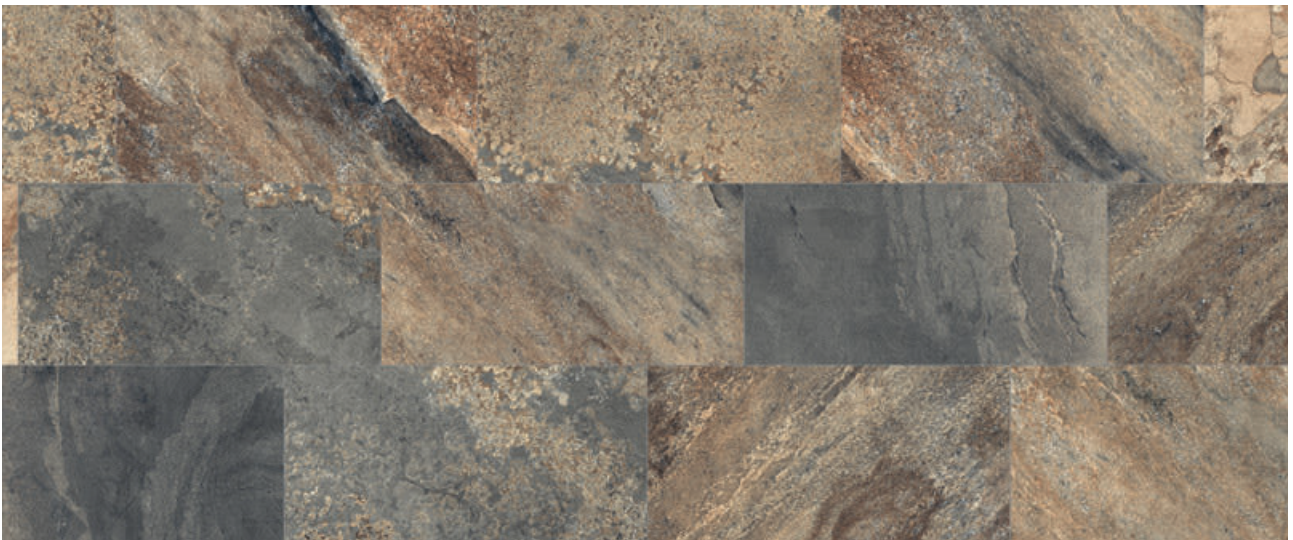

CUPIRA **MULTI**



60 x 120 cm
 23.6" x 47.2"

C3
R11 ·
 C1
R9 ·
 ·
 HS

C3
R11 ·
 ·
 MR

12 caras
 12 sides



37,5 x 75 cm
 14.7" x 29.5"

C3
R11 ·

HS
MR
ML

26 caras
 26 sides



14,7 x 14,7 cm
 5.7" x 5.7"

C3
R11

MR
ML

128 caras
 128 sides



TABICA
Riser

14,5 x 120 cm
 5.7" x 47.2"

HS
MR
ML

EMBALAJE | PACKING

Formatos Formats	Piezas / Caja Pieces / Box	m ² / Caja sqm / Box	Kg / Caja Kg / Box	m ² / Palet sqm / Pallet	Tamaño palet Pallet size
60 x 120 ^R cm 23.6" x 47.2"	2	1,4400	34,37	46,08	120 x 84 x 74 cm
37,5 x 75 ^R cm 14.7" x 29.5"	4	1,1250	23,50	61,88	120 x 80 x 89 cm
14,7 x 14,7 cm 5.7" x 5.7"	44	0,9508	16,20	76,06	120 x 80 x 90 cm
Tabica Riser	6	-	22,20	-	125 x 110 x 90 cm
14,5 x 120 cm 5.7" x 47.2"					
Rodapié Skirting board	10	-	11,73	-	120 x 80 x 96 cm
9 x 60 cm 3.5" x 23.6"					

PELDAÑOS | STEPS

HUESO (HS)
 MARENGO (MR)
 MULTI (ML)

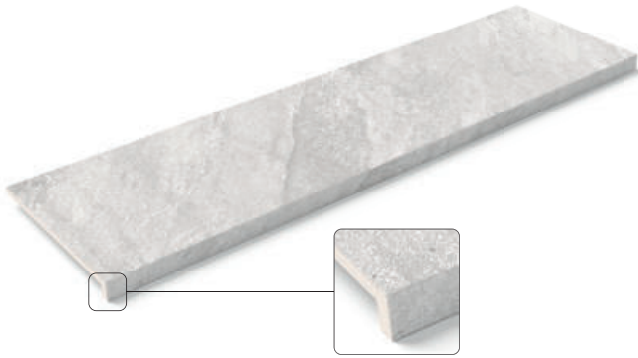

PELDAÑO
 Step
 MONOBLOCK

↗ 32,6 x 120 cm
↘ 12,8" x 47,2"

C3 R11 • HS MR ML

C1 R9 • HS

↓ 1,1 cm ↔ 3,4 cm
↑ 0,43" ↑ 1,3"

PELDAÑO
 TAPA
 Step cover

↗ 32,6 x 120 cm
↘ 12,8" x 47,2"

C3 R11 • HS MR ML

C1 R9 • HS



RODAPIE
 Skirting board

↗ 9 x 60 cm
↘ 3,5" x 23,6"

⊙

HS MR ML

BORDES PISCINA | POOL EDGES

HUESO (HS)
 MARENGO (MR)
 MULTI (ML)



CRETA

↗ 32,6 x 50 cm
↘ 12,8" x 19,7"

C3 R11 • 0° • 5%

HS MR ML

REJILLAS DE DRENAJE | *DRAIN GRATES*

 HUESO (HS)  MARENGO (MR)  MULTI (ML)



RJ25

Desagüe | *Drain* > 13 m³

 24,5 x 50 cm
9.6" x 19.7"

  ·  

Goma para rejilla 9710 incluida
Grate rubber 9710 included





RJ25 FLEX

Desagüe | *Drain* > 30 m³ / h

 24,5 x 50 cm
9.6" x 19.7"

  ·   

Goma para rejilla 9134 incluida
Grate rubber 9134 included

PIEZAS DE TERMINACIÓN | *TRIMS*

 HUESO (HS)  MARENGO (MR)  MULTI (ML)





64



Media caña exterior
Outer trims

Ref. MDCA E000

 4,5 x 50 cm
1.8" x 19.7"





  ·   



Escocia cantonera ext.
Covemolding outer corner

Ref. MDCA EE00

 4,5 x 4,5 cm
1.8" x 1.8"





  ·   



Esquina cantonera ext.
Outer angle corner

Ref. MDCA AE00

 6,5 x 6,5 cm
2.6" x 2.6"





  ·   



Media caña interior
Inner trims

Ref. MDCA I000

 5,5 x 50 cm
2.2" x 19.7"





  ·   



Escocia cantonera int.
Covemolding inner corner

Ref. MDCA EI00

 5,5 x 5,5 cm
2.2" x 2.2"





  ·   



Esquina cantonera int.
Inner angle corner

Ref. MDCA AI00

 6,5 x 6,5 cm
2.6" x 2.6"

  ·   



Cantonera transición ext.
External transition corner

Ref. MDCA CE00

↗ 4,5 x 25 cm
↘ 1.8" x 9.8"

C3
R11



Cantonera transición int.
Inner transition corner

Ref. MDCA CI00

↗ 5,5 x 25 cm
↘ 2.2" x 9.8"

C3
R11

*Información detallada sobre las piezas de terminación en las páginas 190 y 191.

*Detailed information about trims pieces in pages 190 and 191.

«Pizarra natural que convierte cada pieza en una obra única de carácter y belleza».

«Natural slate that makes each piece unique in character and beauty».





SALEM

«Procedente de las Islas Baleares, la piedra Mallorca evoca la esencia del Marés con su textura arenosa y su distintivo aspecto granular».

—
«Hailing from the Balearic Islands, Mallorca evokes the essence of Marés with its sandy texture and distinctive granular appearance».



67

Colección basada en la piedra Mallorca, conocida como “El Marés”, de las Islas Baleares. Es una arenisca compuesta de fragmentos acumulados en su superficie que la dotan de una estructura y aspecto granular arenoso.

—
Collection based on the Mallorca stone, known as “El Marés”, from the Balearic Islands. It is a sandstone composed of fragments accumulated on its surface that give it a sandy granular structure and appearance.







70

SALEM CLAR



SALEM DUNE

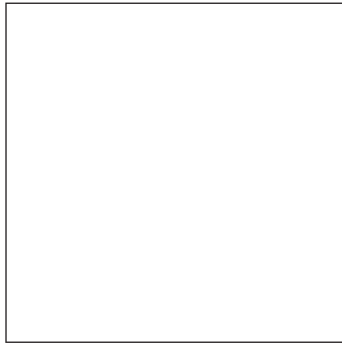

↖ ↗ 120 x 120 cm
47.2" x 47.2"

C3 R11 · C1 R9 ·

9 caras
9 sides

CL DN

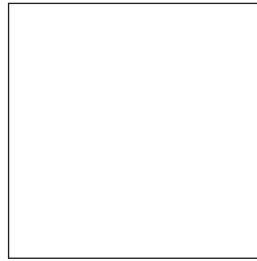

↖ ↗ 90 x 90 cm
35.4" x 35.4"

C3 R11 · C1 R9 ·

10 caras
10 sides

CL DN

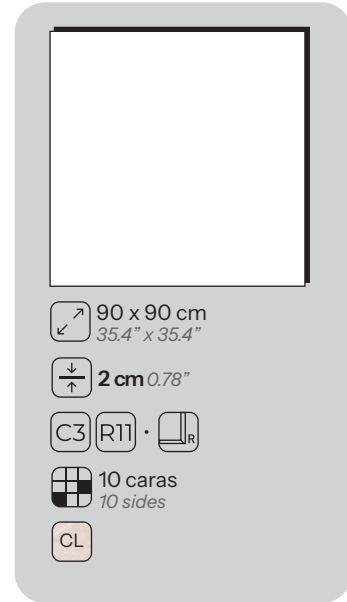

↖ ↗ 90 x 90 cm
35.4" x 35.4"

↕ 2 cm 0.78"

C3 R11 ·

10 caras
10 sides

CL



↖ ↗ 60 x 120 cm
23.6" x 47.2"

C3 R11 · C1 R9 ·

14 caras
14 sides

CL DN

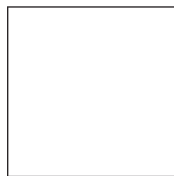

↖ ↗ 60 x 60 cm
23.6" x 23.6"

C3 R11 · C1 R9 ·

28 caras
28 sides

CL



TABICA
Riser

↖ ↗ 14,5 x 120 cm
5.7" x 47.2"

CL DN

EMBALAJE | PACKING

Formatos Formats	Piezas / Caja Pieces / Box	m ² / Caja sqm / Box	Kg / Caja Kg / Box	m ² / Palet sqm / Pallet	Tamaño palet Pallet size
120 x 120 ^R cm 47.2" x 47.2"	1	1,4400	30,13	57,60	126 x 126 x 67,1 cm
90 x 90 ^R cm 35.4" x 35.4"	2	1,6200	32,50	48,60	106 x 95 x 81 cm
90 x 90 ^R 2 cm 35.4" x 35.4" x 0.78"	1	0,8100	40,00	21,87	97 x 97 x 85 cm
60 x 120 ^R cm 23.6" x 47.2"	2	1,4400	34,37	46,08	120 x 84 x 74 cm
60 x 60 cm 23.6" x 23.6"	4	1,4400	27,00	46,08	120 x 80 x 74 cm
Tabica Riser	6	-	22,20	-	125 x 110 x 90 cm
14,5 x 120 cm 5.7" x 47.2"					
Rodapié Skirting board	10	-	11,73	-	120 x 80 x 96 cm
9 x 60 cm 3.5" x 23.6"					

PELDAÑOS | STEPS

CLAR (CL) DUNE (DN)

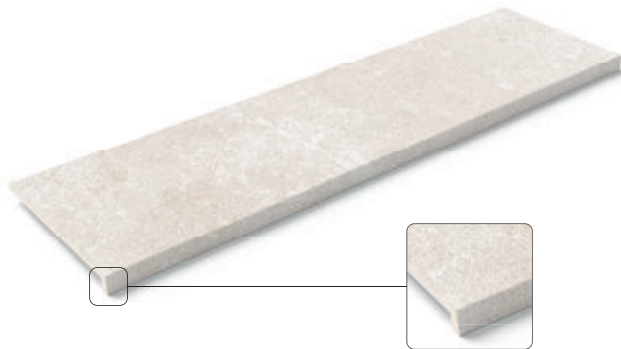

PELDAÑO
Step
MONOBLOCK

↗ ↙ 32,6 x 120 cm
12,8" x 47,2"
C3 R11 · C1 R9
↓ ↑ 1,1 cm 0,43" ↓ ↑ 3,4 cm 1,3"
CL DN



PELDAÑO
TAPA
Step cover

↗ ↙ 32,6 x 120 cm
12,8" x 47,2"
C3 R11 · C1 R9
CL DN

72



RODAPIE
Skirting board

↗ ↙ 9 x 60 cm
3,5" x 23,6"
○
CL DN

BORDES PISCINA | POOL EDGES

CLAR (CL) DUNE (DN)



CRETA

↗ ↙ 32,6 x 50 cm
12,8" x 19,7"
C3 R11 · 0° · 5%
CL DN



MAUI

↗ ↙ 32,6 x 50 cm
12,8" x 19,7"
C3 R11 · 0° · 5%
CL

BORDES PISCINA | POOL EDGES

CLAR (CL)

DUNE (DN)



SAMOA

50 x 120 cm
19.7" x 47.6"

C3 R11

CL

REJILLAS DE DRENAJE | DRAIN GRATES

CLAR (CL)

DUNE (DN)



73

RJ20

Desagüe | Drain > 11 m³ / h

19,3 x 50 cm
7.6" x 19.7"

C3 R11

CL

Goma para rejilla 9710 incluida
Grate rubber 9710 included

RJ20 FLEX

Desagüe | Drain > 30 m³ / h

19,3 x 50 cm
7.6" x 19.7"

C3 R11

CL

Goma para rejilla 9134 incluida
Grate rubber 9134 included

RJ25

Desagüe | Drain > 13 m³ / h

24,5 x 50 cm
9.6" x 19.7"

C3 R11

CL DN

Goma para rejilla 9710 incluida
Grate rubber 9710 included



RJ25 FLEX

Desagüe | Drain > 30 m³ / h

24,5 x 50 cm
9.6" x 19.7"

C3 R11

CL DN

Goma para rejilla 9134 incluida
Grate rubber 9134 included

RJ25 INV

Desagüe | Drain > 8 m³ / h

24,5 x 50 cm
9.6" x 19.7"

C3 R11

CL

Goma para rejilla 12719 incluida
Grate rubber 12719 included



Media caña exterior
Outer trims

Ref. MDCA E000

↗ 4,5 x 50 cm
↖ 1.8" x 19.7"

C3 R11 · CL DN



Escocia cantonera ext.
Covemolding outer corner

Ref. MDCA EE00

↗ 4,5 x 4,5 cm
↖ 1.8" x 1.8"

C3 R11 · CL DN



Esquina cantonera ext.
Outer angle corner

Ref. MDCA AE00

↗ 6,5 x 6,5 cm
↖ 2.6" x 2.6"

C3 R11 · CL DN



74

Media caña interior
Inner trims

Ref. MDCA I000

↗ 5,5 x 50 cm
↖ 2.2" x 19.7"

C3 R11 · CL DN



Escocia cantonera int.
Covemolding inner corner

Ref. MDCA EI00

↗ 5,5 x 5,5 cm
↖ 2.2" x 2.2"

C3 R11 · CL DN



Esquina cantonera int.
Inner angle corner

Ref. MDCA AI00

↗ 6,5 x 6,5 cm
↖ 2.6" x 2.6"

C3 R11 · CL DN



Cantonera transición ext.
External transition corner

Ref. MDCA CE00

↗ 4,5 x 25 cm
↖ 1.8" x 9.8"

C3 R11 · CL DN



Cantonera transición int.
Inner transition corner

Ref. MDCA CI00

↗ 5,5 x 25 cm
↖ 2.2" x 9.8"

C3 R11 · CL DN

*Información detallada sobre las piezas de terminación en las páginas 190 y 191.

*Detailed information about trims pieces in pages 190 and 191.





CORALINA AGUADA

CORALINA

«Piedra formada a partir de corales fósiles y otros animales marinos».

—
«Stone formed from fossil corals and other marine animals».



77

La Coralina es una piedra originaria del Caribe, formada a partir de corales fósiles y otros animales marinos desprendidos de los arrecifes. Está totalmente integrada en el estilo arquitectónico y escultórico local.

—
Coralina is a stone native to the Caribbean, formed from fossil corals and other marine animals that have broken off from reefs. This stone is fully integrated into the local architectural and sculptural style.



CORALINA AGUADA







80

CORALINA **AGUADA**

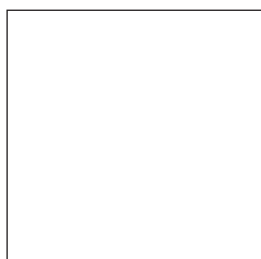

CORALINA **SAMANÁ**



 90 x 90 cm
35.4" x 35.4"



 24 caras
24 sides



 60 x 120 cm
23.6" x 47.2"



 24 caras
24 sides



 60 x 60 cm
23.6" x 23.6"



 30 caras
30 sides



TABICA
Riser

 14,5 x 120 cm
5.7" x 47.2"

EMBALAJE | PACKING

Formatos Formats	Piezas / Caja Pieces / Box	m ² / Caja sqm / Box	Kg / Caja Kg / Box	m ² / Palet sqm / Pallet	Tamaño palet Pallet size
90 x 90 ^R cm 35.4" x 35.4"	2	1,6200	32,50	48,60	106 x 95 x 81 cm
60 x 120 ^R cm 23.6" x 47.2"	2	1,4400	34,37	46,08	120 x 84 x 74 cm
60 x 60 ^R cm 23.6" x 23.6"	4	1,4400	27,00	46,08	120 x 80 x 74 cm
Tabica Riser	6	-	22,20	-	125 x 110 x 90 cm
14,5 x 120 cm 5.7" x 47.2"					
Rodapié Skirting board	10	-	11,73	-	120 x 80 x 96 cm
9 x 60 cm 3.5" x 23.6"					

PELDAÑOS | STEPS

AGUADA (AG) SAMANÁ (SM)



PELDAÑO
 Step
 MONOBLOCK

32,6 x 120 cm
 12,8" x 47,2"

C3 R11 · C1 R9

1,1 cm
 0,43"

3,4 cm
 1,3"

AG SM

PELDAÑO
 TAPA
 Step cover

32,6 x 120 cm
 12,8" x 47,2"

C3 R11 · C1 R9

AG SM

82



RODAPIE
 Skirting board

9 x 60 cm
 3,5" x 23,6"

AG SM

BORDES PISCINA | POOL EDGES

AGUADA (AG) SAMANÁ (SM)



CRETA

32,6 x 50 cm
 12,8" x 19,7"

C3 R11 · 0° · 5%

AG SM

REJILLAS DE DRENAJE | DRAIN GRATES

AGUADA (AG) SAMANÁ (SM)



RJ25

Desagüe | Drain > 13 m³

24,5 x 50 cm
9.6" x 19.7"



AG SM

Goma para rejilla 9710 incluida
Grate rubber 9710 included

RJ25 FLEX

Desagüe | Drain > 30 m³ / h

24,5 x 50 cm
9.6" x 19.7"



AG SM

Goma para rejilla 9134 incluida
Grate rubber 9134 included

RJ25 INV

Desagüe | Drain > 8 m³ / h

24,5 x 50 cm
9.6" x 19.7"



AG SM

Goma para rejilla 12719 incluida
Grate rubber 12719 included

PIEZAS DE TERMINACIÓN | TRIMS

AGUADA (AG) SAMANÁ (SM)



Media caña exterior

Outer trims

Ref. MDCA E000

4,5 x 50 cm
1.8" x 19.7"



Escocia cantonera ext.

Covemolding outer corner

Ref. MDCA EE00

4,5 x 4,5 cm
1.8" x 1.8"



Esquina cantonera ext.

Outer angle corner

Ref. MDCA AE00

6,5 x 6,5 cm
2.6" x 2.6"

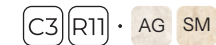

Media caña interior

Inner trims

Ref. MDCA I000

5,5 x 50 cm
2.2" x 19.7"



Escocia cantonera int.

Covemolding inner corner

Ref. MDCA EI00

5,5 x 5,5 cm
2.2" x 2.2"

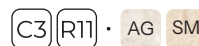

Esquina cantonera int.

Inner angle corner

Ref. MDCA AI00

6,5 x 6,5 cm
2.6" x 2.6"

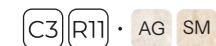



Cantonera transición ext.
External transition corner

Ref. MDCA CE00

4,5 x 25 cm
1.8" x 9.8"

C3 R11 · AG SM



Cantonera transición int.
Inner transition corner

Ref. MDCA CI00

5,5 x 25 cm
2.2" x 9.8"

C3 R11 · AG SM

*Información detallada sobre las piezas de terminación en las páginas 190 y 191.

*Detailed information about trims pieces in pages 190 and 191.

«Del Caribe a la arquitectura,
una piedra con carácter propio».

«From the Caribbean to architecture,
a stone with its own character».





CORALINA AGUADA



ETERNA

«Desde las canteras de la Toscana, Fior di Bosco revela un gris sofisticado con matices ahumados y vetas blancas y ocres que aportan distinción».

—
«From the quarries of Tuscany, Fior di Bosco reveals a sophisticated grey with smoky hues and white and ochre veins that lend distinction».



Inspirada en la piedra Fior Di Bosco, extraída de las canteras ubicadas en la Toscana. Su tono original es un elegante gris, repleto de matices plumizos y humo donde se intercalan vetas arborescentes en tonos blancos y ocres.

—
Inspired by Fior Di Bosco stone, extracted from quarries in Tuscany. Its original tone is an elegant grey, full of leaden and smoky nuances interspersed with tree-like veins in shades of white and ochre.



ETERNA **ALBA**





ETERNA CENDRA



ETERNA **ALBA**



ETERNA **ARGENT**



ETERNA **CENDRA**

FORMATOS | FORMATS

ALBA (AL) ARGENT (AG) CENDRA (CN)



60 x 120cm
23.6" x 47.2"



18 caras
18 sides



TABICA
Riser

14,5 x 120 cm
5.7" x 47.2"



EMBALAJE | PACKING

Formatos Formats	Piezas / Caja Pieces / Box	m ² / Caja sqm / Box	Kg / Caja Kg / Box	m ² / Palet sqm / Pallet	Tamaño palet Pallet size
60 x 120 ^R cm 23.6" x 47.2"	2	1,4400	34,37	46,08	120 x 84 x 74 cm
Tabica Riser	6	-	22,20	-	125 x 110 x 90 cm
14,5 x 120 cm 5.7" x 47.2"					
Rodapié Skirting board	10	-	11,73	-	120 x 80 x 96 cm
9 x 60 cm 3.5" x 23.6"					

92

PELDAÑOS | STEPS

ALBA (AL) ARGENT (AG) CENDRA (CN)



PELDAÑO
Step
MONOBLOCK

32,6 x 120 cm
12.8" x 47.2"



1,1 cm
0.43" 3,4 cm
1.3"



PELDAÑO
TAPA
Step cover

32,6 x 120 cm
12.8" x 47.2"



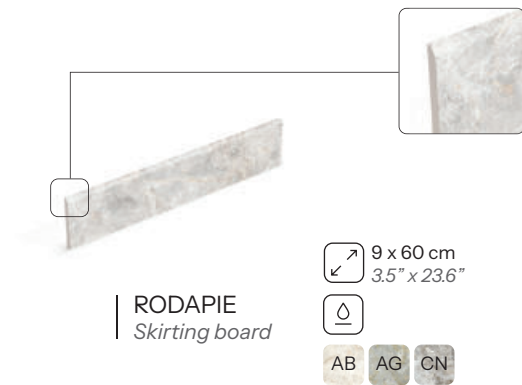

«Un gris sofisticado de la Toscana,
lleno de matices y vetas naturales».

93

«A sophisticated Tuscan grey,
full of natural nuances and veins».





ICONIC STONE

ICONIC

«Inspirada en la piedra Grigio Venato, combina un fondo profundo con vetas blancas que evocan la fuerza natural de los Alpes».

«Inspired by Grigio Venato stone, it combines a deep background with white veins that evoke the natural strength of the Alps».



95

Iconic nace de la piedra Grigio Venato de los Alpes, manteniendo su fuerza original. Cada cara resalta las características vetas blancas entremezcladas con su rico fondo.

Iconic is born from the Grigio Venato stone of the Alps, maintaining its original strength. Each face highlights the characteristic white veins interspersed with its rich background.



ICONIC **STONE**



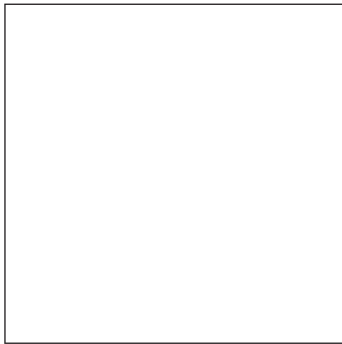

120 x 120 cm
47.2" x 47.2"

C3 R11 · C1 R9 · R

8 caras
8 sides

ST



60 x 120 cm
23.6" x 47.2"

C3 R11 · C1 R9 · R

16 caras
16 sides

ST



TABICA
Riser

14,5 x 120 cm
5.7" x 47.2"

ST

EMBALAJE | PACKING

98

Formatos Formats	Piezas / Caja Pieces / Box	m ² / Caja sqm / Box	Kg / Caja Kg / Box	m ² / Palet sqm / Pallet	Tamaño palet Pallet size
120 x 120 ^R cm 47.2" x 47.2"	1	1,4400	31,00	57,60	126 x 126 x 67,1 cm
60 x 120 ^R cm 23.6" x 47.2"	2	1,4400	34,37	46,08	120 x 80 x 75 cm
Tabica Riser	6	-	22,20	-	125 x 110 x 90 cm
14,5 x 120 cm 5.7" x 47.2"					
Rodapié Skirting board	10	-	11,73	-	120 x 80 x 96 cm
9 x 60 cm 3.5" x 23.6"					

PELDAÑOS | STEPS

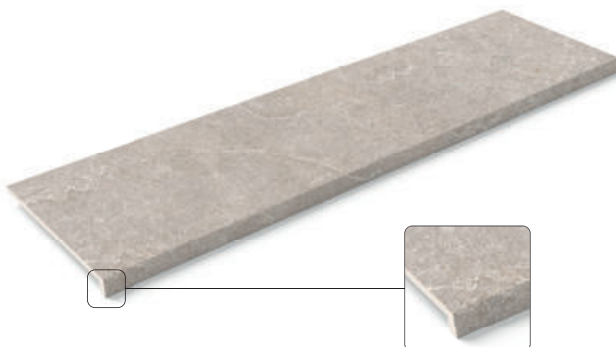

PELDAÑO
Step
MONOBLOCK

32,6 x 120 cm
12.8" x 47.2"

C3 R11 · C1 R9 · ST

1,1 cm
0.43" 3,4 cm
1.3"



PELDAÑO
TAPA
Step cover

32,6 x 120 cm
12.8" x 47.2"

C3 R11 · C1 R9

ST

PELDAÑOS | STEPS

STONE (ST)



RODAPIE
Skirting board

↗ ↙
9 x 60 cm
3.5" x 23.6"



ST

BORDES PISCINA | POOL EDGES

STONE (ST)



CRETA

↗ ↙
32,6 x 50 cm
12.8" x 19.7"



ST

99

REJILLAS DE DRENAJE | DRAIN GRATES

STONE (ST)



RJ25

Desagüe | Drain > 13 m³

↗ ↙
24,5 x 50 cm
9.6" x 19.7"



ST

Goma para rejilla 9710 incluida
Grate rubber 9710 included



RJ25 FLEX

Desagüe | Drain > 30 m³ / h

↗ ↙
24,5 x 50 cm
9.6" x 19.7"



ST



Goma para rejilla 9134 incluida
Grate rubber 9134 included



Media caña exterior

Outer trims

Ref. MDCA E000

 4,5 x 50 cm
 1.8" x 19.7"



  · 



Escocia cantonera ext.

Covemolding outer corner

Ref. MDCA EE00

 4,5 x 4,5 cm
 1.8" x 1.8"



  · 



Esquina cantonera ext.

Outer angle corner

Ref. MDCA AE00

 6,5 x 6,5 cm
 2.6" x 2.6"



  · 



Media caña interior

Inner trims

Ref. MDCA I000

 5,5 x 50 cm
 2.2" x 19.7"



  · 



Escocia cantonera int.

Covemolding inner corner

Ref. MDCA EI00

 5,5 x 5,5 cm
 2.2" x 2.2"



  · 



Esquina cantonera int.

Inner angle corner

Ref. MDCA AI00

 6,5 x 6,5 cm
 2.6" x 2.6"

  · 



100



Cantonera transición ext.

External transition corner

Ref. MDCA CE00

 4,5 x 25 cm
 1.8" x 9.8"



  · 



Cantonera transición int.

Inner transition corner

Ref. MDCA CI00

 5,5 x 25 cm
 2.2" x 9.8"

  · 

*Información detallada sobre las piezas de terminación en las páginas 190 y 191.

*Detailed information about trims pieces in pages 190 and 191.



ICONIC STONE



CALACATTA FRESH

CALACATTA

«Inspirada en el mármol Calacatta, despliega un fondo blanco roto con suaves vetas grises y delicados matices dorados».

—
«Inspired by Calacatta marble, it features an off-white background with soft grey veins and delicate golden shades».



Inspirada en el icónico mármol blanco italiano Calacatta, presenta un cromatismo singular, en el que un blanco roto de fondo y unas variadas vetas de color gris claro se ven puntualmente salpicadas por notas ambarinas y doradas.

—
Inspired by the iconic white Italian Calacatta marble, presents a singular chromaticism, in which an off-white background and varied light grey veins are punctuated by amber and golden notes.



CALACATTA **FRESH**





60 x 120 cm
23.6" x 47.2"



17 caras
17 sides

FR



TABICA
Riser

14,5 x 120 cm
5.7" x 47.2"

FR

EMBALAJE | PACKING

Formatos Formats	Piezas / Caja Pieces / Box	m ² / Caja sqm / Box	Kg / Caja Kg / Box	m ² / Palet sqm / Pallet	Tamaño palet Pallet size
60 x 120 ^R cm 23.6" x 47.2"	2	1,4400	34,37	46,08	120 x 80 x 75 cm
Tabica Riser 14,5 x 120 cm 5.7" x 47.2"	6	-	22,20	-	125 x 110 x 90 cm
Rodapié Skirting board 9 x 60 cm 3.5" x 23.6"	10	-	11,73	-	120 x 80 x 96 cm

106

PELDAÑOS | STEPS



PELDAÑO
Step
MONOBLOCK

32,6 x 120 cm
12.8" x 47.2"



1,1 cm
0.43" 3,4 cm
1.3"

FR



PELDAÑO
TAPA
Step cover

32,6 x 120 cm
12.8" x 47.2"

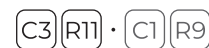

FR



RODAPIE
Skirting board

9 x 60 cm
3.5" x 23.6"



FR

«Un blanco roto y unas vetas de color gris claro se ven puntualmente salpicadas por notas ambarinas y doradas».

«Even off-white background and light grey veins are punctuated by amber and golden note».

107



CALACATTA FRESH



CEMENTS SNOW

CEMENTS

«Reproduce con fidelidad la textura del cemento, con sutiles variaciones y espatulados que aportan carácter, en una colección versátil para interiores y exteriores».

—
«It faithfully reproduces the texture of cement, with subtle variations and spatula marks that add character, in a versatile collection for interiors and exteriors».



109

La colección Cements apuesta por un cemento que reproduce fielmente la textura. Los detalles imitan las variaciones en el grano con sutiles espatulados y marcas, agregando interés visual. Diseñada para un uso versátil tanto en interiores como en exteriores.

—
The Cements collection features a very personal cement that faithfully reproduces the texture. Details mimic variations in the grain with subtle spatulations and markings, adding visual interest. It is designed for versatile use and can be installed both indoors and outdoors.



CEMENTS **SNOW**



nuevo
new

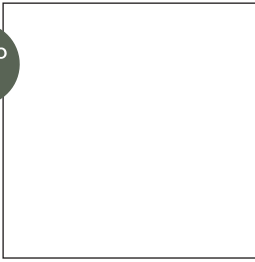

↖ ↗ 90 x 90 cm
35.4" x 35.4"

C3 R11 · C1 R9 · R

12 caras
12 sides

SN



↖ ↗ 60 x 120 cm
23.6" x 47.2"

C3 R11 · C1 R9 · R

12 caras
12 sides

SN



↖ ↗ 37,5 x 75 cm
14.7" x 29.5"

C3 R11 · R

28 caras
28 sides

SN



TABICA
Riser

↖ ↗ 14,5 x 120 cm
5.7" x 47.2"

SN

112

EMBALAJE | PACKING

Formatos Formats	Piezas / Caja Pieces / Box	m ² / Caja sqm / Box	Kg / Caja Kg / Box	m ² / Palet sqm / Pallet	Tamaño palet Pallet size
90 x 90 ^R cm 35.4" x 35.4"	2	1,6200	32,50	48,60	106 x 95 x 81 cm
60 x 120 ^R cm 23.6" x 47.2"	2	1,4400	33,7	46,08	120 x 84 x 74 cm
37,5 x 75 ^R cm 14.7" x 29.5"	4	1,1250	23,50	61,88	120 x 80 x 89 cm
Tabica Riser	6	-	22,20	-	125 x 110 x 90 cm
14,5 x 120 cm 5.7" x 47.2"					
Rodapié Skirting board	10	-	11,73	-	120 x 80 x 96 cm
9 x 60 cm 3.5" x 23.6"					

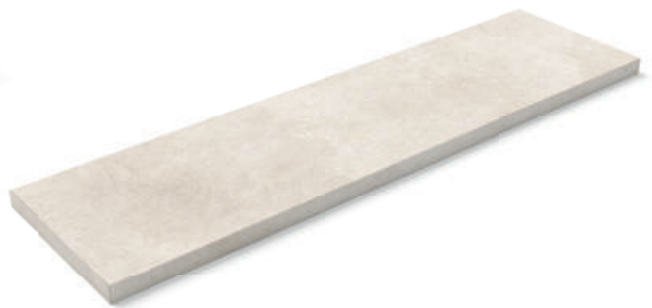

PELDAÑO
Step
MONOBLOCK

32,6 x 120 cm
 12.8" x 47.2"

C3 R11 · C1 R9

1,1 cm
 0,43"

3,4 cm
 1,3"

SN

PELDAÑO
TAPA
Step cover

32,6 x 120 cm
 12.8" x 47.2"

C3 R11 · C1 R9

SN



RODAPIE
Skirting board

9 x 60 cm
 3.5" x 23.6"

SN



CRETA

32,6 x 50 cm
 12.8" x 19.7"

C3 R11 · 0° · 5%

SN



RJ25

Desagüe | Drain > 13 m³

↗ 24,5 x 50 cm
↙ 9.6" x 19.7"



SN

Goma para rejilla 9710 incluida
Grate rubber 9710 included



RJ25 FLEX

Desagüe | Drain > 30 m³ / h

↗ 24,5 x 50 cm
↙ 9.6" x 19.7"



SN

Goma para rejilla 9134 incluida
Grate rubber 9134 included



Media caña exterior
Outer trims

Ref. MDCA E000

↗ 4,5 x 50 cm
↙ 1.8" x 19.7"



Escocia cantonera ext.
Covermolding outer corner

Ref. MDCA EE00

↗ 4,5 x 4,5 cm
↙ 1.8" x 1.8"



Esquina cantonera ext.
Outer angle corner

Ref. MDCA AE00

↗ 6,5 x 6,5 cm
↙ 2.6" x 2.6"



Media caña interior
Inner trims

Ref. MDCA I000

↗ 5,5 x 50 cm
↙ 2.2" x 19.7"



Escocia cantonera int.
Covermolding inner corner

Ref. MDCA EI00

↗ 5,5 x 5,5 cm
↙ 2.2" x 2.2"



Esquina cantonera int.
Inner angle corner

Ref. MDCA AI00

↗ 6,5 x 6,5 cm
↙ 2.6" x 2.6"



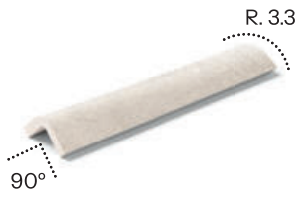

Cantonera transición ext.
External transition corner

Ref. MDCA CE00

4,5 x 25 cm
1.8" x 9.8"

C3 R11 · SN



Cantonera transición int.
Inner transition corner

Ref. MDCA CI00

5,5 x 25 cm
2.2" x 9.8"

C3 R11 · SN

*Información detallada sobre las piezas de terminación en las páginas 190 y 191.

*Detailed information about trims pieces in pages 190 and 191.

«Los detalles imitan las variaciones en el grano con sutiles espatulados y marcas».

«Details mimic variations in the grain with subtle spatulations and markings».





GOT TO BOHO

COTTO

«La fusión entre piezas antiguas y nuevas creaciones artesanales da como resultado una propuesta de gran calidez y carácter atemporal».

—
«The fusion of antique pieces and new handcrafted creations results in a design with great warmth and timeless character».



117

Cotto nace de la mezcla de piezas recuperadas en antiguas villas junto a nuevas creaciones hechas a mano. La unión de todas ellas, y un meticuloso tratamiento para suavizar su apariencia, aporta al conjunto un sólido carácter estético.

—
Cotto was born from the mixture of pieces recovered from old villas houses together with new handmade creations. The union of all of them, and a meticulous treatment to soften their appearance, gives the whole a solid aesthetic character.





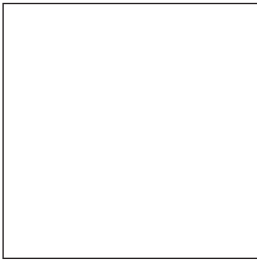

90 x 90 cm
35.4" x 35.4"



15 caras
15 sides

BO



TABICA
Riser

14,5 x 120 cm
5.7" x 47.2"

BO

EMBALAJE | PACKING

120

Formatos Formats	Piezas / Caja Pieces / Box	m ² / Caja sqm / Box	Kg / Caja Kg / Box	m ² / Palet sqm / Pallet	Tamaño palet Pallet size
90 x 90 ^o cm 35.4" x 35.4"	2	1,6200	32,50	48,60	106 x 95 x 81 cm
Tabica Riser 14,5 x 120 cm 5.7" x 47.2"	6	-	22,20	-	125 x 110 x 90 cm
Rodapié Skirting board 9 x 60 cm 3.5" x 23.6"	10	-	11,73	-	120 x 80 x 96 cm

PELDAÑOS | STEPS

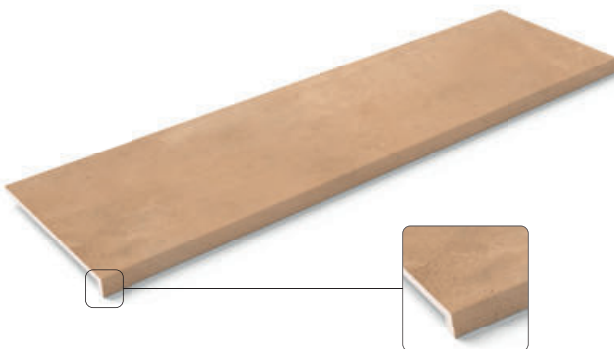

PELDAÑO
Step
MONOBLOCK

32,6 x 120 cm
12.8" x 47.2"



1,1 cm
0.43" 3,4 cm
1.3"

BO

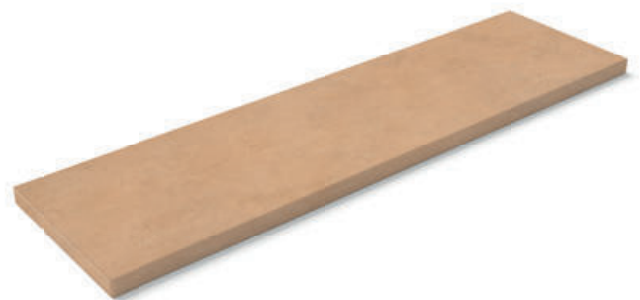

PELDAÑO
TAPA
Step cover

32,6 x 120 cm
12.8" x 47.2"



BO

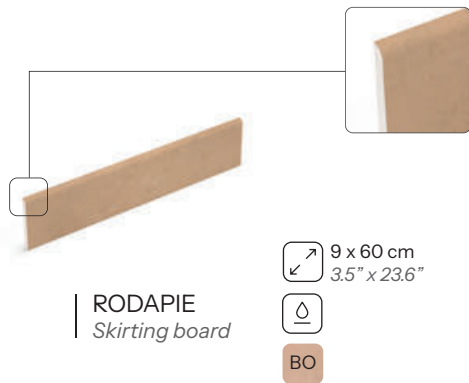

RODAPIE
Skirting board

9 x 60 cm
3.5" x 23.6"



BO

«La colección refleja la armonía entre tradición y artesanía, ofreciendo una estética cálida y refinada».

«The collection reflects the harmony between tradition and craftsmanship, offering a warm and refined aesthetic».





AMAZONIA

«Con vetas y nudos que evocan el roble, aporta carácter y versatilidad para integrarse en espacios modernos o tradicionales».

—
«With grain and knots reminiscent of oak, it adds character and versatility to blend into both modern and traditional spaces».



123

Amazonia emula la madera de roble blanco. Sus vetas y nudos distintivos recorren la superficie, aportando una textura con carácter y versatilidad, permitiendo que se adapte tanto a ambientes modernos como a estilos más tradicionales.

—
Amazonia emulates white oak wood. Its distinctive grain and knots run through the surface of the wood, providing a texture with character and versatility, allowing it to suit both modern environments and more traditional styles.



124

AMAZONIA **MIEL**





126

AMAZONIA **MIEL**



AMAZONIA **CANELA**

FORMATOS | FORMATS

MIEL (ML) CANELA (CA)



30 x 120 cm
11.8" x 47.2"



20 caras
20 sides

ML CA



20 x 120 cm
7.8" x 47.2"



39 caras
39 sides

ML CA



TABICA
Riser

14,5 x 120 cm
5.7" x 47.2"

ML CA

EMBALAJE | PACKING

Formatos Formats	Piezas / Caja Pieces / Box	m ² / Caja sqm / Box	Kg / Caja Kg / Box	m ² / Palet sqm / Pallet	Tamaño palet Pallet size
30 x 120 ^R cm 11.8" x 47.2"	4	1,4400	29,00	57,60	120 x 80 x 74 cm
20 x 120 ^R cm 7.8" x 47.2"	7	1,6800	33,11	73,92	120 x 80 x 83 cm
Tabica Riser 14,5 x 120 cm 5.7" x 47.2"	6	-	22,20	-	125 x 110 x 90 cm
Rodapié Skirting board 9 x 60 cm 3.5" x 23.6"	10	-	11,73	-	120 x 80 x 96 cm

127

PELDAÑOS | STEPS

MIEL (ML) CANELA (CA)



PELDAÑO
Step
MONOBLOCK

32,6 x 120 cm
12.8" x 47.2"



1,1 cm
0.43" 3,4 cm
1.3"

ML CA



PELDAÑO
TAPA
Step cover

32,6 x 120 cm
12.8" x 47.2"

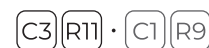

ML CA

PELDAÑOS | STEPS

MIEL (ML) CANELA (CA)



RODAPIE
Skirting board

9 x 60 cm
3.5" x 23.6"



ML CA

BORDES PISCINA | POOL EDGES

MIEL (ML) CANELA (CA)



CRETA

32,6 x 50 cm
12.8" x 19.7"



ML CA

128

REJILLAS DE DRENAJE | DRAIN GRATES

MIEL (ML) CANELA (CA)



RJ25

Desagüe | Drain > 13 m³

24,5 x 50 cm
9.6" x 19.7"



ML CA

Goma para rejilla 9710 incluida
Grate rubber 9710 included

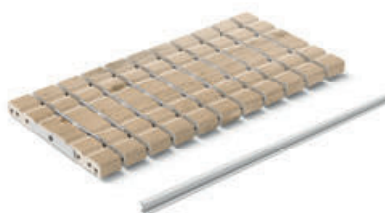

RJ25 FLEX

Desagüe | Drain > 30 m³ / h

24,5 x 50 cm
9.6" x 19.7"



ML CA

Goma para rejilla 9134 incluida
Grate rubber 9134 included



Media caña exterior

Outer trims

Ref. MDCA E000

 4,5 x 50 cm
1.8" x 19.7"

  •  



Escocia cantonera ext.

Covemolding outer corner

Ref. MDCA EE00

 4,5 x 4,5 cm
1.8" x 1.8"

  •  



Esquina cantonera ext.

Outer angle corner

Ref. MDCA AE00

 6,5 x 6,5 cm
2.6" x 2.6"

  •  



Media caña interior

Inner trims

Ref. MDCA I000

 5,5 x 50 cm
2.2" x 19.7"

  •  



Escocia cantonera int.

Covemolding inner corner

Ref. MDCA EI00

 5,5 x 5,5 cm
2.2" x 2.2"

  •  



Esquina cantonera int.

Inner angle corner

Ref. MDCA AI00

 6,5 x 6,5 cm
2.6" x 2.6"

  •  

129



Cantonera transición ext.

External transition corner

Ref. MDCA CE00

 4,5 x 25 cm
1.8" x 9.8"

  •  

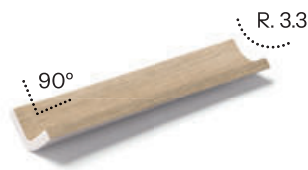

Cantonera transición int.

Inner transition corner

Ref. MDCA CI00

 5,5 x 25 cm
2.2" x 9.8"

  •  

*Información detallada sobre las piezas de terminación en las páginas 190 y 191.

*Detailed information about trims pieces in pages 190 and 191.



MIZU

«La colección Mizu nace de una mirada contemplativa de la naturaleza. Cada pieza revela una pequeña historia de tierra, viento y tiempo».

—
«The Mizu collection was born from a contemplative view of nature. Each piece reveals a small story of earth, wind, and time».



131

Es una superficie que no busca la perfección, es una mezcla de texturas y tonos que evocan paisajes, estados y sensaciones. Pensada para quienes valoran la expresión sincera de los materiales, esta colección aporta carácter y calidez a cualquier ambiente.

—
Is a surface that does not seek perfection, a mixture of textures and tones that evoke landscapes, states, and sensations. Designed for those who value the sincere expression of materials, this collection brings character and warmth to any environment.



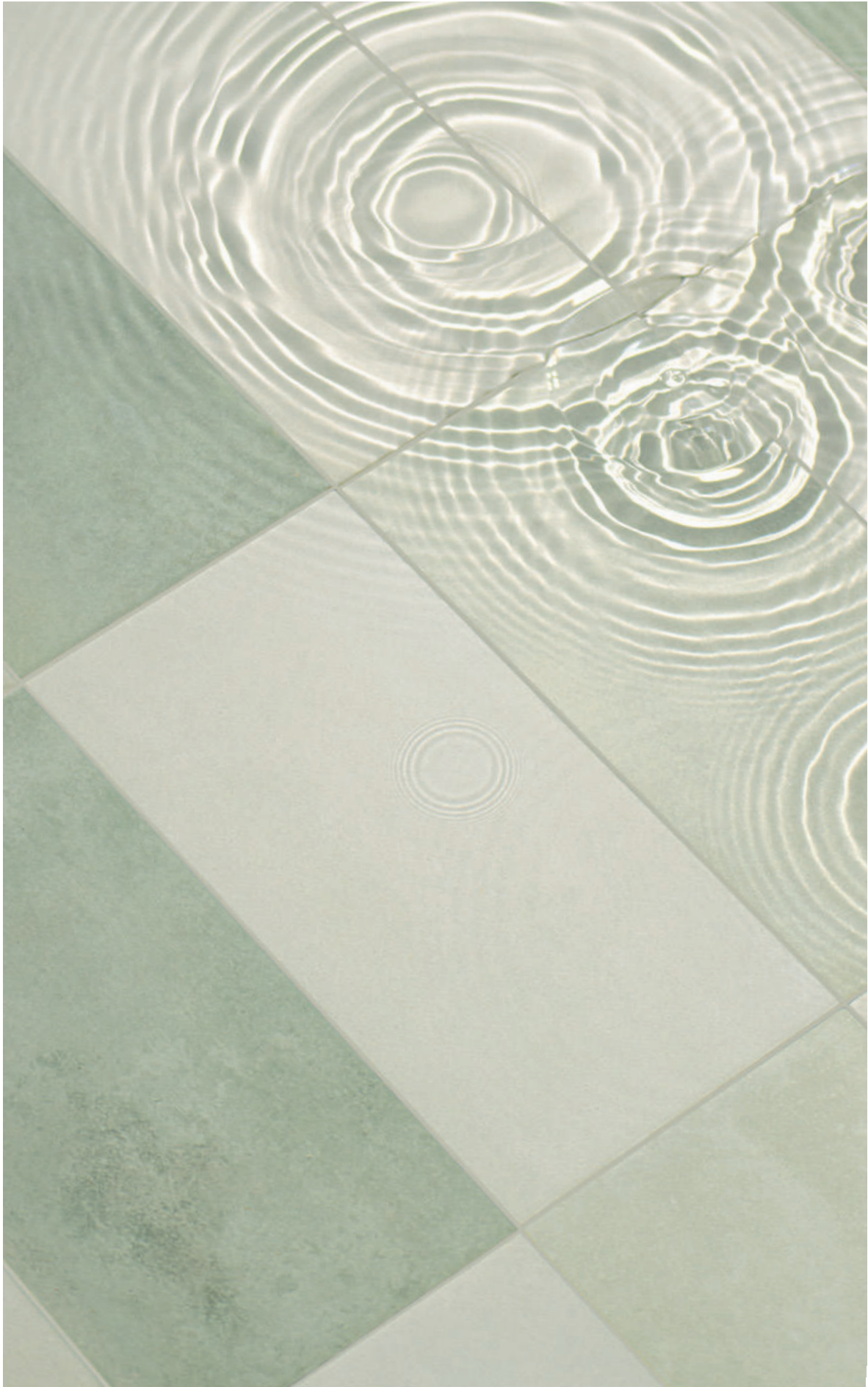



MIZU SHIRO



MIZU KAI



MIZU MIDORI

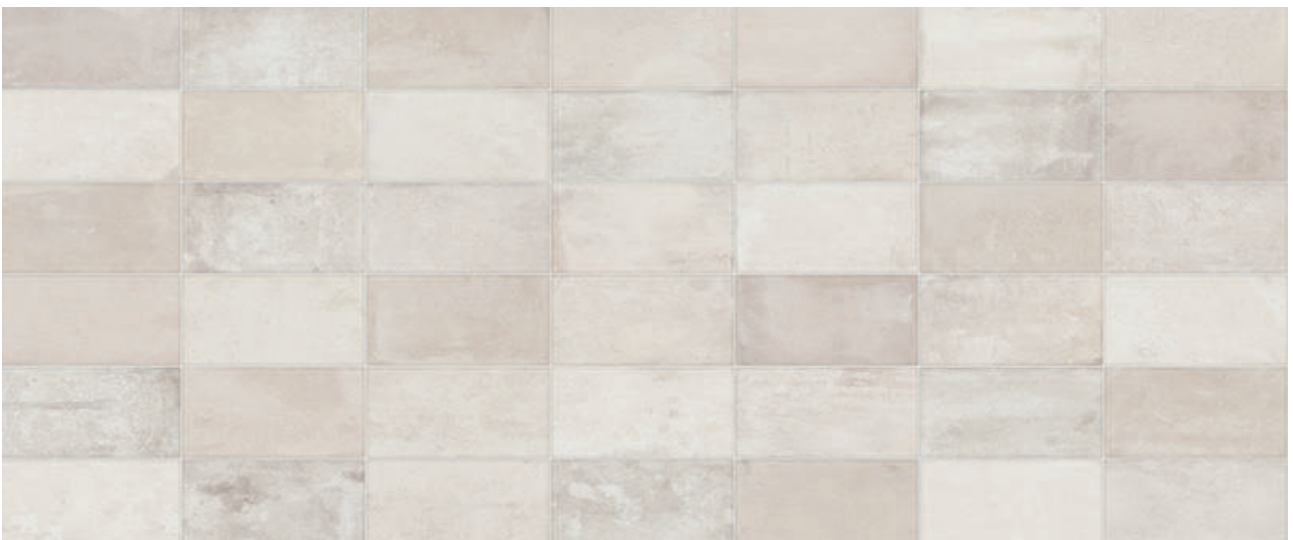

MIZU SHIRO



FORMATOS | FORMATS

 KAI (KA)  MIDORI (MI)  SHIRO (SH)



 11,5 x 23 cm
4,5" x 9"

 128 caras
128 sides

EMBALAJE | PACKING

Formatos Formats	Piezas / Caja Pieces / Box	m ² / Caja sqm / Box	Kg / Caja Kg / Box	m ² / Palet sqm / Pallet	Tamaño palet Pallet size
11,5 x 23 cm 4,5" x 9"	24	0,6348	9,00	64,74	120 x 80 x 90 cm

136

PIEZAS DE TERMINACIÓN | TRIMS

 KAI (KA)  MIDORI (MI)  SHIRO (SH)





Media caña exterior

Outer trims

Ref. MDCA E000

 4,5 x 50 cm
1,8" x 19,7"

  ·   







Escocia cantonera ext.

Covemolding outer corner

Ref. MDCA EE00

 4,5 x 4,5 cm
1,8" x 1,8"

  ·   







Esquina cantonera ext.

Outer angle corner

Ref. MDCA AE00

 6,5 x 6,5 cm
2,6" x 2,6"

  ·   







Media caña interior

Inner trims

Ref. MDCA I000

 5,5 x 50 cm
2,2" x 19,7"

  ·   







Escocia cantonera int.

Covemolding inner corner

Ref. MDCA EI00

 5,5 x 5,5 cm
2,2" x 2,2"

  ·   







Esquina cantonera int.

Inner angle corner

Ref. MDCA AI00

 6,5 x 6,5 cm
2,6" x 2,6"

  ·   

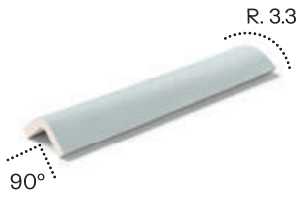

Cantonera transición ext.
External transition corner
 Ref. MDCA CE00

↗ 4,5 x 25 cm
↘ 1.8" x 9.8"

C3
R11 ·



Cantonera transición int.
Inner transition corner
 Ref. MDCA CI00

↗ 5,5 x 25 cm
↘ 2.2" x 9.8"

C3
R11 ·

*Información detallada sobre las piezas de terminación en las páginas 190 y 191.

*Detailed information about trims pieces in pages 190 and 191.

«Pensada para quienes valoran la expresión sincera de los materiales».

«Designed for those who value the sincere expression of materials».





TROPIC AGUAMARINA

TROPIC

«La fuerza del océano, un azul y verde volcánicos que convierte cada piscina en un paraíso en calma».

—
«The power of the ocean, a volcanic blue and green that transforms every pool into a peaceful paradise».



139

La colección Tropic surge de la fusión de diferentes rocas volcánicas sumada a piedras de una alta destonificación para conseguir un concepto de elevada variedad gráfica y cromática, logrando un resultado vistoso y espectacular.

—
The Tropic collection arises from the fusion of different volcanic rocks added to stones of high detonation to achieve a concept of high graphic and chromatic variety, achieving an eye-catching and spectacular result.

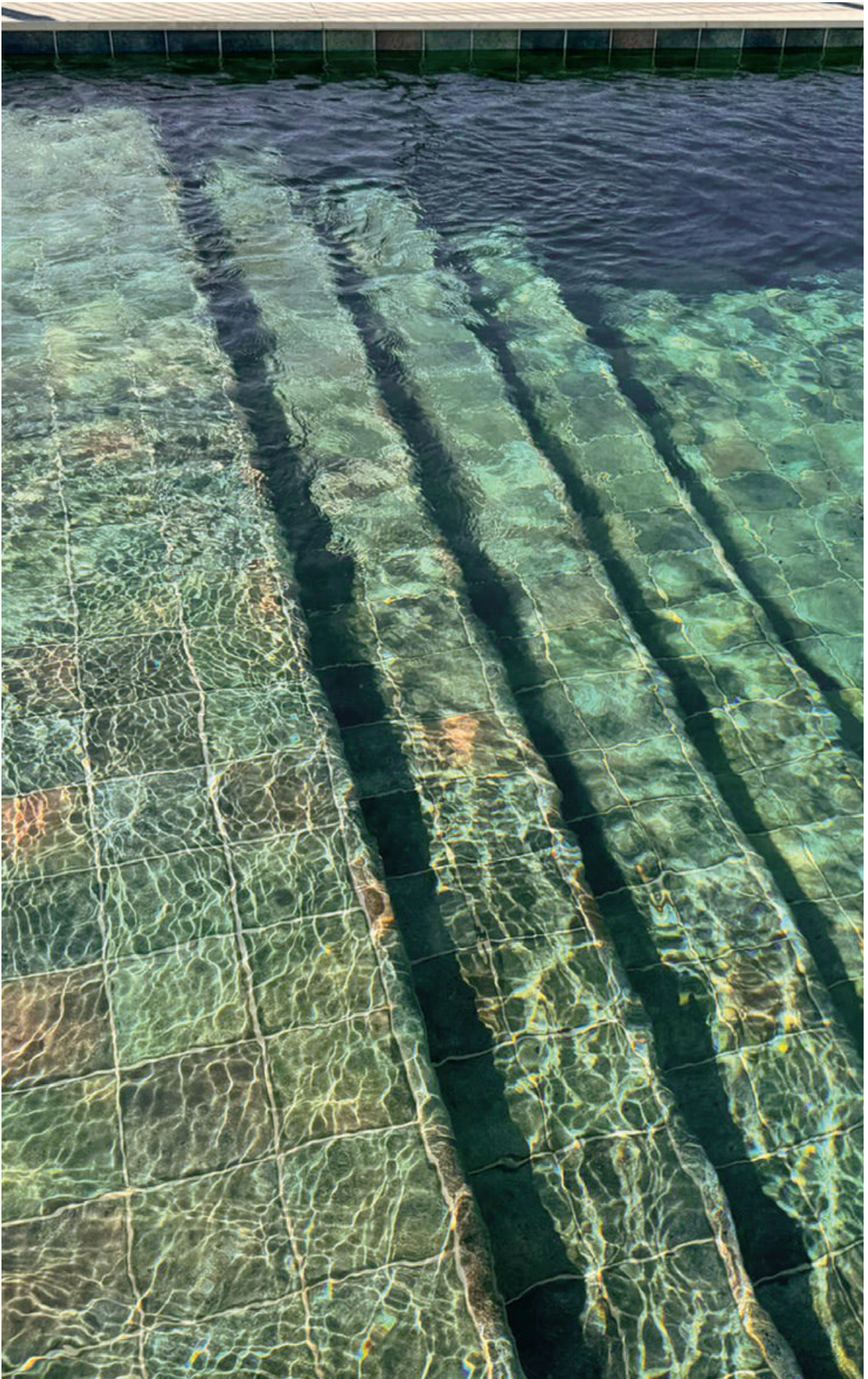

TROPIC TURQUETA



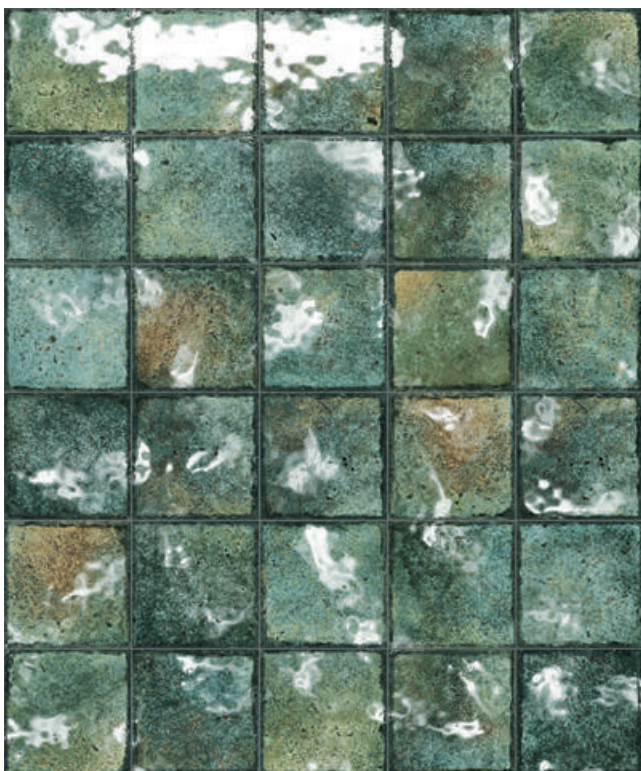

142

C3 R11

C1 R9

TROPIC **TURQUETA**

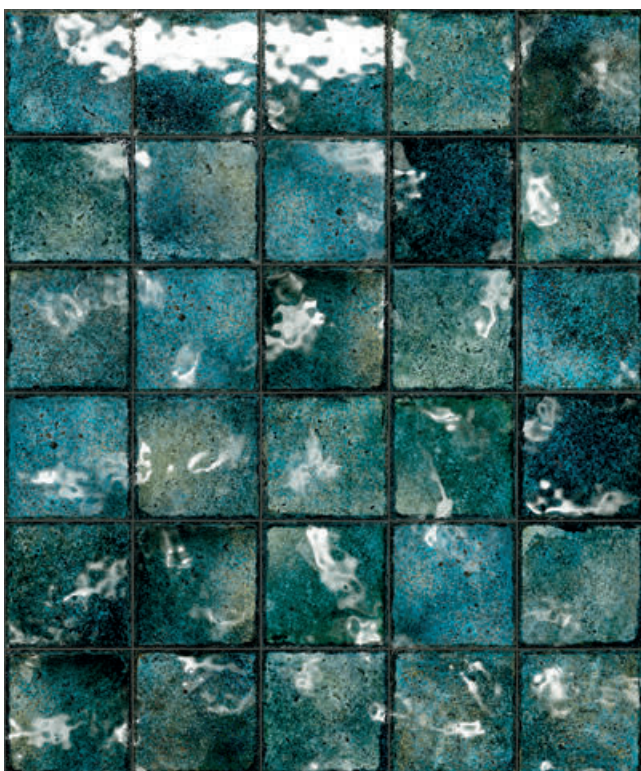

C3 R11

C1 R9

TROPIC **AGUAMARINA**

FORMATOS | FORMATS

 TURQUETA (TO)

 AGUAMARINA (AM)



 14,7 x 14,7 cm
5,7" x 5,7"

C3 R11 · C1 R9

 80 caras
80 sides

EMBALAJE | PACKING

Formatos Formats	Piezas / Caja Pieces / Box	m ² / Caja sqm / Box	Kg / Caja Kg / Box	m ² / Palet sqm / Pallet	Tamaño palet Pallet size
14,7 x 14,7* cm 5,7" x 5,7" OUT	44	0,9508	16,20	76,06	120 x 80 x 89 cm
14,7 x 14,7* cm 5,7" x 5,7" IN	44	0,9508	16,20	76,06	120 x 80 x 89 cm

PIEZAS DE TERMINACIÓN | TRIMS

 TURQUETA (TO)

 AGUAMARINA (AM)



Media caña exterior
Outer trims

Ref. MDCA E000

 4,5 x 50 cm
1,8" x 19,7"

C3 R11 · C1 R9 ·  



Escocia cantonera ext.
Covemolding outer corner

Ref. MDCA EE00

 4,5 x 4,5 cm
1,8" x 1,8"

C3 R11 · C1 R9 ·  



Esquina cantonera ext.
Outer angle corner

Ref. MDCA AE00

 6,5 x 6,5 cm
2,6" x 2,6"

C3 R11 · C1 R9 ·  



Media caña interior
Inner trims

Ref. MDCA I000

 5,5 x 50 cm
2,2" x 19,7"

C3 R11 · C1 R9 ·  



Escocia cantonera int.
Covemolding inner corner

Ref. MDCA EI00

 5,5 x 5,5 cm
2,2" x 2,2"

C3 R11 · C1 R9 ·  

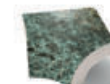

Esquina cantonera int.
Inner angle corner

Ref. MDCA AI00

 6,5 x 6,5 cm
2,6" x 2,6"

C3 R11 · C1 R9 ·  



Cantонера transición ext.
External transition corner

Ref. MDCA CE00

↗ 4,5 x 25 cm
↖ 1.8" x 9.8"

C3 R11 · C1 R9 · TO AM



Cantонера transición int.
Inner transition corner

Ref. MDCA CI00

↗ 5,5 x 25 cm
↖ 2.2" x 9.8"

C3 R11 · C1 R9 · TO AM

*Información detallada sobre las piezas de terminación en las páginas 190 y 191.

*Detailed information about trims pieces in pages 190 and 191.

«El lujo de sumergirse en un azul infinito».

144

«The luxury of immersing yourself in infinite blue».



TROPIC TURQUETA



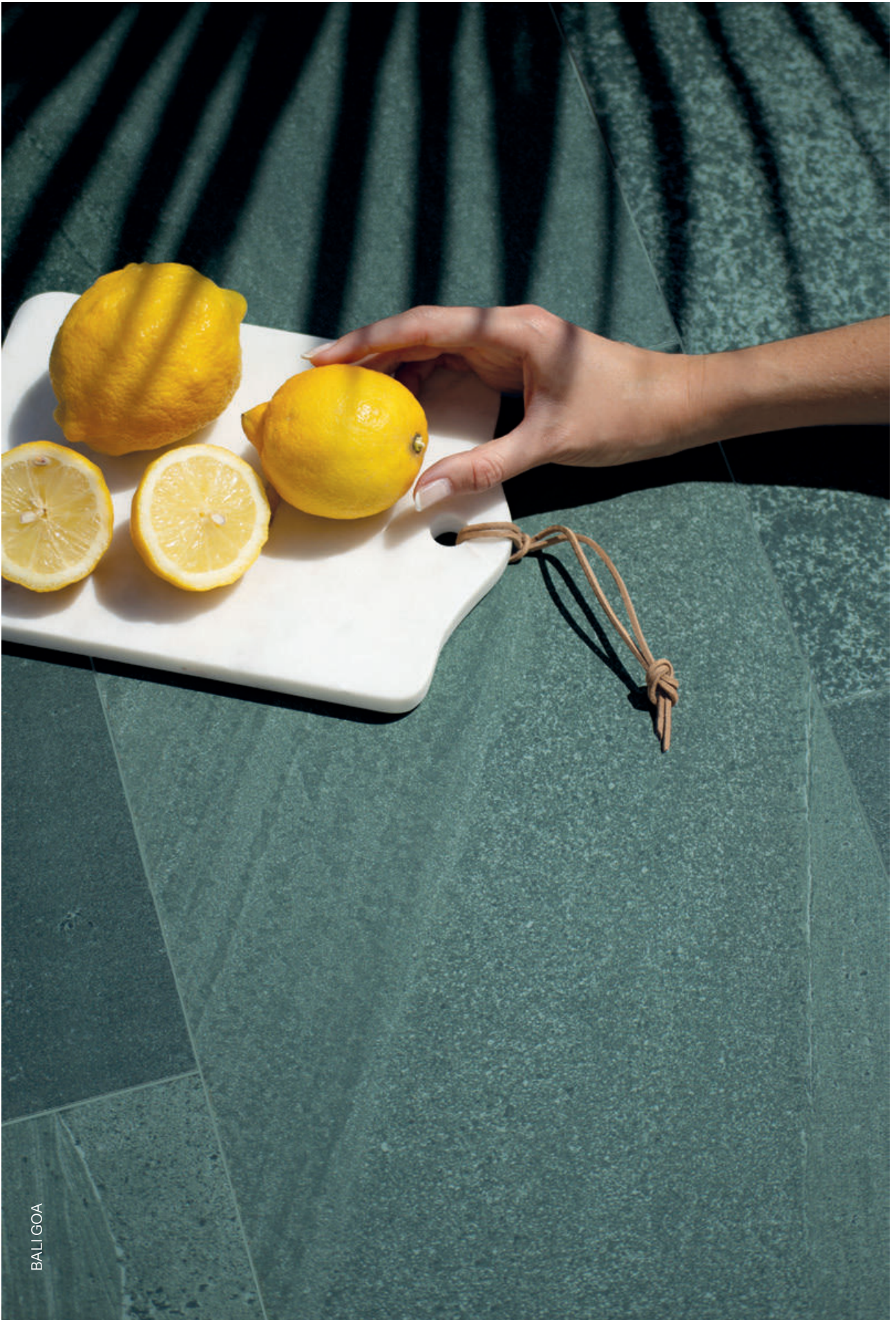

BALI

«Inspirada en la piedra natural Sukabumi, refleja la esencia tropical en un verde esmeralda».

—
«Inspired by Sukabumi natural stone, it reflects the tropical essence in a emerald green».

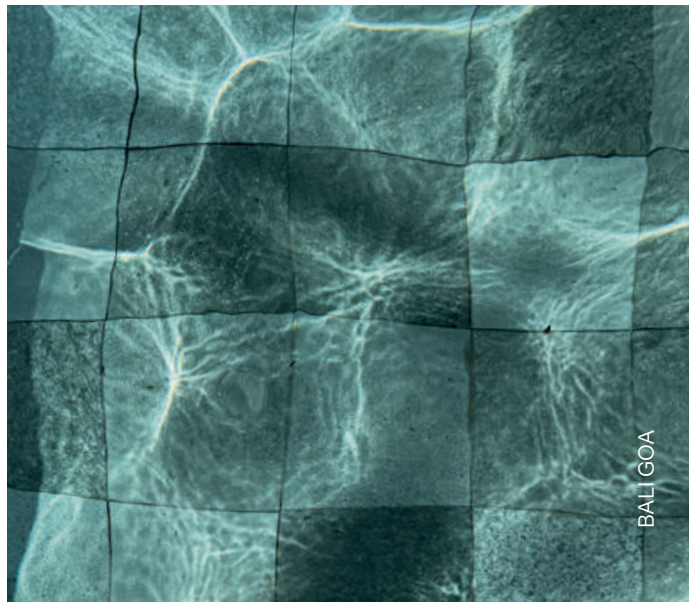

147

La piedra Bali o Sukabumi de Indonesia, es una variedad de piedra natural, formada por la acumulación de sedimentos. La característica más distintiva de Sukabumi es su color verde esmeralda y su gran diversidad gráfica, con vetas más claras u oscuras, así como áreas con matices más intensos de verdes y verdes-azulados.

—
Bali stone, or Sukabumi from Indonesia, is a variety of natural stone, formed by the accumulation of sediments. The most distinctive characteristic of Sukabumi is its emerald green colour and its great graphic diversity, with lighter or darker veins, as well as areas with more intense shades of green and blue-green.



BALI ZATU



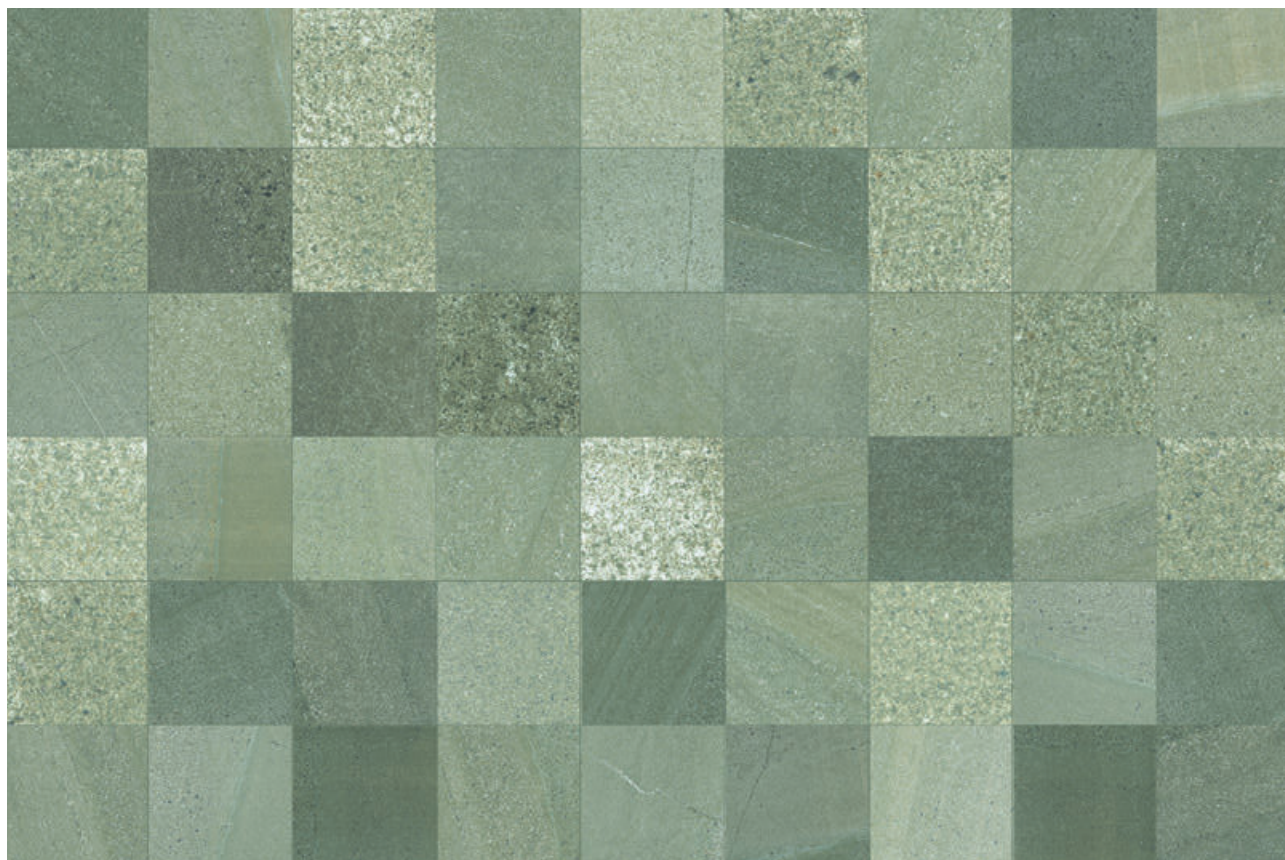

150

BALI ZATU



BALI GOA

FORMATOS | FORMATS

ZATU (ZA) GOA (GO)



30 x 60 cm
11.8" x 23.6"



30 caras
30 sides



14,7 x 14,7 cm
5.7" x 5.7"



84 caras
84 sides



EMBALAJE | PACKING

Formatos Formats	Piezas / Caja Pieces / Box	m ² / Caja sqm / Box	Kg / Caja Kg / Box	m ² / Palet sqm / Pallet	Tamaño palet Pallet size
30 x 60 ^R cm 11.8" x 23.6"	8	1,4400	27,00	57,60	120 x 80 x 74 cm
14,7 x 14,7* cm 5.7" x 5.7"	44	0,9508	16,20	76,06	120 x 80 x 90 cm

PELDAÑOS | STEPS

ZATU (ZA) GOA (GO)



PELDAÑO
Step
MONOBLOCK

32,6 x 120 cm
12.8" x 47.2"



1,1 cm 0.43" 3,4 cm 1.3"



PELDAÑO
TAPA
Step cover

32,6 x 120 cm
12.8" x 47.2"



BORDES PISCINA | POOL EDGES

ZATU (ZA) GOA (GO)



CRETA

32,6 x 50 cm
12.8" x 19.7"





Media caña exterior
Outer trims

Ref. MDCA E000

↗ 4,5 x 50 cm
↖ 1.8" x 19.7"

C3 R11 · ZA GO



Escocia cantonera ext.
Covemolding outer corner

Ref. MDCA EE00

↗ 4,5 x 4,5 cm
↖ 1.8" x 1.8"

C3 R11 · ZA GO



Esquina cantonera ext.
Outer angle corner

Ref. MDCA AE00

↗ 6,5 x 6,5 cm
↖ 2.6" x 2.6"

C3 R11 · ZA GO



Media caña interior
Inner trims

Ref. MDCA I000

↗ 5,5 x 50 cm
↖ 2.2" x 19.7"

C3 R11 · ZA GO



Escocia cantonera int.
Covemolding inner corner

Ref. MDCA EI00

↗ 5,5 x 5,5 cm
↖ 2.2" x 2.2"

C3 R11 · ZA GO



Esquina cantonera int.
Inner angle corner

Ref. MDCA AI00

↗ 6,5 x 6,5 cm
↖ 2.6" x 2.6"

C3 R11 · ZA GO

152



Cantonera transición ext.
External transition corner

Ref. MDCA CE00

↗ 4,5 x 25 cm
↖ 1.8" x 9.8"

C3 R11 · ZA GO

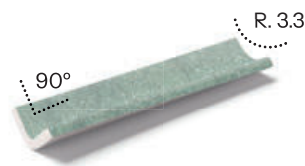

Cantonera transición int.
Inner transition corner

Ref. MDCA CI00

↗ 5,5 x 25 cm
↖ 2.2" x 9.8"

C3 R11 · ZA GO

*Información detallada sobre las piezas de terminación en las páginas 190 y 191.

*Detailed information about trims pieces in pages 190 and 191.



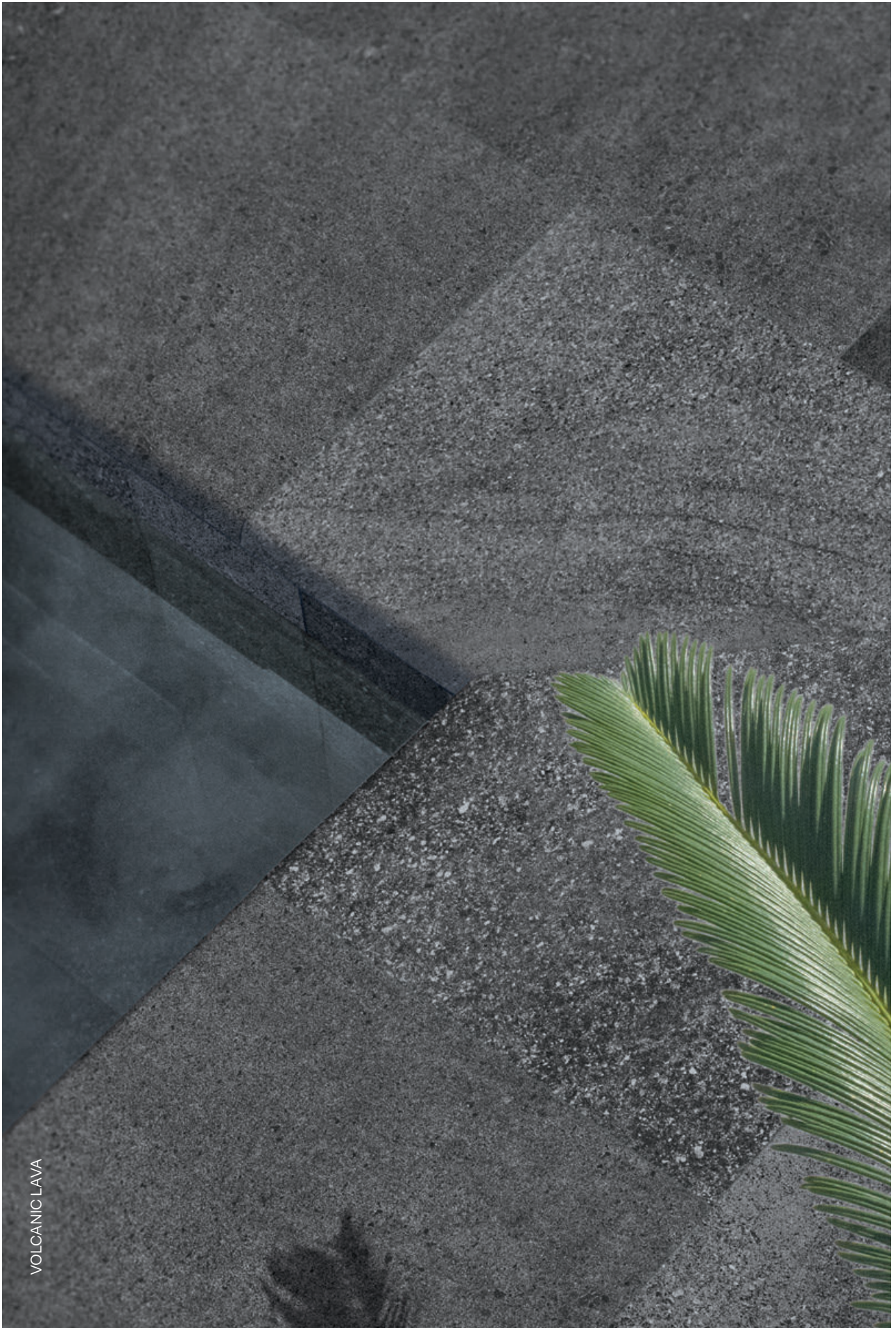

VOLCANIC LAVA

VOLCANIC

«Inspirada en la piedra basáltica, combina tonos del gris al negro intenso con fondos moteados y una textura porosa distintiva».

—
«Inspired by basalt stone, it combines shades of grey to deep black with mottled backgrounds and a distinctive porous texture».



155

Inspirada en el origen de la piedra basáltica, roca que nace de la rápida solidificación de la lava volcánica. De característico aspecto oscuro, con gamas de tonos que varían desde el gris oscuro hasta el negro más intenso. Presenta fondos moteados y textura porosa muy distintiva.

—
Inspired by the origin of basalt stone, a rock born from the rapid solidification of volcanic lava. With a characteristic dark appearance, with shades ranging from dark grey to the deepest black. It has mottled backgrounds, and a very distinctive porous texture.

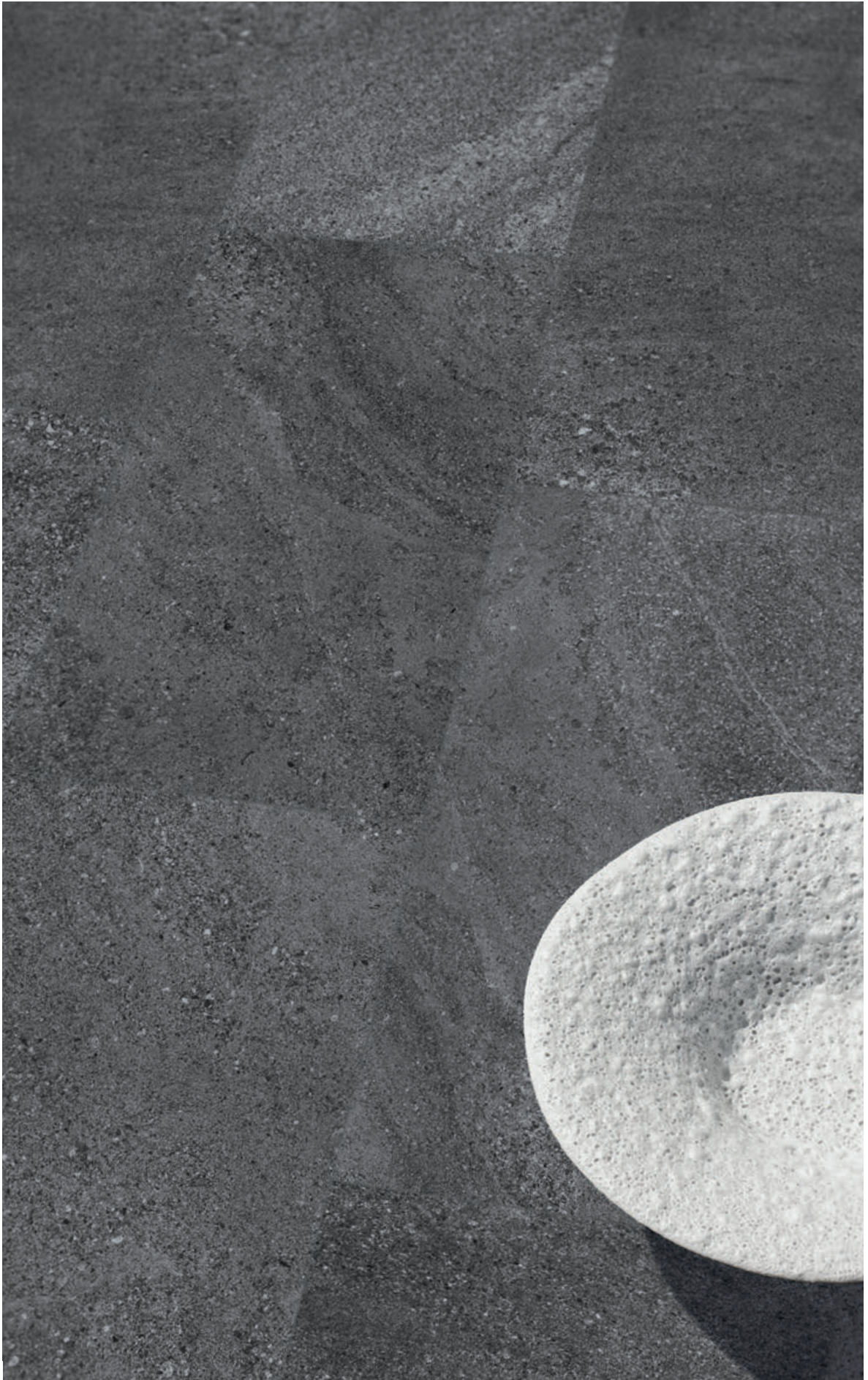

VOLCANIC LAVA

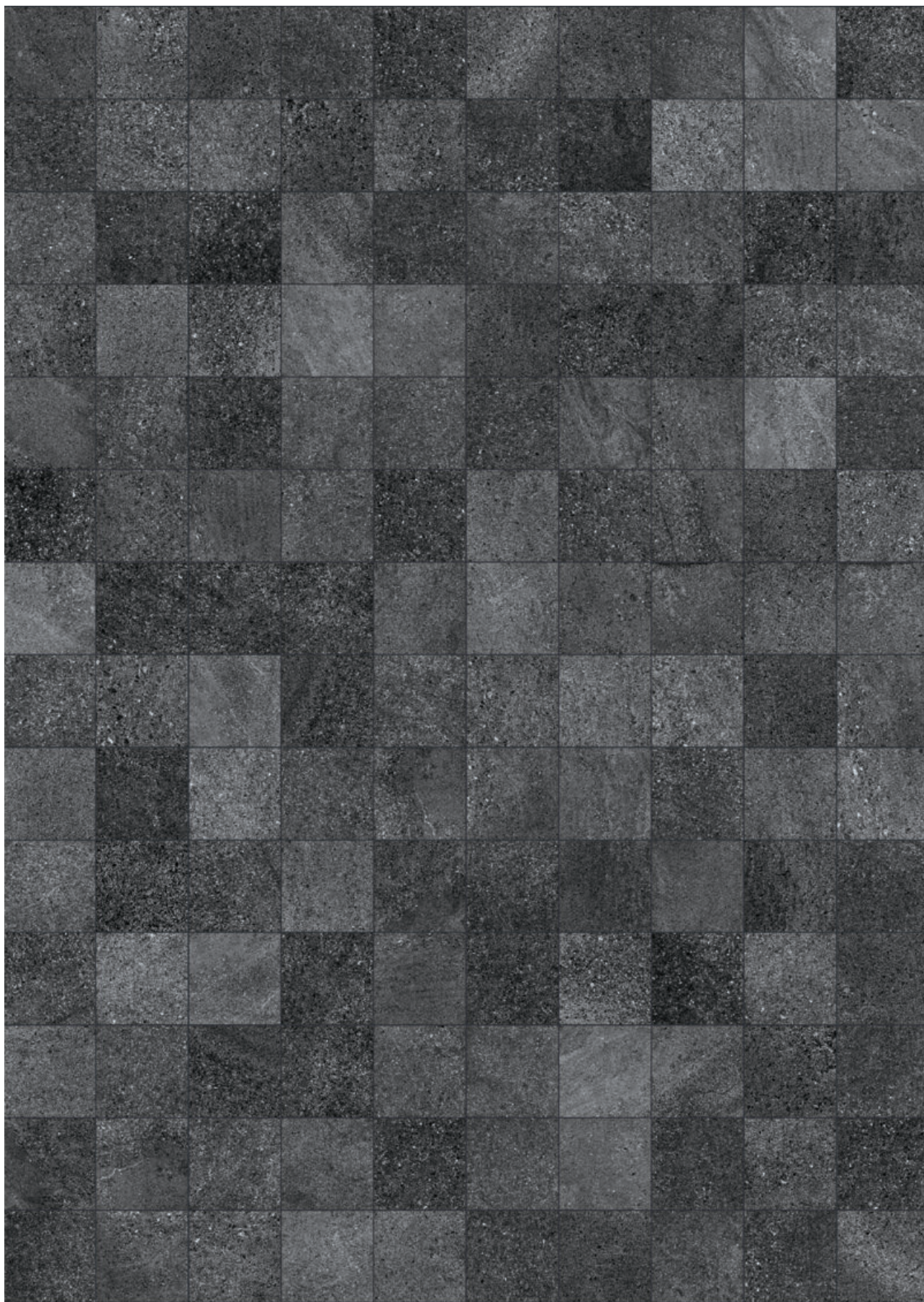

FORMATOS | FORMATS

LAVA (LV)



30 x 60 cm
11.8" x 23.6"



30 caras
30 sides



14,7 x 14,7 cm
5.7" x 5.7"



100 caras
100 sides



EMBALAJE | PACKING

Formatos Formats	Piezas / Caja Pieces / Box	m ² / Caja sqm / Box	Kg / Caja Kg / Box	m ² / Palet sqm / Pallet	Tamaño palet Pallet size
30 x 60 ^R cm 11.8" x 23.6"	8	1,4400	27,00	57,60	120 x 80 x 74 cm
14,7 x 14,7* cm 5.7" x 5.7" OUT	44	0,9508	16,97	76,06	120 x 80 x 90 cm

PELDAÑOS | STEPS

LAVA (LV)

158



PELDAÑO
Step
MONOBLOCK

32,6 x 120 cm
12.8" x 47.2"



1,1 cm 3,4 cm
0.43" 1.3"



PELDAÑO
TAPA
Step cover

32,6 x 120 cm
12.8" x 47.2"



PELDAÑO
COMPLETO
Full step

32,6 x 120 cm
12.8" x 47.2"





CRETA

↗ ↙ 32,6 x 50 cm
12.8" x 19.7"

C3 R11 · 0° · 5%

LV



RJ25

Desagüe | Drain > 13 m³

↗ ↙ 24,5 x 50 cm
9.6" x 19.7"

C3 R11 · I · G

LV

Goma para rejilla 9710 incluida
Grate rubber 9710 included

RJ25 FLEX

Desagüe | Drain > 30 m³ / h

↗ ↙ 24,5 x 50 cm
9.6" x 19.7"

C3 R11 · I · S · G

LV

Goma para rejilla 9134 incluida
Grate rubber 9134 included

RJ25 INV

Desagüe | Drain > 8 m³ / h

↗ ↙ 24,5 x 50 cm
9.6" x 19.7"

C3 R11 · I · G · 0°

LV

Goma para rejilla 12719 incluida
Grate rubber 12719 included



Media caña exterior

Outer trims

Ref. MDCA E000

↗ ↙ 4,5 x 50 cm
1.8" x 19.7"

C3 R11 · LV

Escocia cantonera ext.

Covemolding outer corner

Ref. MDCA EE00

↗ ↙ 4,5 x 4,5 cm
1.8" x 1.8"

C3 R11 · LV

Esquina cantonera ext.

Outer angle corner

Ref. MDCA AE00



↗ ↙ 6,5 x 6,5 cm
2.6" x 2.6"

C3 R11 · LV



Media caña interior
Inner trims

Ref. MDCA I000



 5,5 x 50 cm
 2.2" x 19.7"

  · 



Escocia cantonera int.
Covemolding inner corner

Ref. MDCA E100

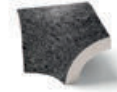

 5,5 x 5,5 cm
 2.2" x 2.2"

  · 



Esquina cantonera int.
Inner angle corner

Ref. MDCA A100

 6,5 x 6,5 cm
 2.6" x 2.6"

  · 



Cantonera transición ext.
External transition corner

Ref. MDCA CE00

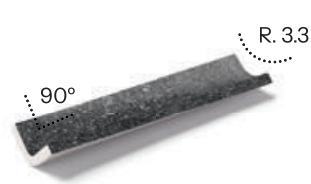

 4,5 x 25 cm
 1.8" x 9.8"

  · 



Cantonera transición int.
Inner transition corner

Ref. MDCA CI00

 5,5 x 25 cm
 2.2" x 9.8"

  · 

*Información detallada sobre las piezas de terminación en las páginas 190 y 191.

*Detailed information about trims pieces in pages 190 and 191.





PIEZAS ESPECIALES

Special Pieces

Colecciones
Collections

Piezas especiales
Special pieces

Sistemas constructivos piscinas
Pool construction systems

Colocación pavimento
Flooring installation

Colocación peldaños
Steps installation

Colocación piezas
especiales piscinas
*Installation of special
pool components*

162

- Peldaños / *Steps*
- Gres Porcelánico 20 mm / *20 mm Porcelain Stoneware*
- Borde / *Edge*
- Rejilla / *Grate*
- Medias cañas / *Trims*

«En Mayor diseñamos piezas extrusionadas
que amplían las posibilidades
de terrazas, piscinas y exteriores».

*«At Mayor, we design extruded pieces
that expand the possibilities for terraces,
swimming pools, and outdoor spaces».*

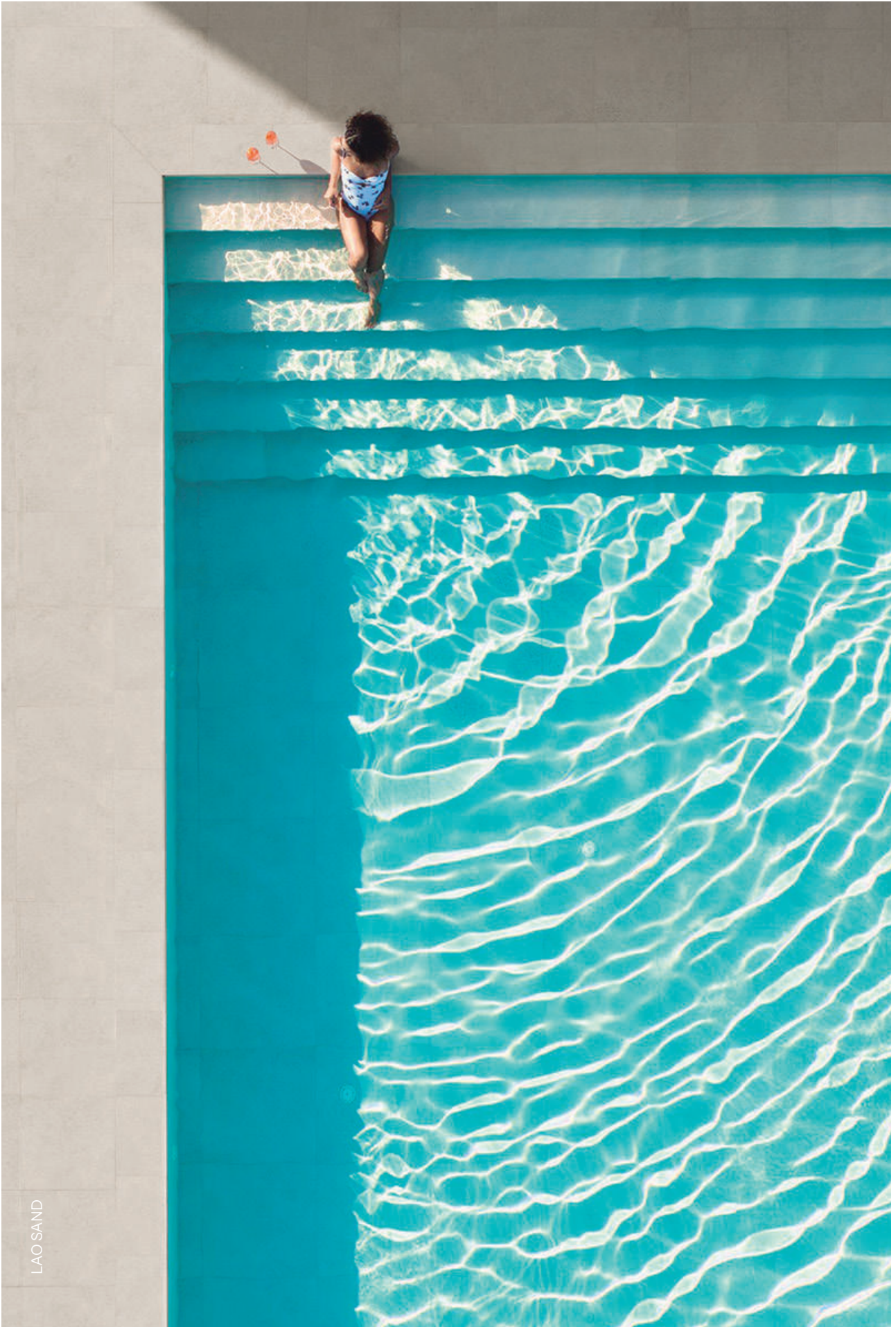

PELDAÑOS / STEPS

TIPOS DE PELDAÑOS | TYPE OF STEPS



Perfil en L
L-profile

PELDAÑO Step

C3 R11 · C1 R9

↗ 32,6 x 120 cm
12.8" x 47.2"

↕ 3,4 cm
1.3"

↕ 1,1 cm
0.43"

MONOBLOCK

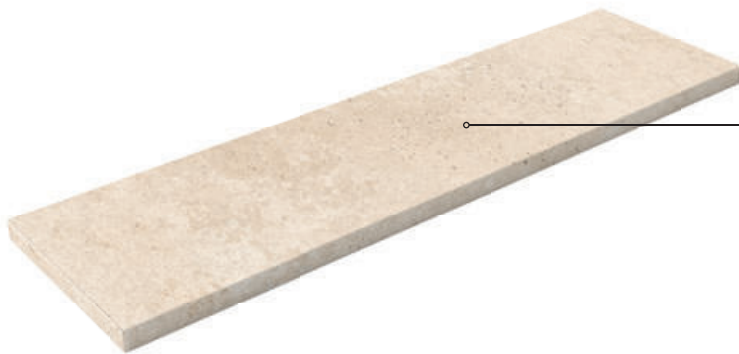

PELDAÑO TAPA Step cover

C3 R11 · C1 R9

↗ 32,6 x 120 cm
12.8" x 47.2"

↕ 3,4 cm
1.3"

↕ 1,1 cm
0.43"

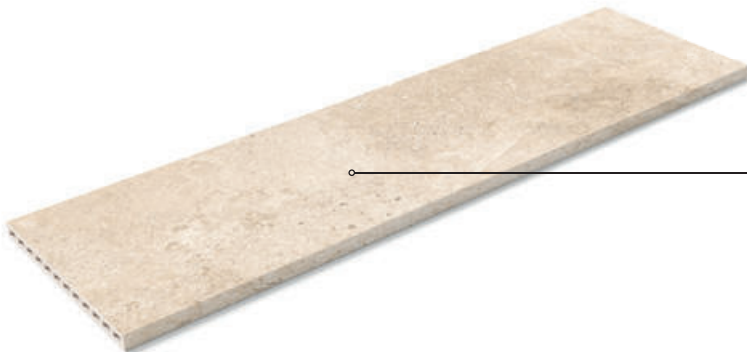

Perfil rectangular
Rectangular profile

PELDAÑO COMPLETO Full Step

C3 R11

↗ 32,6 x 120 cm
12.8" x 47.2"

↕ 2,4 cm
0.94"

MONOBLOCK

☉ Esmaltado
a 3 caras

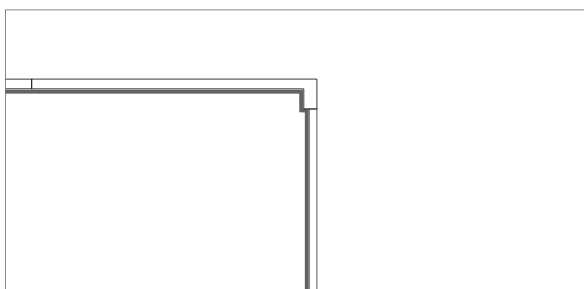
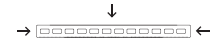

Colocación de peldaños como borde para piscina
Installation of steps as pool edging

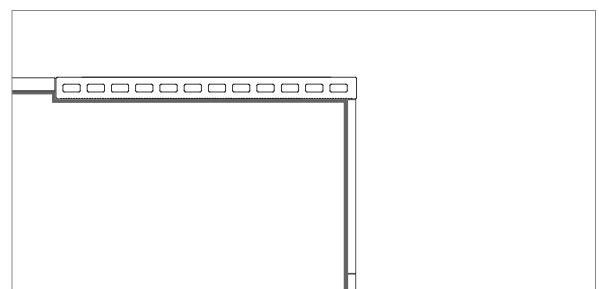

Colocación de peldaño completo como borde para piscina
Installation of full step as pool edging

20 MM

GRES PORCELÁNICO ESPESORADO | THICKENED PORCELAIN STONEWARE



En Mayor diseñamos pavimentos cerámicos específicamente pensados para exteriores. Nuestro gres porcelánico de 20 mm es la solución ideal para quienes necesitan un material resistente y funcional sin renunciar a la estética.

—
20 mm thick ceramic floor tiles offer a robust and safe solution, allowing them to be used in a wide variety of applications. They offer the perfect combination of strength and durability without ever compromising on aesthetics.

166

FORMATOS Y COLORES DISPONIBLES | AVAILABLE FORMATS AND COLOURS

A diagram illustrating the available tile formats and colors. On the left, there are two human silhouettes (a woman and a man) for scale. To their right, two tile samples are shown: a 60x120x2 cm tile and a 90x90x2 cm tile. The 60x120x2 cm tile is shown in four color options: Crosscut Puro (light beige), Crosscut Petra (tan), Crosscut Cloud (grey), and Stromboli Light (light brown). The 90x90x2 cm tile is shown in four color options: Savoy Moon (light beige), Savoy Desert (tan), Savoy Land (grey), and Salem Clar (light brown).

60 x 120 x 2 cm | 23.6" x 47.2" x 0.78"

- CROSSCUT PURO
- CROSSCUT PETRA
- CROSSCUT CLOUD
- STROMBOLI LIGHT

90 x 90 x 2 cm | 35.4" x 35.4" x 0.78"

- SAVOY MOON
- SAVOY DESERT
- SAVOY LAND
- SALEM CLAR

CARACTERÍSTICAS TÉCNICAS | TECHNICAL SPECIFICATIONS



Soporta condiciones atmosféricas adversas.
Endures adverse weather conditions.



Larga vida útil.
Long service life.



Antideslizante.
Anti-slip.



Fácil limpieza y mantenimiento.
Easy to clean and maintenance.



Resistencia al peso y tráfico personal.
Resistance to weight and personal traffic.



Instalación rápida y sencilla.
Easy and quick to install.



Resistencia a la flexión.
Flexion resistance.



Resistencia al desgaste y al tránsito.
Abrasion and traffic resistance.



Simplifica el diseño y optimiza recursos.
Simplify design and optimise resources.



Estética inalterable con el paso del tiempo.
Eternal: product and its colours are stable over time.



Continuidad visual entre el espacio interior y exterior.
Visual continuity of indoor and outdoor space.

167

ZONAS DE USO Y APLICACIONES | AREAS OF USE AND APPLICATIONS



01.
TERRAZAS
TERRACE

02.
PISCINAS
POOLS

03.
PARKING
PARKING

04.
URBANO
URBAN





05.
JARDINES
GARDENS

06.
BALCONES
BALCONIES

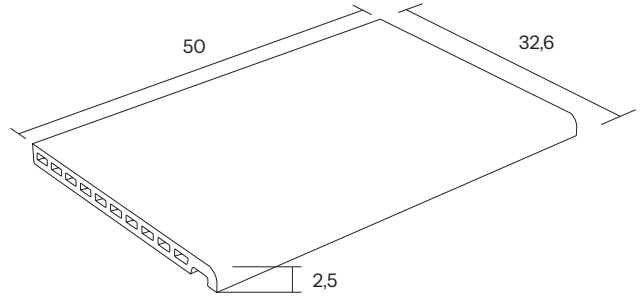
CRETA

BORDE DE PISCINA | POOL EDGE



-  32,6 x 50 cm
12.8" x 19.7"
-  Ref. BPCR 0000
-  5%
-  3 caras
3 sides

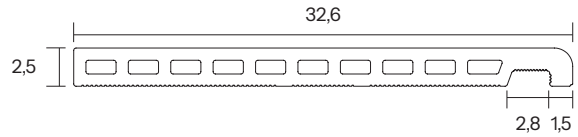

168

COLORES DISPONIBLES | AVAILABLE COLOURS



SOLUCIÓN CURVA | *CURVED SOLUTION*

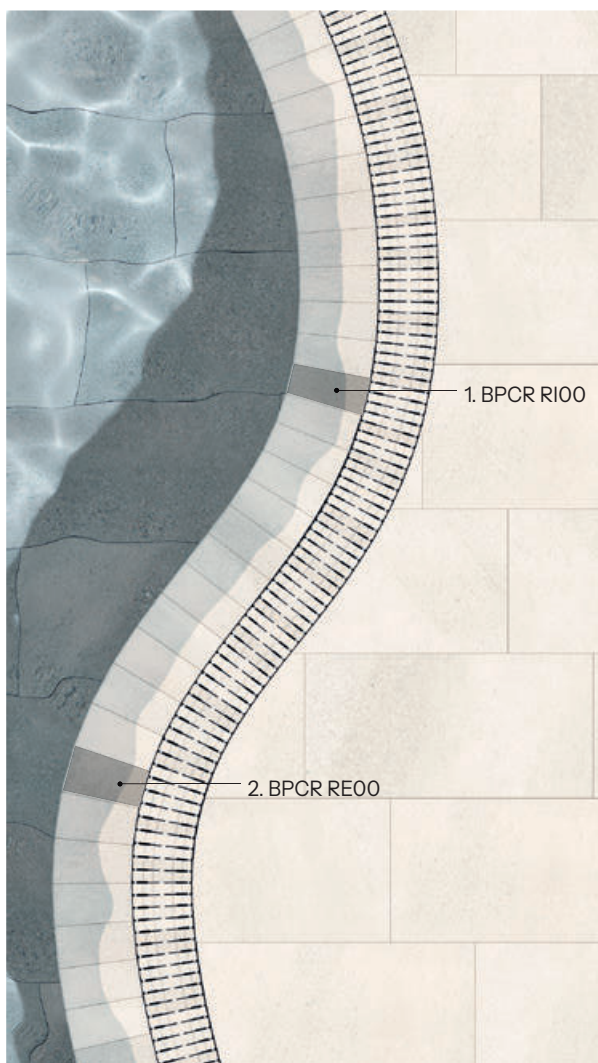

BORDE CURVO CRETA
CRETA CURVED EDGE

1. BPCR RI00
2. BPCR RE00

Compatible con las rejillas RJ25, RJ25 FLEX, RJ20, RJ20 FLEX y RJ25 INV
Can be used with drain grates RJ25, RJ25 FLEX, RJ20, RJ20 FLEX and RJ25 INV

SOLUCIÓN ESQUINA | *CORNER SOLUTION*

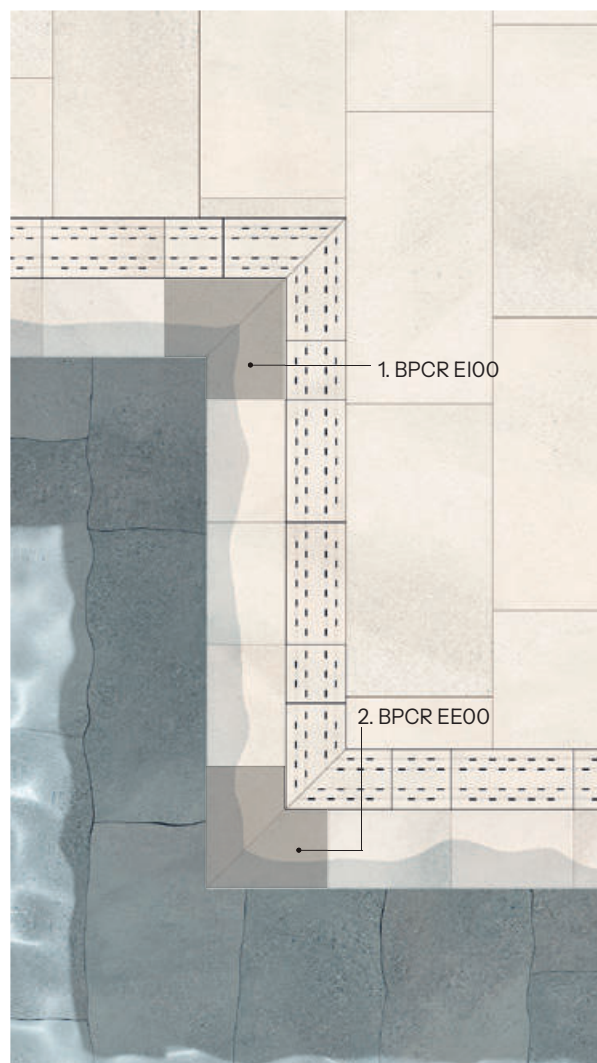

PACK ESQUINA BORDE CRETA (2 pzas)
CRETA EDGE CORNER PACK (2 pcs)

1. BPCR EI00 32,6 x 50 cm 12.8" x 19.7"
2. BPCR EE00 32,6 x 50 cm 12.8" x 19.7"

Compatible con las rejillas RJ25, RJ25 FLEX, RJ20, RJ20 FLEX y RJ25 INV
Can be used with drain grates RJ25, RJ25 FLEX, RJ20, RJ20 FLEX and RJ25 INV

INFORMACIÓN TÉCNICA | *TECHNICAL INFORMATION*

MONOBLOCK

UNA PIEZA, SIN PEGADO
ONE PIECE, WITHOUT GLUED



EN 16165
CLASE 3



EN ISO 10545-12
✓



EN 16165
R11



EN 16165
CLASE C



EN ISO 10545-13
GA / GLA / GHA



LARGA VIDA
LONG LIFE







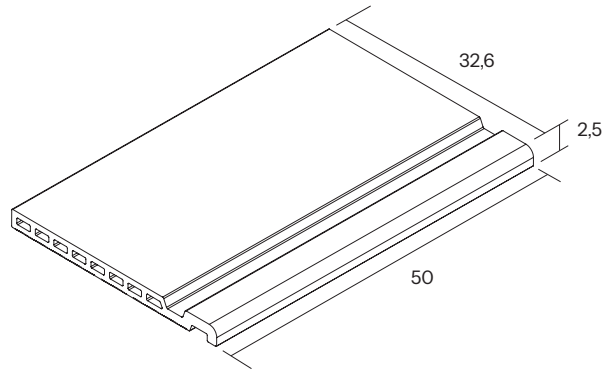

FÁCIL LIMPIEZA
EASY CLEAN

MAUI

BORDE DE PISCINA | POOL EDGE



-  32,6 x 50 cm
12,8" x 19,7"
-   Ref. BPMA 0000
-  5% 
-  3 caras
3 sides

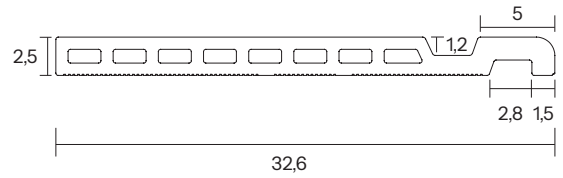

170

COLORES DISPONIBLES | AVAILABLE COLOURS



SOLUCIÓN CURVA | *CURVED SOLUTION*

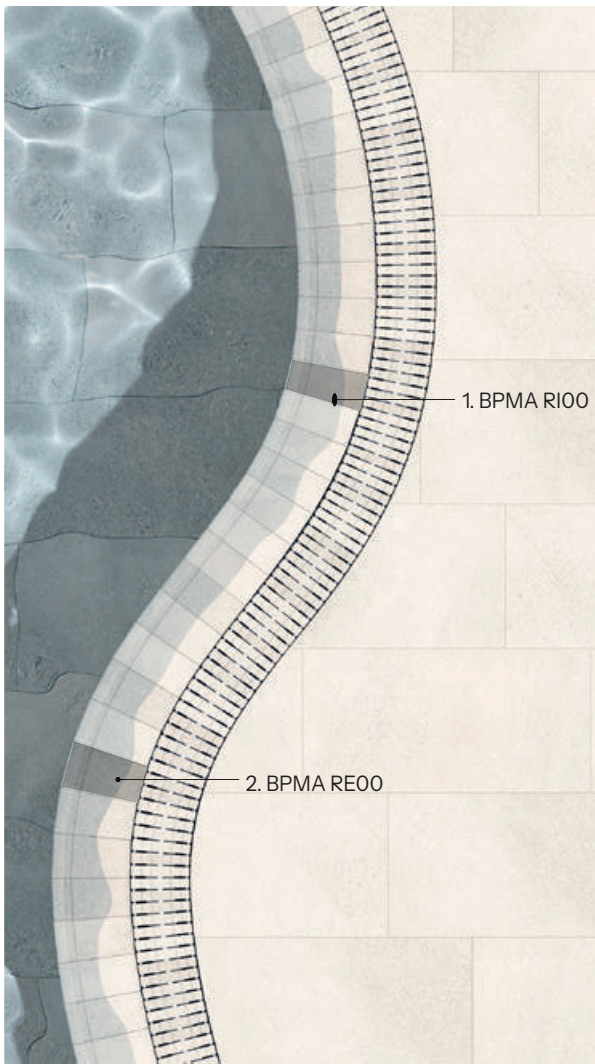

BORDE CURVO MAUI
MAUI CURVED EDGE

- 1. BPMA RIO0
- 2. BPMA RE00

Compatible con las rejillas RJ25, RJ25 FLEX, RJ20, RJ20 FLEX y RJ25 INV
Can be used with drain grates RJ25, RJ25 FLEX, RJ20, RJ20 FLEX and RJ25 INV

SOLUCIÓN ESQUINA | *CORNER SOLUTION*

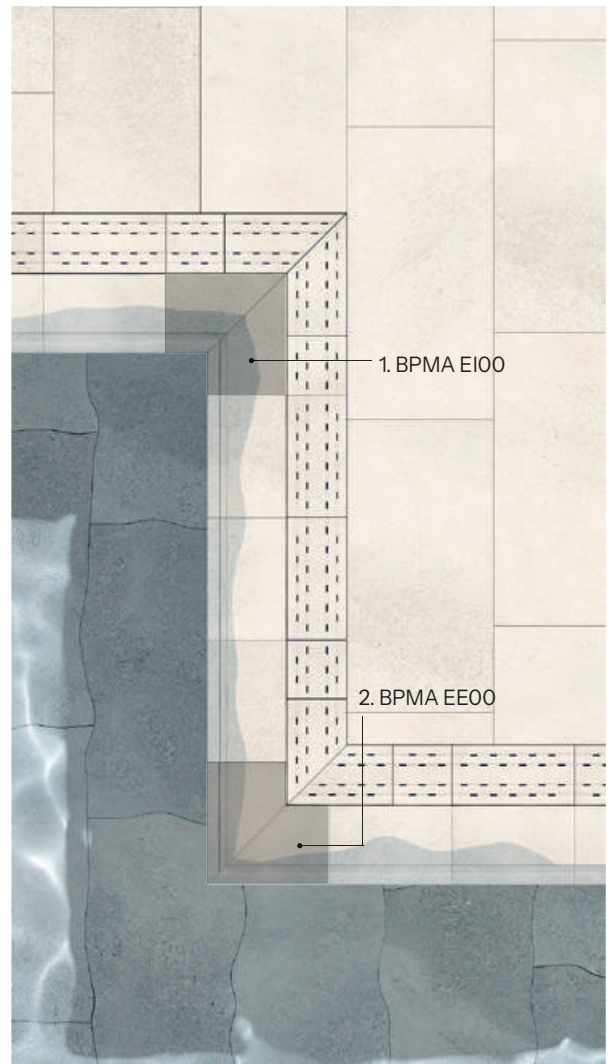

PACK ESQUINA BORDE MAUI (2 pzas)
MAUI EDGE CORNER PACK (2 pcs)

- 1. BPMA EI00 32,6 x 50 cm 12.8" x 19.7"
- 2. BPMA EE00 32,6 x 50 cm 12.8" x 19.7"

Compatible con las rejillas RJ25, RJ25 FLEX, RJ20, RJ20 FLEX y RJ25 INV
Can be used with drain grates RJ25, RJ25 FLEX, RJ20, RJ20 FLEX and RJ25 INV

INFORMACIÓN TÉCNICA | *TECHNICAL INFORMATION*

MONOBLOCK

UNA PIEZA, SIN PEGADO
ONE PIECE, WITHOUT GLUED



EN 16165
CLASE 3



EN ISO 10545-12
✓



EN 16165
R11



EN 16165
CLASE C



EN ISO 10545-13
GA / GLA / GHA



LARGA VIDA
LONG LIFE



FÁCIL LIMPIEZA
EASY CLEAN

SAMOA

BORDE DE PISCINA | POOL EDGE

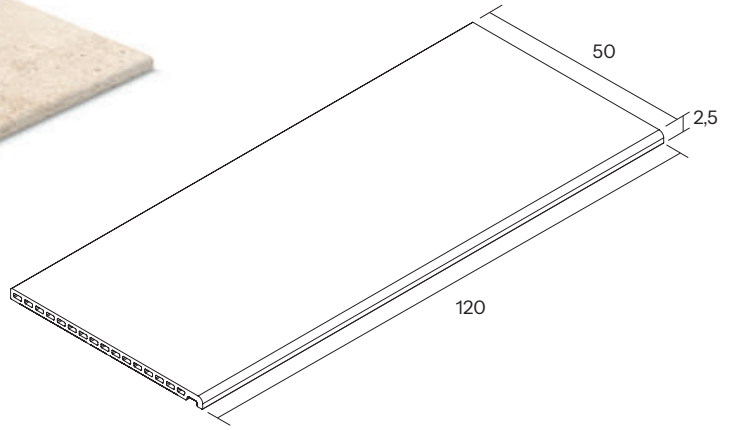

50 x 120 cm
19.7" x 47.6"

C3 R11 Ref. BPSA 0000

3 caras
3 sides

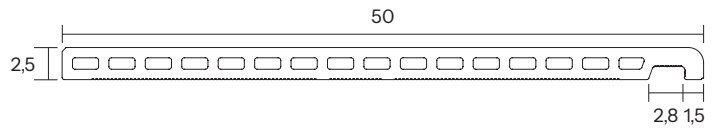

172

COLORES DISPONIBLES | AVAILABLE COLOURS

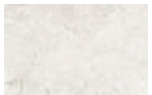

CROSSCUT
PURO

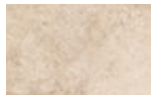

CROSSCUT
PETRA



CROSSCUT
CLOUD



SAVOY
MOON

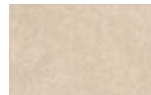

SAVOY
DESERT



SAVOY
LAND

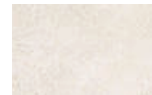

STROMBOLI
LIGHT



STROMBOLI
CREAM

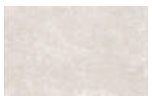

SALEM
CLAR

SOLUCIÓN CURVA | *CURVED SOLUTION*



BORDE CURVO SAMOA
SAMOA CURVED EDGE

- 1. BPSA RI00
- 2. BPSA RE00

SOLUCIÓN ESQUINA | *CORNER SOLUTION*

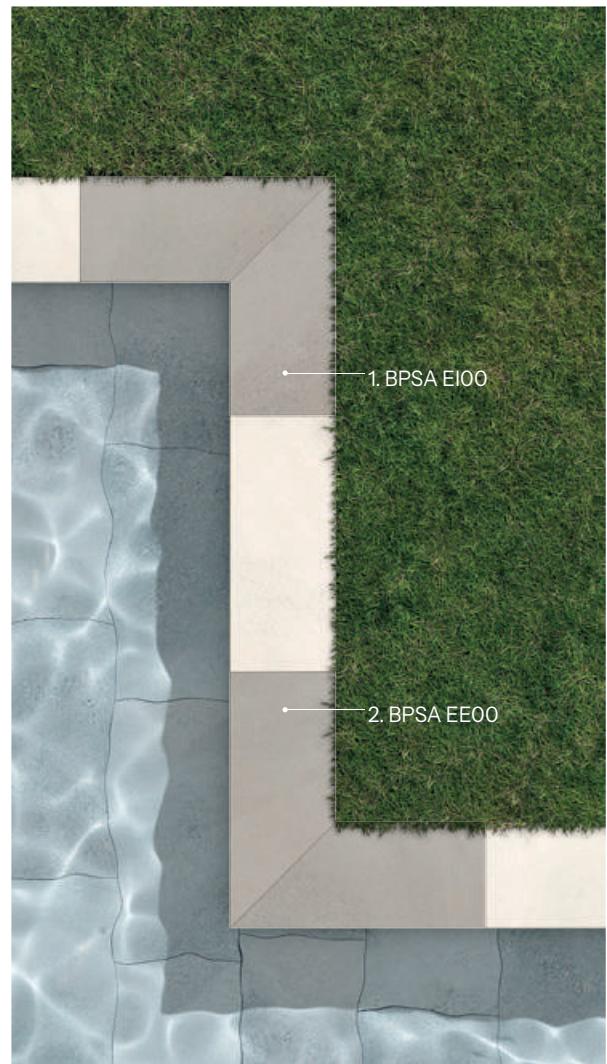

PACK ESQUINA BORDE SAMOA (2 pzas)
SAMOA EDGE CORNER PACK (2 pcs)

- 1. BPSA EI00 50 x 120 cm 19.7" x 47.6"
- 2. BPSA EE00 50 x 120 cm 19.7" x 47.6"

173

INFORMACIÓN TÉCNICA | *TECHNICAL INFORMATION*

MONOBLOCK

UNA PIEZA, SIN PEGADO
ONE PIECE, WITHOUT GLUED



EN 16165
CLASE 3



EN ISO 10545-12
✓



EN 16165
R11



EN 16165
CLASE C



EN ISO 10545-13
GA / GLA / GHA



LARGA VIDA
LONG LIFE



FÁCIL LIMPIEZA
EASY CLEAN

ARUBA

BORDE DE PISCINA | POOL EDGE

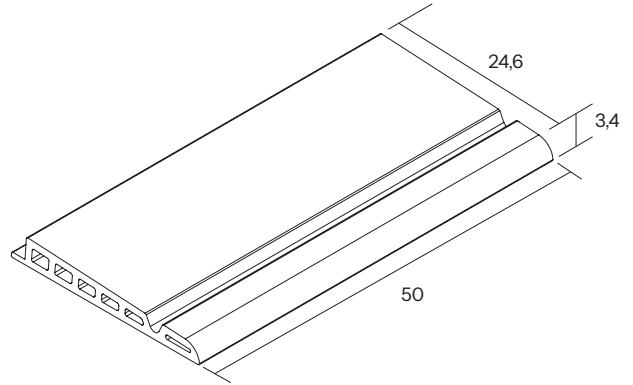

↗ ↘ 24,6 x 50 cm
9.7" x 19.7"

C3 R11 Ref. BPAR 0000

5% 

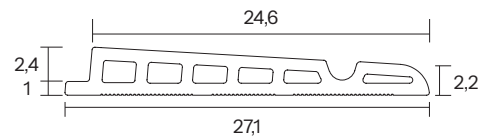

174

COLORES DISPONIBLES | AVAILABLE COLOURS



CROSSCUT
PURO

CROSSCUT
PETRA

CROSSCUT
CLOUD

STROMBOLI
LIGHT

STROMBOLI
CREAM

STROMBOLI
SILVER

SOLUCIÓN CURVA | *CURVED SOLUTION*

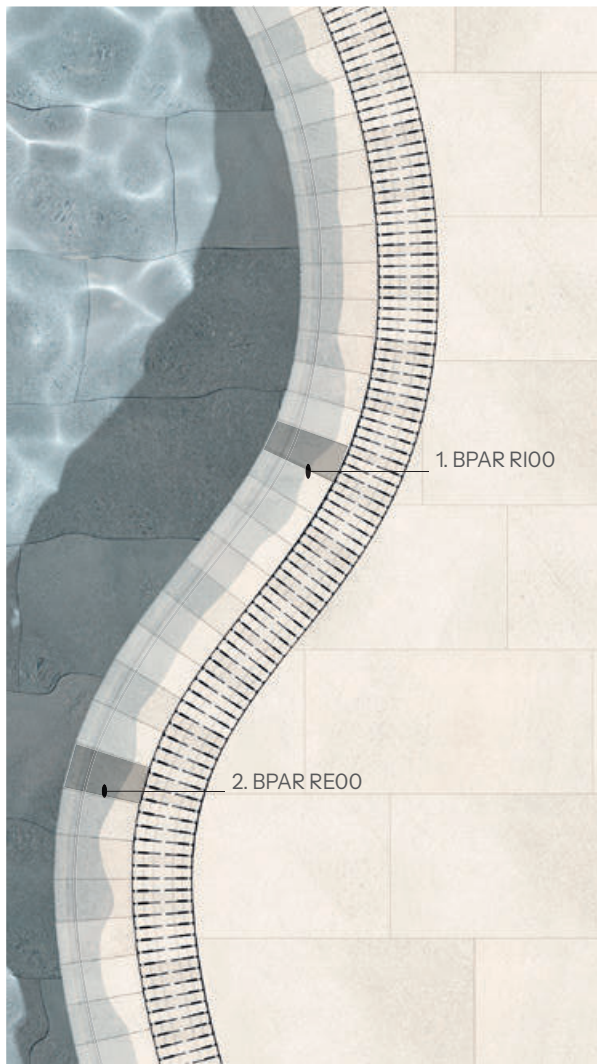

BORDE CURVO ARUBA
ARUBA CURVED EDGE

- 1. BPAR RIO0
- 2. BPAR RE00

Ambos son compatibles con las rejillas:
Both can be used with drain grates:
RJ25, RJ25 FLEX, RJ20, RJ20 FLEX, RJ25 INV

SOLUCIÓN ESQUINA | *CORNER SOLUTION*

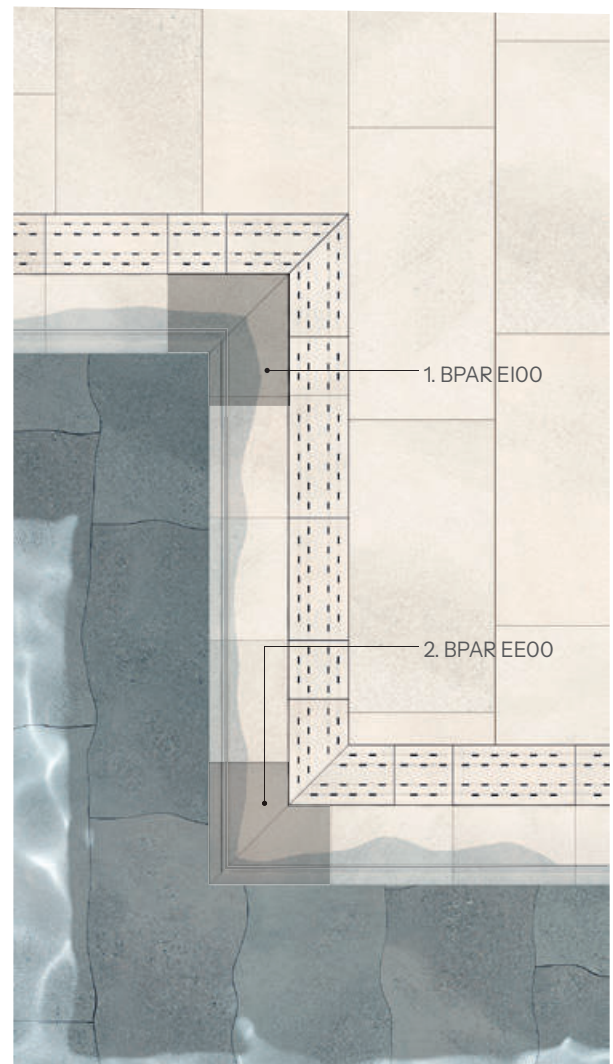

PACK ESQUINA BORDE ARUBA (2 pzas)
ARUBA EDGE CORNER PACK (2 pcs)

- 1. BPAR EI00 24,6 x 50 cm 9.6" x 19.7"
- 2. BPAR EE00 24,6 x 50 cm 9.6" x 19.7"

Ambos son compatibles con las rejillas:
Both can be used with drain grates:
RJ25, RJ25 FLEX, RJ20, RJ20 FLEX, RJ25 INV

INFORMACIÓN TÉCNICA | *TECHNICAL INFORMATION*

MONOBLOCK

UNA PIEZA, SIN PEGADO
ONE PIECE, WITHOUT GLUED



EN 16165
CLASE 3



EN ISO 10545-12
✓



EN 16165
R11



EN 16165
CLASE C



EN ISO 10545-13
GA / GLA / GHA



LARGA VIDA
LONG LIFE



FÁCIL LIMPIEZA
EASY CLEAN

RJ25

REJILLA DE DRENAJE CERÁMICA | CERAMIC DRAIN GRATES

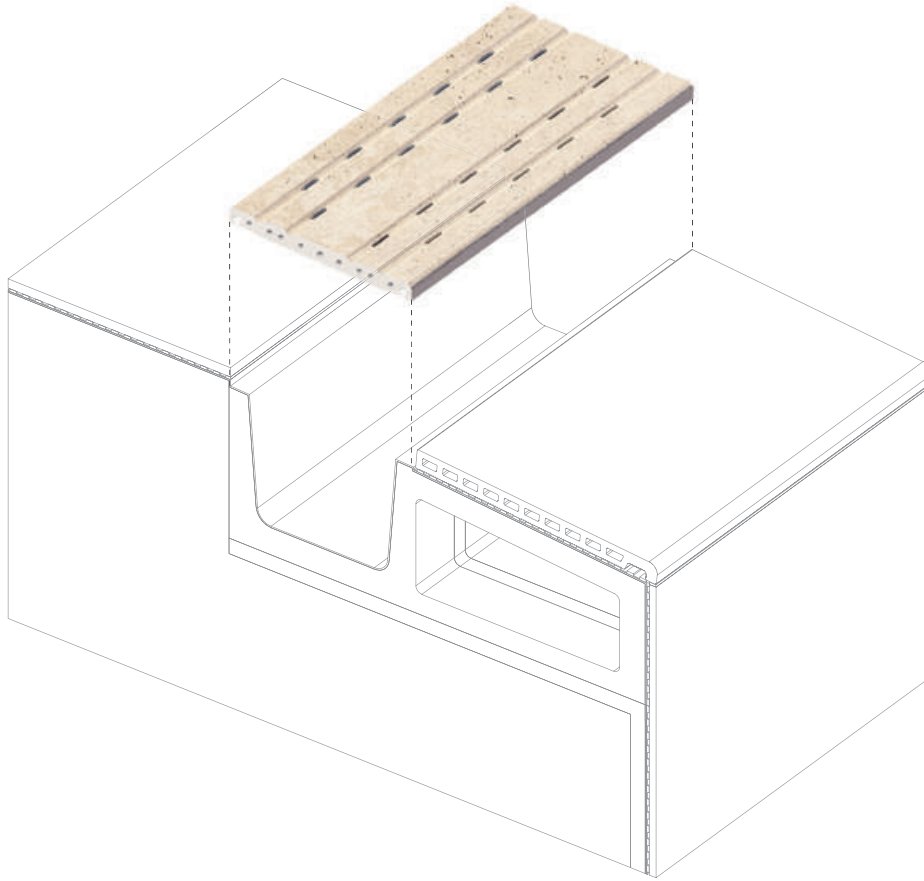

176

COLORES DISPONIBLES | AVAILABLE COLOURS



INFORMACIÓN TÉCNICA | TECHNICAL INFORMATION

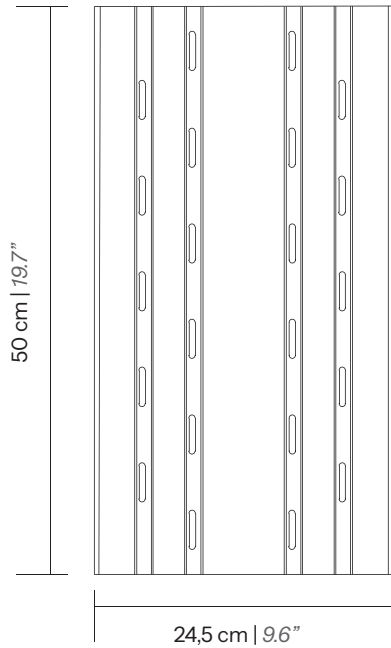

Rejilla
Grate

Ref. RJ25 0000

↗ ↙ 24,5 x 50 cm
9.6" x 19.7"



Desagüe | Drain: >13 m³ / hora

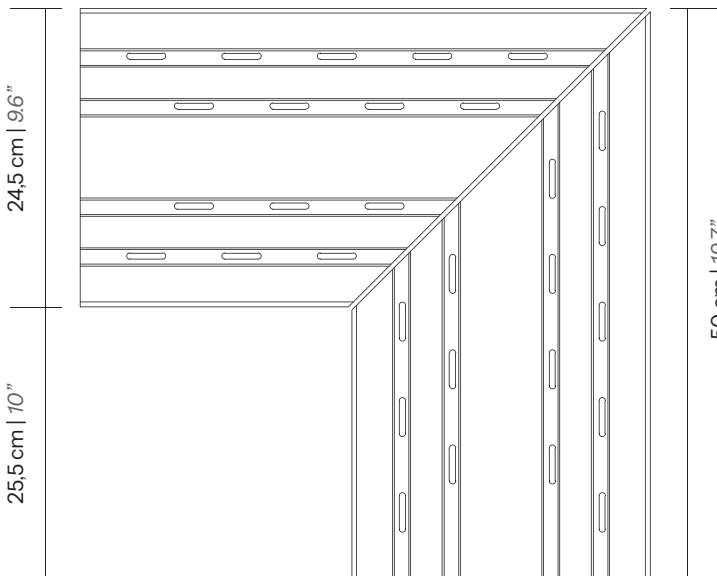
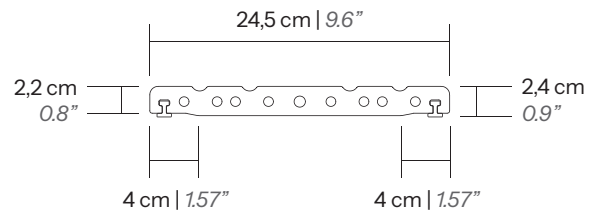

Esquina rejilla
Grate corner

Ref. RJ25 E000

↗ ↙ 24,5 x 50 cm
9.6" x 19.7"



177

GOMA AMORTIGUACIÓN | SHOCK ABSORBING RUBBER

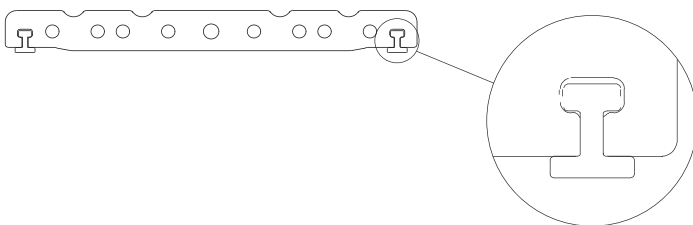

Goma para rejilla 9710 incluida
Grate rubber 9710 included

RJ25 FLEX

REJILLA DE DRENAJE CERÁMICA | CERAMIC DRAIN GRATES

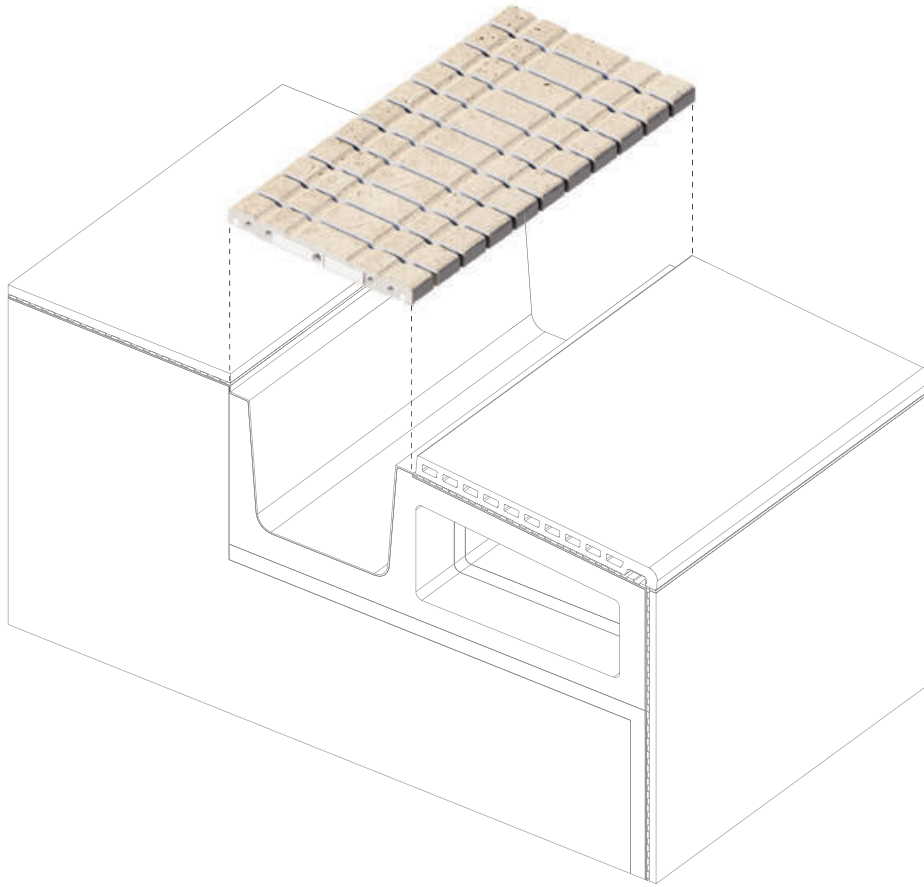

178

COLORES DISPONIBLES | AVAILABLE COLOURS



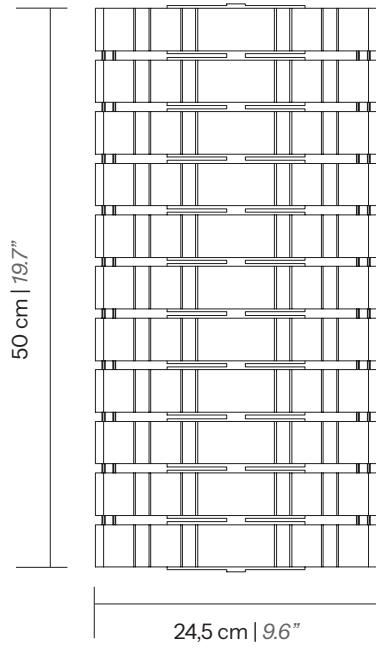

Rejilla

Grate

Ref. RJ25 FLEX

24,5 x 50 cm
9.6" x 19.7"



Desagüe | Drain: >30 m³ / hora

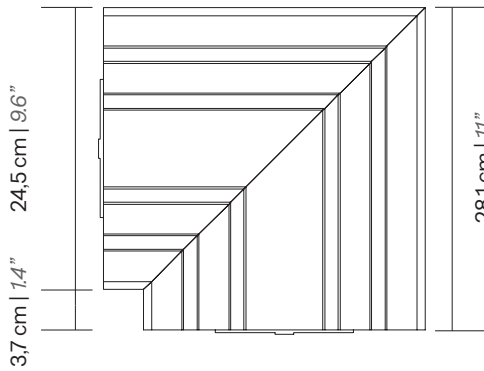
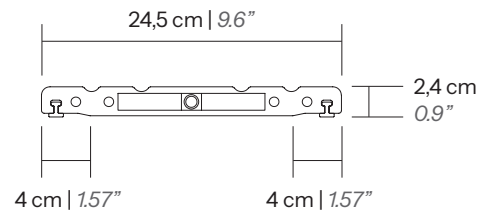

Esquina rejilla

Grate corner

Ref. RJ25 E000 FLEX

24,5 x 28 cm
9.6" x 19.7"



GOMA AMORTIGUACIÓN | SHOCK ABSORBING RUBBER

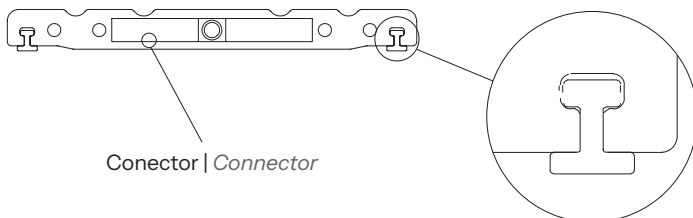

Goma para rejilla 9134 incluida
Grate rubber 9134 included

RJ25 INV

REJILLA DE DRENAJE CERÁMICA | CERAMIC DRAIN GRATES

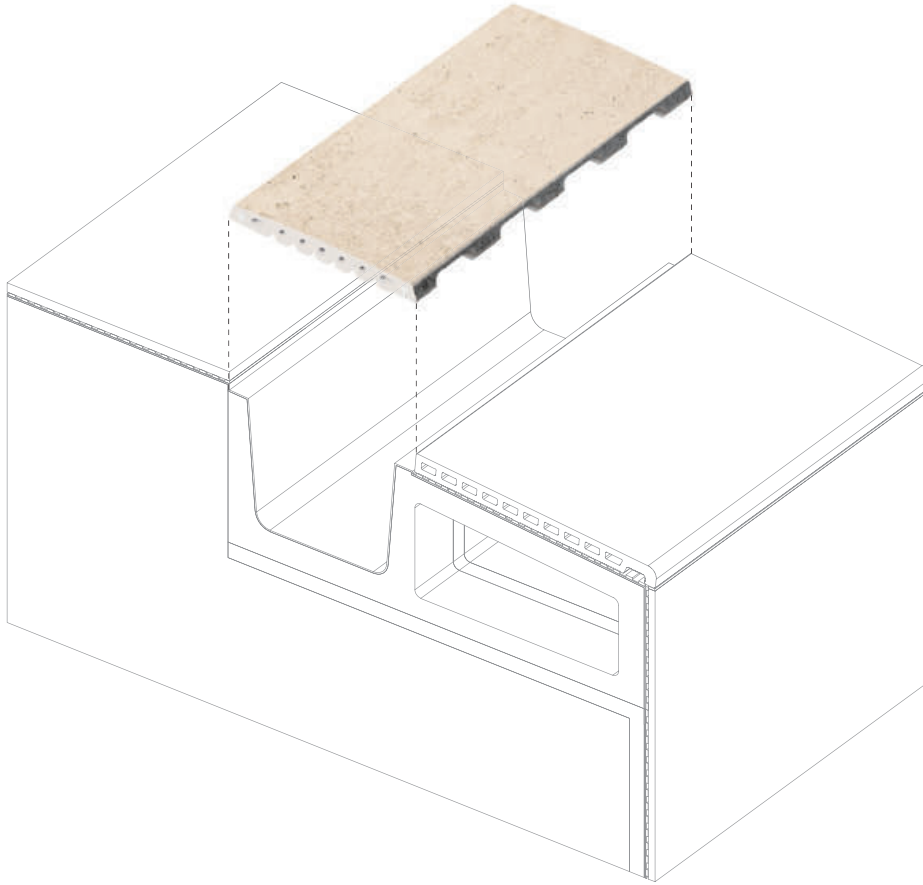

180

COLORES DISPONIBLES | AVAILABLE COLOURS



INFORMACIÓN TÉCNICA | TECHNICAL INFORMATION

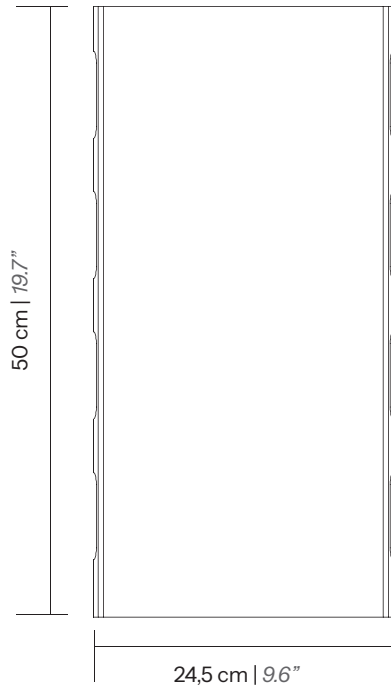

Rejilla

Grate

Ref. RJ25 0000 INV

24,5 x 50 cm
9.6" x 19.7"



Desagüe | Drain: >8 m³ / hora

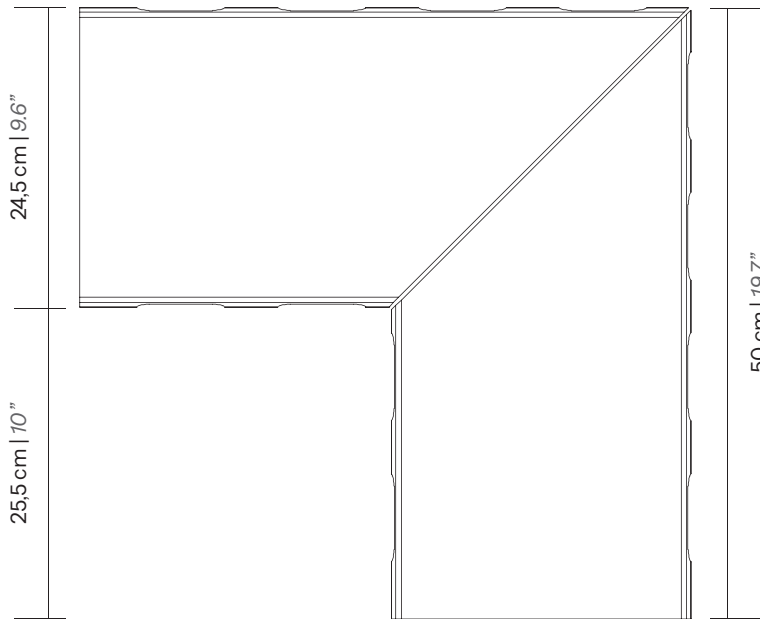
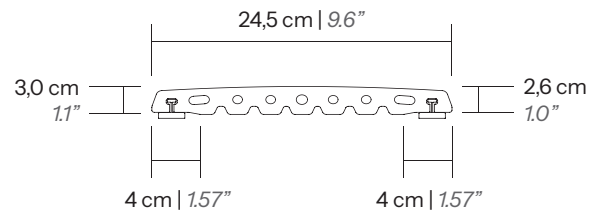

Esquina rejilla

Grate corner

Ref. RJ25 E000 INEX

24,5 x 50 cm
9.6" x 19.7"



181

GOMA AMORTIGUACIÓN | SHOCK ABSORBING RUBBER

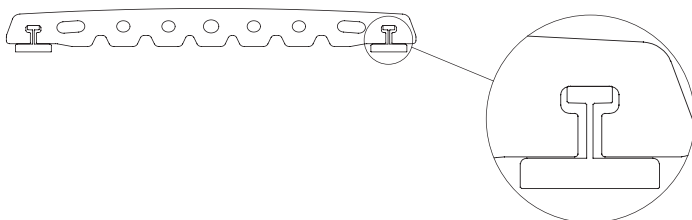

Goma para rejilla 12719 incluida
Grate rubber 12719 included

RJ20

REJILLA DE DRENAJE CERÁMICA | CERAMIC DRAIN GRATES

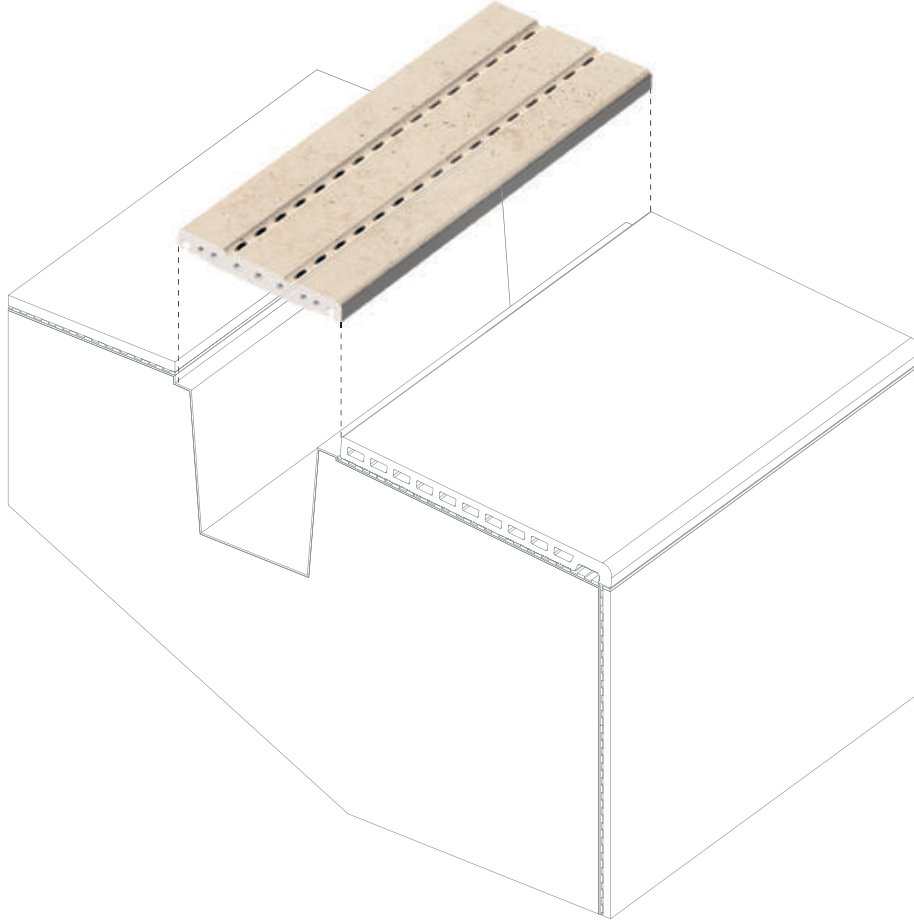

182

COLORES DISPONIBLES | AVAILABLE COLOURS

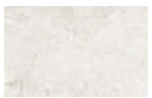

CROSSCUT
PURO

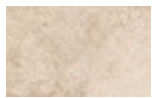

CROSSCUT
PETRA



CROSSCUT
CLOUD

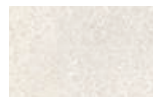

STROMBOLI
LIGHT



STROMBOLI
CREAM



STROMBOLI
SILVER



SALEM
CLAR

INFORMACIÓN TÉCNICA | TECHNICAL INFORMATION

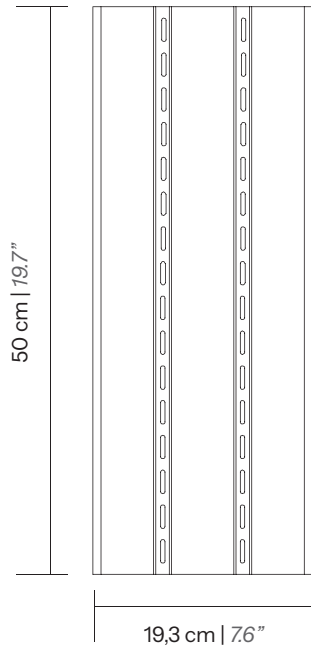

Rejilla

Grate

Ref. RJ20

19,3 x 50 cm
7.6" x 19.7"



Desagüe | Drain: >11 m³ / hora

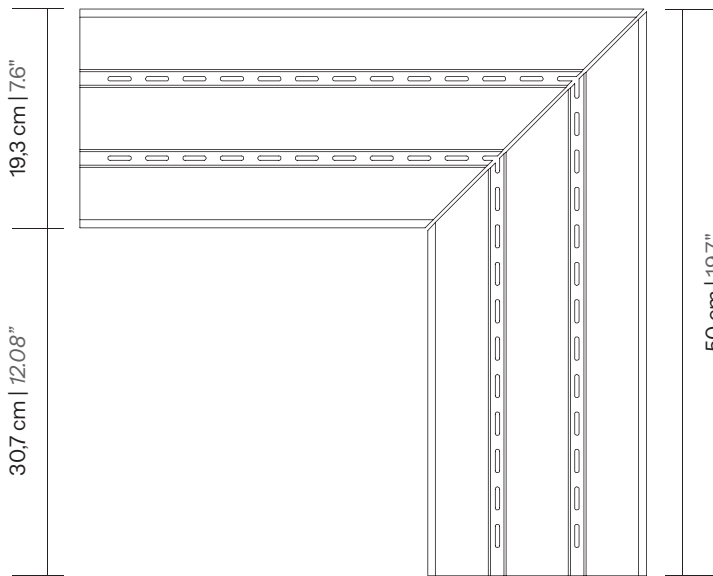
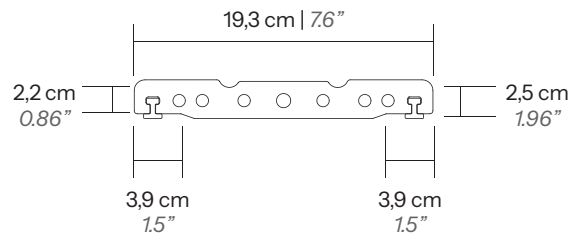

Esquina rejilla

Grate corner

Ref. RJ20 0000

19,3 x 50 cm
7.6" x 19.7"



GOMA AMORTIGUACIÓN | SHOCK ABSORBING RUBBER

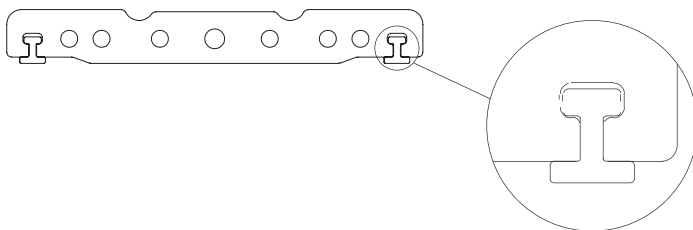

Goma para rejilla 9710 incluida
Grate rubber 9710 included

RJ20 FLEX

REJILLA DE DRENAJE CERÁMICA | CERAMIC DRAIN GRATES

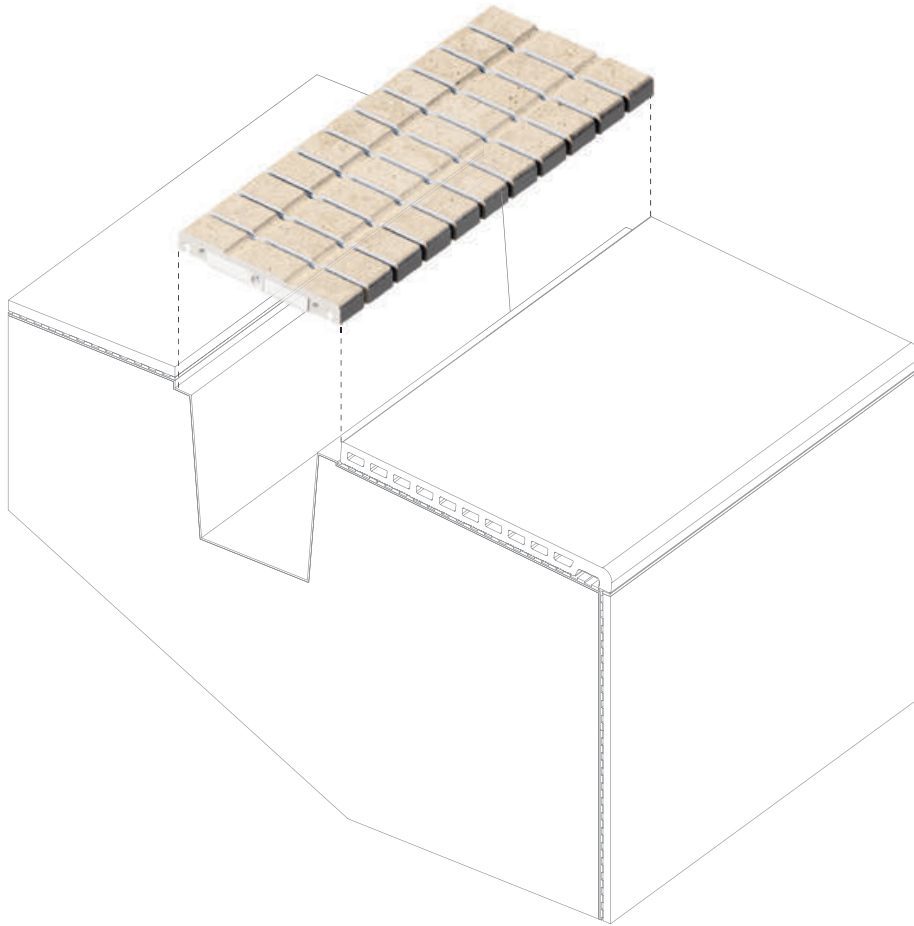

184

COLORES DISPONIBLES | AVAILABLE COLOURS



INFORMACIÓN TÉCNICA | TECHNICAL INFORMATION

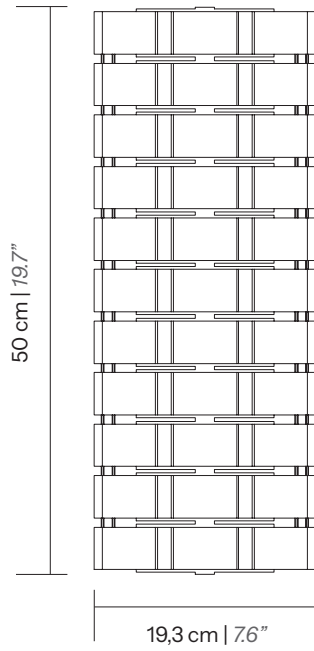

Rejilla

Grate

Ref. RJ20 FLEX

19,3 x 50 cm
7,6" x 19,7"



Desagüe | Drain: >30 m³ / hora

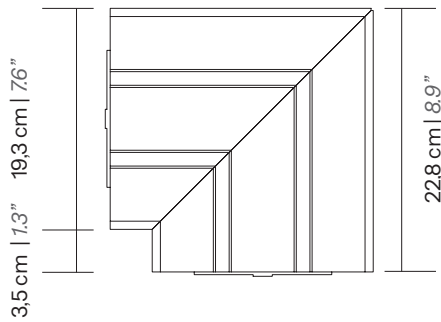
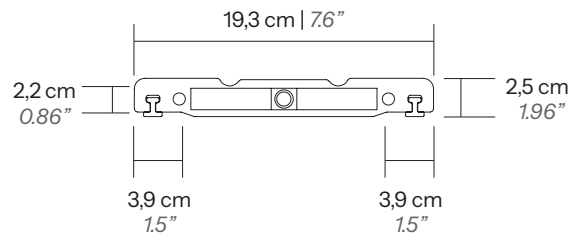

Esquina rejilla

Grate corner

Ref. RJ20 E000 FLEX

19,3 x 23 cm
7,6" x 9"



185

GOMA AMORTIGUACIÓN | SHOCK ABSORBING RUBBER

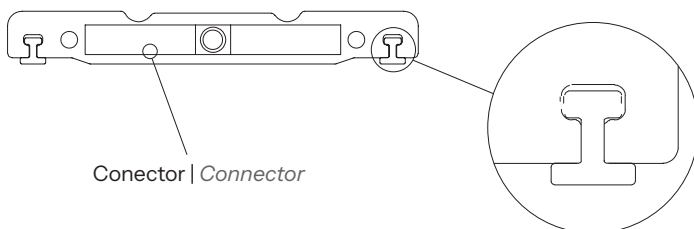

Conector | Connector



Goma para rejilla 9134 incluida
Grate rubber 9134 included

BLOCK25

SISTEMA INTEGRADO EN PISCINA DESBORDANTE | INTEGRATED INFINITY POOL SYSTEM

El sistema Block 25 de Mayor se compone de un conjunto de bloques de hormigón prefabricado cuyo objetivo principal es dejar preparada la superficie de coronación de la piscina para recibir las piezas cerámicas. Permite ejecutar con rapidez cualquier tipo de proyecto y se integra perfectamente con nuestros bordes de piscina Creta y Maui y nuestras rejillas de drenaje cerámicas de 25 cm de anchura, como lo son las RJ25 y RJ25 FLEX.

The Block 25 system by Mayor consists of a set of prefabricated water-repellent concrete blocks whose main purpose is to prepare the pool coping surface to receive the ceramic pieces.

This system allows any type of swimming pool project to be carried out quickly and Block 25 integrates perfectly with our Creta and Maui pool edges and our 25 cm wide ceramic drainage gratings, such as RJ25 and RJ25 FLEX.

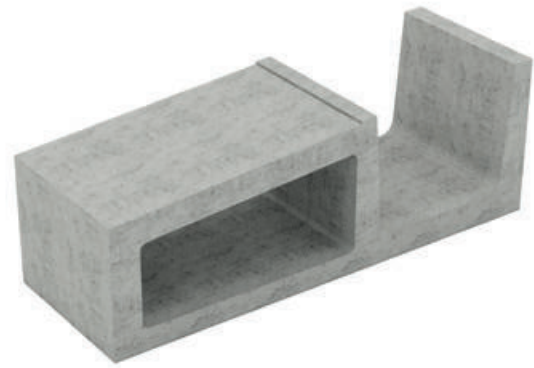

186

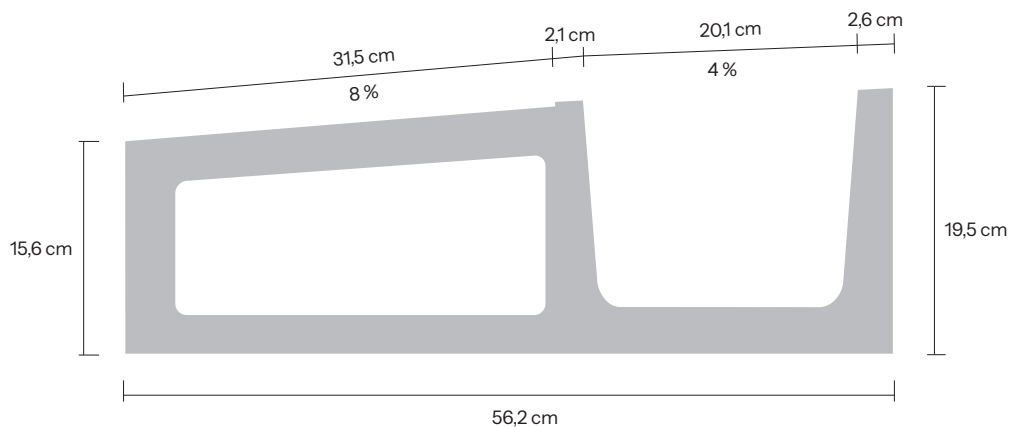

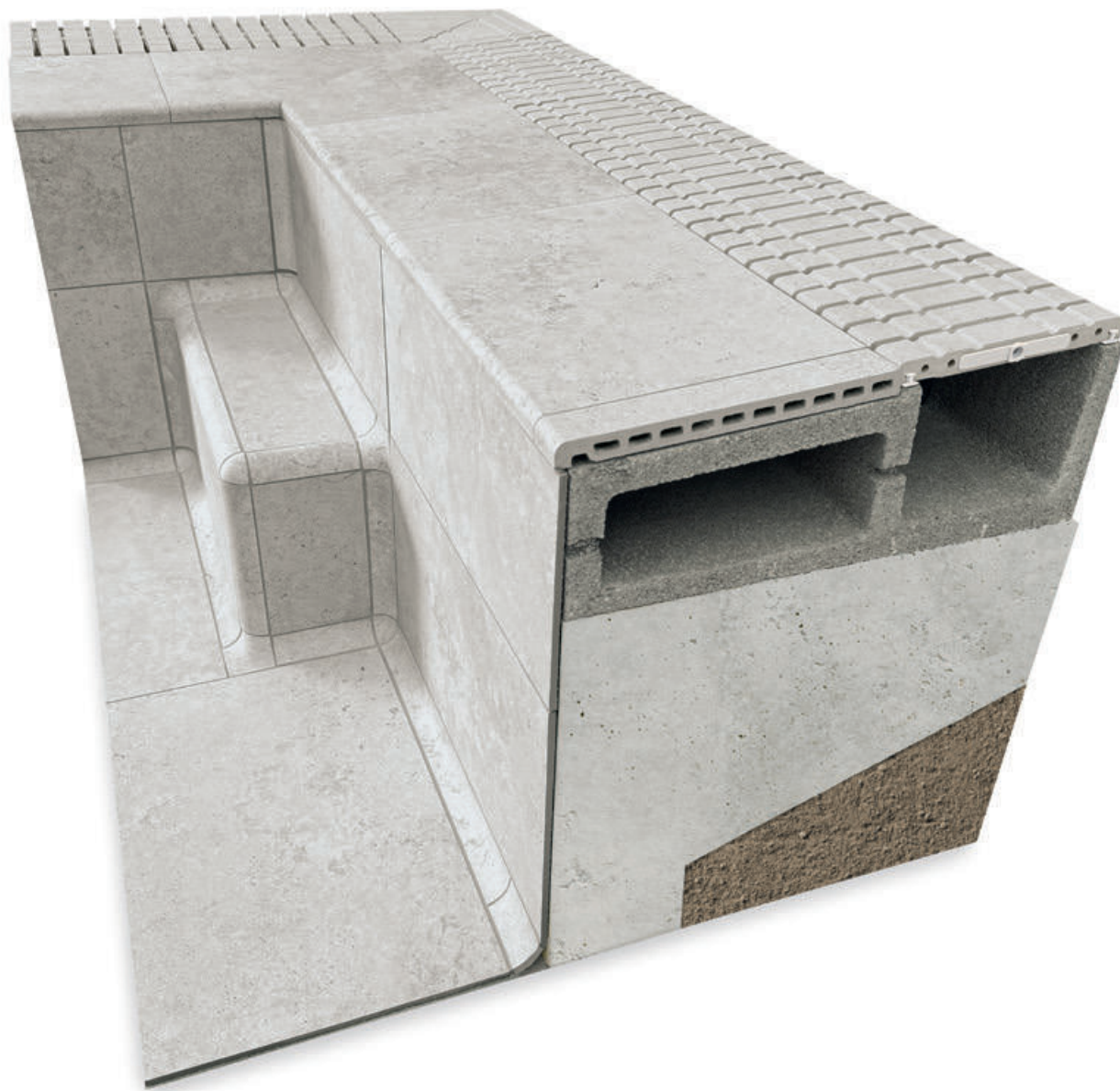

Escanea este QR y descubre las ventajas de nuestro sistema constructivo de colocación.
Scan this QR and discover the advantages of our constructive installation system.

MONTAJE
ASSEMBLY

Los bloques de hormigón para canales de piscinas son una solución práctica, resistente y eficiente, con múltiples ventajas.

—
Concrete blocks for swimming pool channels are a practical, resistant and efficient solution with many advantages.

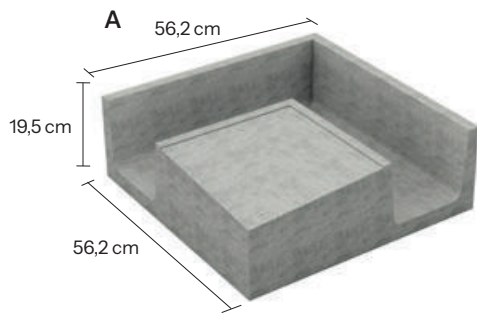
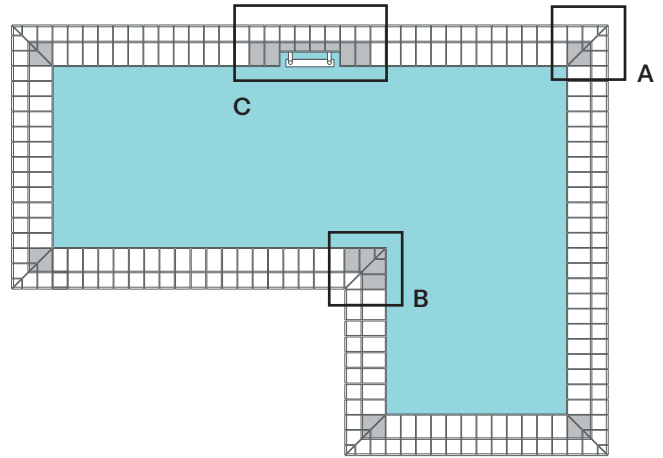

ESQUINA INTERIOR
SISTEMA BLOCK EI 25
Ref. 13114

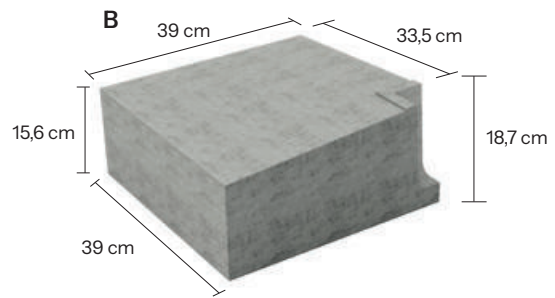

ESQUINA EXTERIOR
SISTEMA BLOCK EE 25
Ref. 13113

C

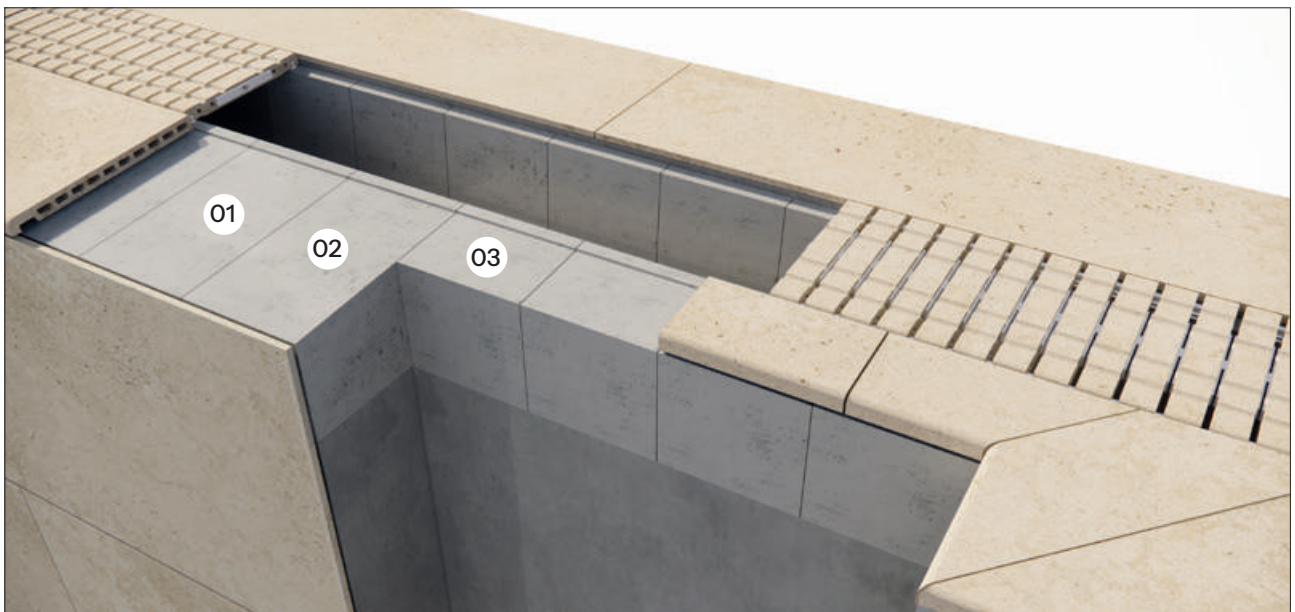

Ubicación de los diferentes tipos de bloque en zona de acceso
Location of the different block types in access area

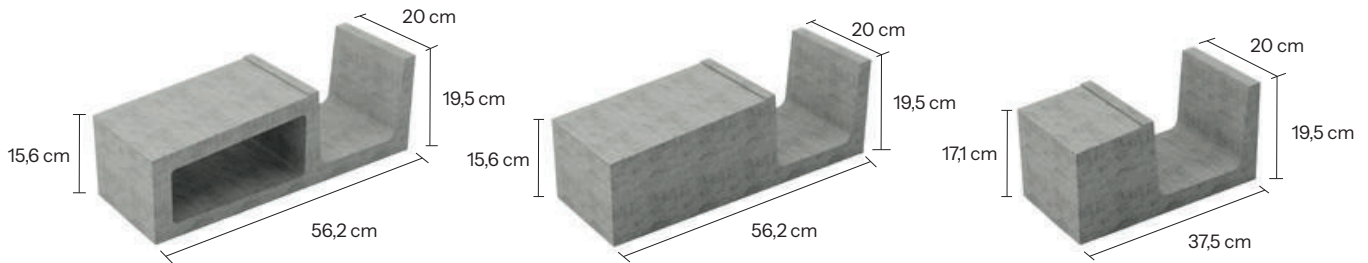

01. SISTEMA BLOCK 25
Ref. 13064

02. SISTEMA BLOCK 25 MACIZO
Ref. 13208

03. SISTEMA BLOCK 25
MEDIO MACIZO
Ref. 13209



FACILIDAD DE INSTALACIÓN
EASE OF INSTALLATION

Su diseño permite colocarlos rápidamente y con precisión, optimizando tiempos y logrando un acabado uniforme.

—
Their design allows them to be fitted quickly and accurately, optimising time and achieving a uniform finish.



ALTA RESISTENCIA
HIGH RESISTANCE

Ideales para entornos de piscinas, resisten humedad, temperaturas extremas y desgaste.

—
Ideal for swimming pool environments, they resist moisture, extreme temperatures and wear and tear.

189



AHORRO DE TIEMPO Y COSTOS
TIME AND COST SAVINGS

Combinan funcionalidad y facilidad de instalación, reduciendo esfuerzos y costos en la obra.

—
They combine functionality and ease of installation, reducing efforts and costs on site.



BASE ESTABLE PARA CERÁMICA
STABLE BASE FOR CERAMICS

Ofrecen una superficie plana que facilita la instalación de piezas cerámicas, garantizando durabilidad y estética.

—
They offer a flat surface that facilitates the installation of ceramic tiles, guaranteeing durability and aesthetics.



COMPATIBILIDAD PERFECTA
PERFECT COMPATIBILITY

Se integra sin problemas con nuestros bordes de piscina y rejillas de 25 cm de ancho. Asegura un drenaje eficiente y una estética armoniosa en todo el perímetro de la piscina.

—
It integrates seamlessly with our pool edges and 25 cm wide drain grates. Ensures efficient drainage and harmonious aesthetics around the pool perimeter.

*Información detallada sobre la instalación del sistema Block25 para piscinas en las páginas 224 y 225.

*Detailed information about installation of Block25 system for pools in pages 224 and 225.

MEDIAS CAÑAS

PIEZAS DE TERMINACIÓN | TRIMS

1. Media caña exterior | *Outer trims*

4,5 x 50 cm
1,8" x 19,7"

Ref. MDCA E000

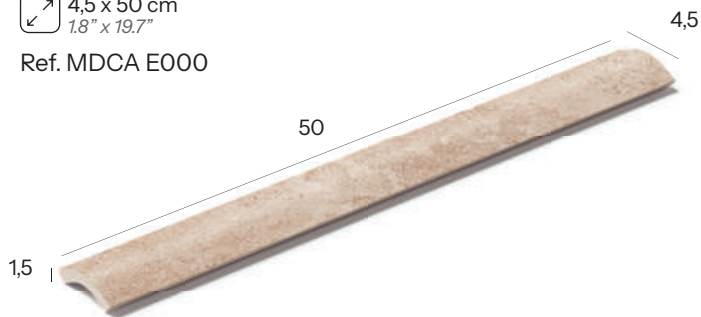

3. Escocia cantonera exterior | *Covemolding outer corner*

4,5 x 4,5 cm
1,8" x 1,8"

Ref. MDCA EE00



5. Esquina cantonera exterior | *Outer angle corner*

6,5 x 6,5 cm
2,6" x 2,6"

Ref. MDCA AE00



7. Cantonera transición exterior | *External transition corner*

4,5 x 25 cm
1,8" x 9,8"

Ref. MDCA CE00

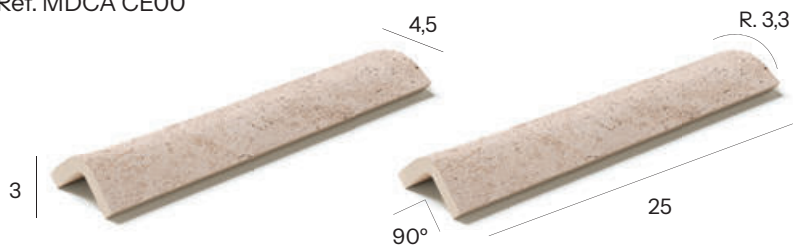

2. Media caña interior | *Inner trims*

5,5 x 50 cm
2.2" x 19.7"

Ref. MDCA I000

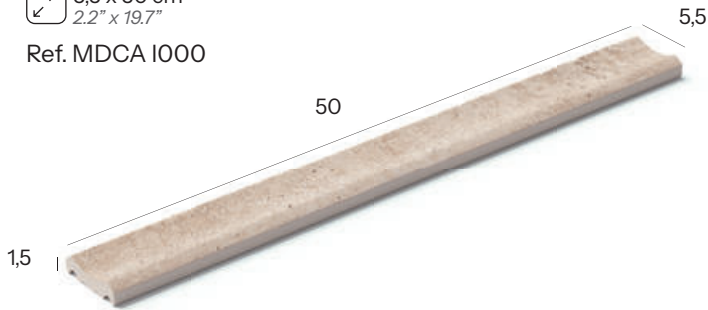

4. Escocia cantonera interior | *Covemolding inner corner*

5,5 x 5,5 cm
2.2" x 2.2"

Ref. MDCA EI00

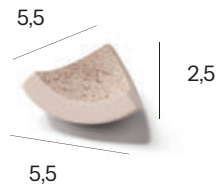

6. Esquina cantonera interior | *Inner angle corner*

6,5 x 6,5 cm
2.6" x 2.6"

Ref. MDCA AI00

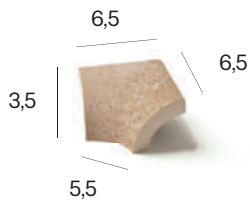

8. Cantonera transición interior | *Inner transition corner*

5,5 x 25 cm
2.2" x 9.8"

Ref. MDCA CI00

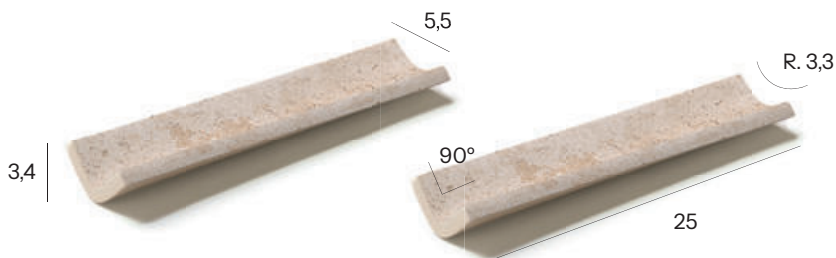



COLORES DISPONIBLES | AVAILABLE COLOURS

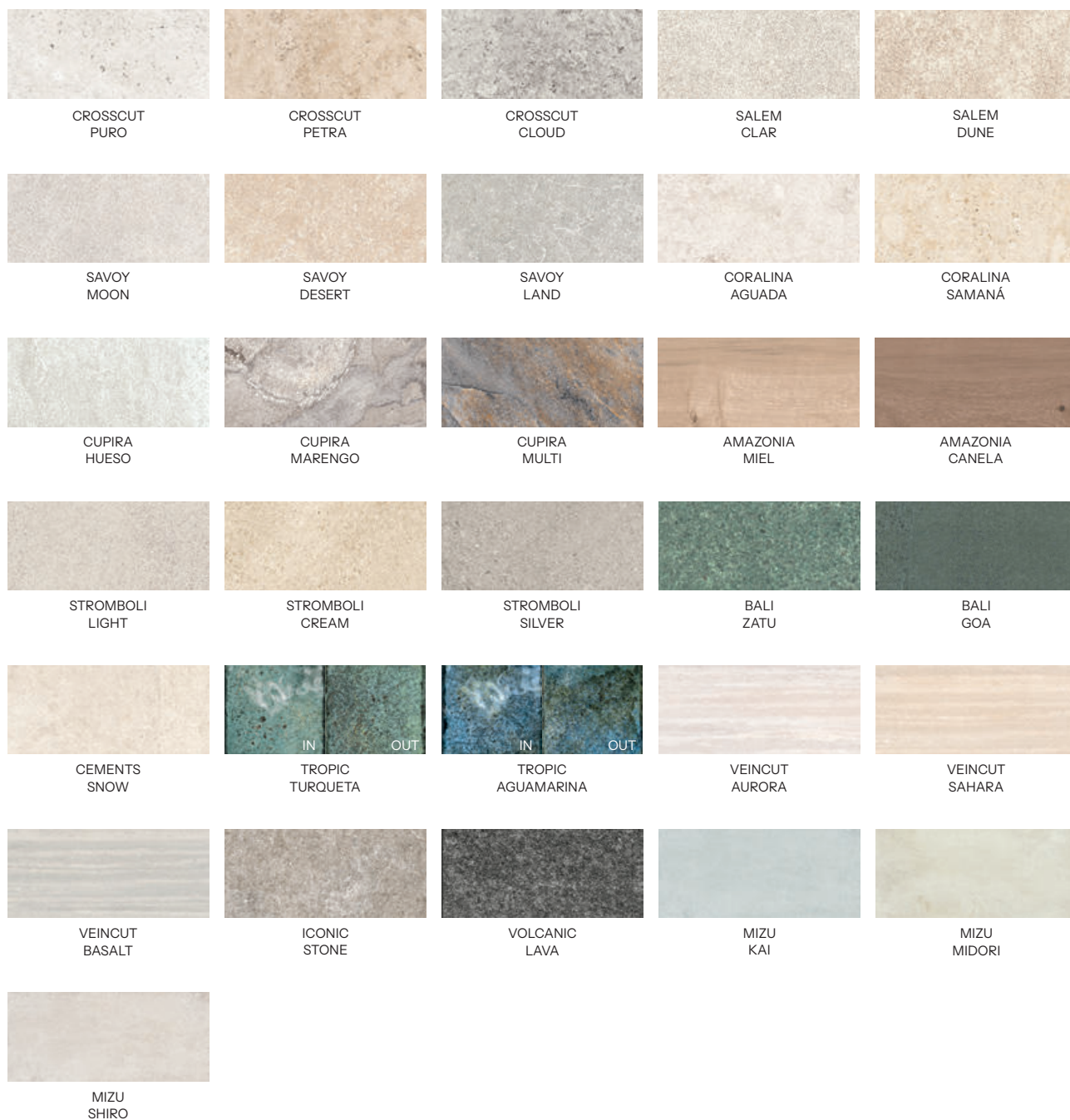

Escanea este QR y visualiza nuestro video de colocación de medias cañas.
Scan this QR and watch our trims installation video.



SISTEMAS CONSTRUCTIVOS DE PISCINAS

Pool Construction Systems

Colecciones
Collections

Piezas especiales
Special pieces

Sistemas constructivos piscinas
Pool construction systems

Colocación pavimento
Flooring installation

Colocación peldaños
Steps installation

Colocación piezas
especiales piscinas
*Installation of special
pool components*

«Nuestra experiencia
une técnica y diseño para crear
soluciones funcionales y con carácter».

*«Our experience combines
technique and design to create
functional solutions with character».*

Este es uno de los sistemas que mayor continuidad consigue y se ha convertido en un diseño de piscina distintivo y visualmente atractivo que permite que el agua desbordante sea recirculada eficientemente a través de las rejillas de drenaje con canaleta que bordean el vaso. Son modernas y elegantes consiguiendo la integración en el entorno.

This is one of the systems that achieves the greatest continuity and has become a distinctive and visually appealing pool design that allows overflowing water to be efficiently recirculated through the gutter drainage grilles that line the pool. They are modern and elegant, blending into their surroundings.

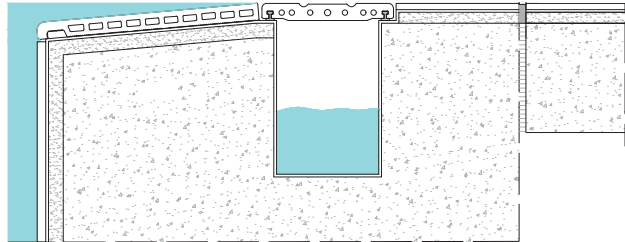

BPCR + RJ20

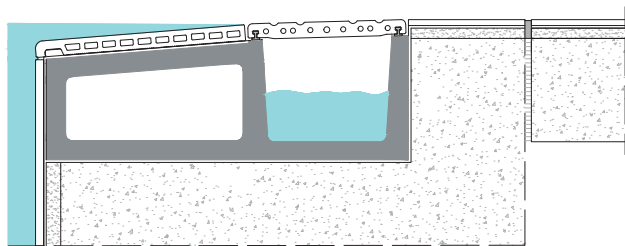

BLOCK 25: BPCR + RJ25





**CORONACIÓN CON BORDE
DESbordANTE Y REJILLA DE DRENAJE**
*POOL COPING WITH OVERFLOW EDGES
AND DRAIN GRATES*

Mayor ofrece 3 tipos de borde desbordante: Creta, Maui y Aruba, todos combinables con los 5 tipos de rejillas: RJ20, RJ20 FLEX, RJ25, RJ25 FLEX y RJ25 INV.

—
Mayor offers 3 types of overflow edges: Creta, Maui and Aruba, all combinable with the 5 types of drain grates: RJ20, RJ20 FLEX, RJ25, RJ25 FLEX and RJ25 INV.



Haciendo desaparecer el borde en el horizonte con su efecto "sin fin", las piscinas infinity se distinguen debido a su perfecta integración en el paisaje. Estas piscinas de gres porcelánico guían el flujo del agua hacia el canal situado en la zona infinity manteniendo la calidad del agua y el constante desbordamiento de esta.

Making the edge disappear into the horizon with its 'endless' effect, infinity pools are distinguished by their perfect integration into the surrounding landscape. These porcelain stoneware pools guide the flow of water into the channel located in the infinity zone while maintaining the quality of the water and the constant overflow of the water.

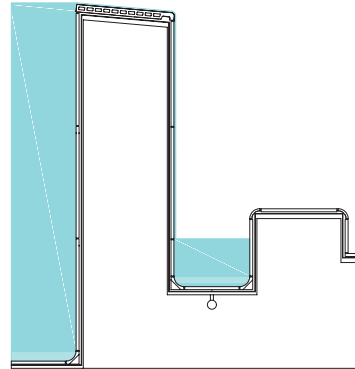

Coronación con Borde Creta
Creta edge pool coping

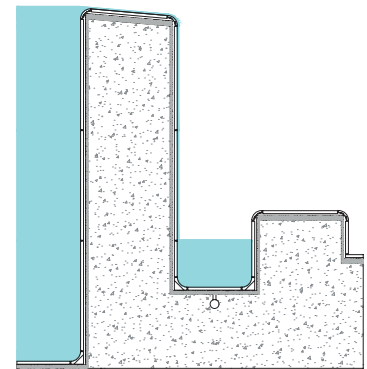

Coronación con Medias Cañas
Trims pool coping





CORONACIÓN CON MEDIAS CAÑAS

TRIMS POOL COPING

Actualmente Mayor ofrece dos tipos de coronación para piscina infinity y las medias cañas son una de ellas, pudiéndose colocar en la zona desbordante ofreciendo un acabado continuo generado por las piezas MDCA 1000 y MDCA E000.

—
Mayor currently offers two types of coping for infinity pools and trims are one of them, which can be placed in the overflow area offering a continuous finish created using the MDCA 1000 and MDCA E000 pieces.

CORONACIÓN CON BORDE CRETA

POOL COPING WITH CRETA EDGE

La segunda forma de crear el efecto "sin fin" en la piscina es utilizando el borde Creta en la zona de la coronación y desbordamiento de la piscina, empleando así una única pieza para dar solución de manera sencilla a este tipo de piscinas.

—
The second way to create the "endless" effect is to use the Creta edge in the pool coping and its overflow area, thus using a single piece to provide a simple solution for this type of pool.

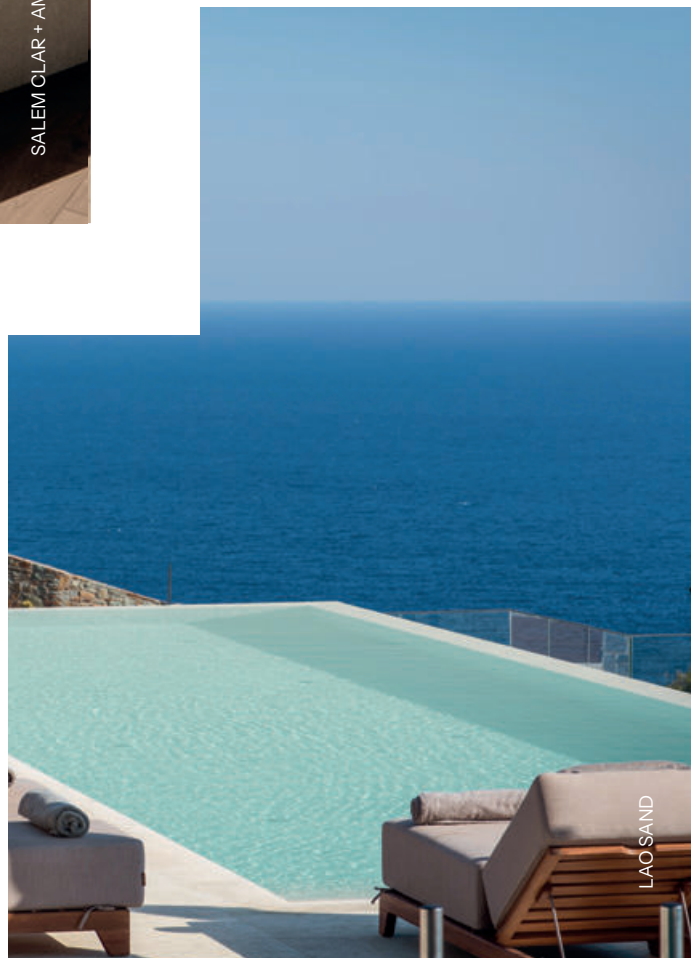

Las piscinas skimmer se mantienen atemporales, siendo el estilo más clásico de los tres. Gracias a su sistema de filtrado, recoge el agua y elimina los residuos que flotan en la superficie manteniéndola libre de impurezas. Además, mantiene la integración entre el interior y el exterior de la piscina pudiéndose utilizar el mismo color para ambos.

Skimmer pools remain timeless, being the most classic of the three styles. Thanks to its filtering system, the skimmer collects the water and eliminates the waste that floats on the surface, keeping it free of impurities. In addition, it maintains the integration between the interior of the pool and the exterior, and the same colour can be used for both.

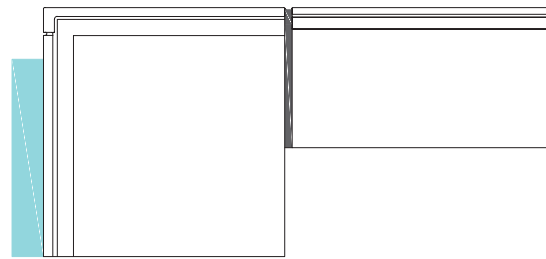

Coronación peldaño
Step pool coping

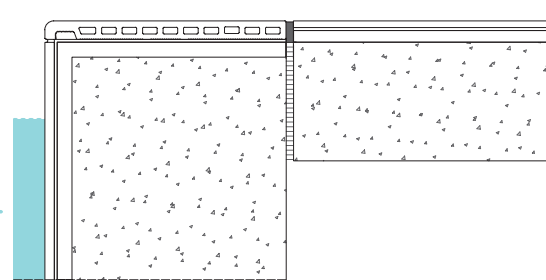

Coronación con borde Creta
Creta edge pool coping





CORONACIÓN CON PELDAÑO

POOL COPING WITH RECTO STEP

Otra de las maneras para coronar una piscina skimmer es con la pieza de peldaño recto cuya geometría permite resolver el ángulo recto generado entre la terraza y la piscina, permitiendo crear piscinas de aspecto moderno y minimalista.

—
Another way for coping a skimmer pool is with the straight step whose geometry allows to solve the right angle generated between the terrace and the pool, allowing to create pools with a modern and minimalist look.

CORONACIÓN CON BORDE DE PISCINA

POOL COPING WITH POOL EDGE

Aunque es uno de los sistemas más clásicos, el sistema skimmer se mantiene atemporal. Mayor ha creado dos soluciones idóneas para su coronación, los bordes Creta y Samoa, tanto para piscinas reformadas como de nueva obra.

—
Although it is one of the most classic systems, the skimmer system remains timeless. Mayor has created two ideal coping solutions: the Creta and Samoa edges, for both refurbished and newly built pools.



El gres porcelánico es el material perfecto para el revestimiento interior de una piscina por su resistencia, versatilidad y durabilidad. Permite integrar distintas soluciones que añaden valor al proyecto y mejoran la funcionalidad y la estética. Una de estas soluciones técnicas son las medias cañas, que permiten la continuidad visual, el acabado antideslizante, la seguridad y la correcta limpieza en el interior de la piscina.

Porcelain tile is the perfect material for the interior lining of a swimming pool due to its resistance, versatility and durability. It allows the integration of different solutions that add value to the project and improve functionality and aesthetics. One of these technical solutions are trims, which allow for visual continuity, a non-slip finish, safety and proper cleaning inside the pool.

«Las medias cañas añaden valor al proyecto y mejoran la funcionalidad y la estética».

«The trims add value to the project and improve functionality and aesthetics».





**SOLUCIÓN CON MEDIAS CAÑAS PARA
EL INTERIOR DEL VASO DE LA PISCINA**
*SOLUTION WITH TRIMS FOR THE INSIDE
OF THE POOL BASIN*

Mayor ofrece ocho tipos distintos de piezas especiales de media caña para el revestimiento interior de la piscina, evitando así los ángulos rectos y ofreciendo la continuidad deseada en el mismo color que el resto de la piscina.

—
Mayor offers eight different types of trims for the interior lining of the pool, avoiding right angles and providing the desired visual continuity in the same colour as the rest of the pool.



COLOCACIÓN DEL PAVIMENTO

Flooring Installation

Colecciones
Collections

Piezas especiales
Special pieces

Sistemas constructivos piscinas
Pool construction systems

Colocación pavimento
Flooring installation

Colocación peldaños
Steps installation

Colocación piezas
especiales piscinas
*Installation of special
pool components*

«Buscamos la máxima calidad técnica y estética pero también emocional para crear espacios donde apetece quedarse».

«We strive for the highest technical and aesthetic quality, but also emotional quality, to create spaces where you want to stay».

AVISO IMPORTANTE ANTES DE LA PUESTA EN OBRA:

IMPORTANT BEFORE STARTING INSTALLATION, PLEASE NOTE THE FOLLOWING:

01. Verificar que el material recibido se corresponde con el material solicitado por el cliente.

Verify that the received material is what the customer ordered

02. Verificar la ausencia de defectos visibles (baldosas de 1ª calidad).

Ensure that there are no important physical defects (in 1st quality material).

03. Las piezas especiales, debido a su forma y función, pueden presentar geometrías más complejas que las baldosas planas, lo que influye en su proceso de fabricación y puede ocasionar ligeras variaciones cromáticas respecto a estas. Por ello, se recomienda realizar una prueba de colocación preliminar – utilizando piezas de distintas cajas y formatos – con el fin de evaluar la armonía visual del conjunto antes de proceder con la instalación definitiva del producto.

Due to their specific shapes and functions, special pieces may exhibit more complex geometries than standard flat tiles. These variations can impact the manufacturing process, potentially resulting in slight chromatic differences compared to flat tiles. It is therefore strongly advised to perform a preliminary dry installation – selecting pieces from multiple boxes and formats– to evaluate the visual consistency and integration of the overall layout prior to final installation.

04. Se recomienda, al colocar, mezclar piezas de varias cajas.

It is recommended to mix pieces from several boxes when setting.

05. No se admitirán reclamaciones de problemas derivados del incumplimiento de estas premisas cuando el material ya esté colocado.

Claims will not be accepted when the above conditions have not been fulfilled and the material has been installed.

PARA CUALQUIER RECLAMACIÓN ES NECESARIA LA REFERENCIA DE LA CAJA.

THE BOX REFERENCE WILL BE NECESSARY FOR ANY CLAIM.

PREPARACIÓN DE LOS MATERIALES

PREPARATION OF MATERIALS

- Cemento de agarre. *Grip cement.*
- Nivel manual y elementos de medición necesarios. *Spirit level and measuring elements.*
- Cuñas de nivelación. *Levelling wedges.*
- Crucetas. *Auto-levelling spacers.*
- Pasta de rejunte. *Grouting material.*
- Paleta. *Trowel.*
- Llana dentada. *Serrated trowel.*
- Productos de limpieza. *Cleaning products.*

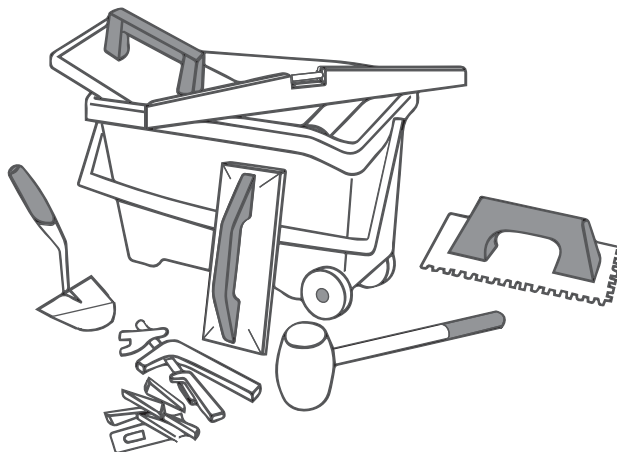

COMPROBAR LA CORRECTA NIVELACIÓN DEL SOPORTE

CHECK THE CORRECT LEVELLING OF THE SUPPORT

En terrazas y espacios exteriores es muy importante evacuar el agua correctamente para evitar que ésta quede estancada en la superficie.

—
On terraces and outdoor spaces it is very important to drain water correctly to prevent it from stagnating on the surface.

MAYOR RECOMIENDA LO SIGUIENTE:

MAYOR RECOMMENDS THE FOLLOWING:

- Imprescindible dar una pendiente mínima que esté comprendida entre el 1-3%.
It is essential to provide a minimum slope of between 1-3%.
- Se deberán colocar los suficientes canales sumideros para que no existan problemas de evacuación de aguas pluviales. *Sufficient drainage channels should be installed to avoid rainwater drainage problems.*
- El terreno tendrá que estar correctamente impermeabilizado y drenado para evitar el ascenso del agua por capilaridad. *The ground must be properly waterproofed and drained to prevent water rising by capillary action.*
- Se deberá de utilizar mortero de nivelación, también conocido como autonivelante con el fin de obtener un soporte sólido preparado para recibir las piezas de gres porcelánico. *Levelling mortar or also known as self-levelling mortar must be used to achieve a solid substrate ready to receive the stoneware tiles.*

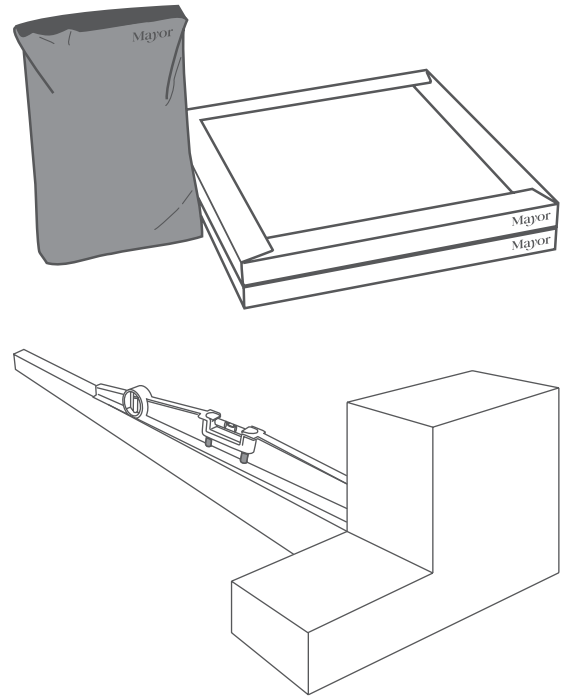

207

LIMPIEZA DE LA SUPERFICIE

SURFACE CLEANLINESS

Se deberá de comprobar que la superficie esté exenta de restos de otros materiales tales como residuos de cemento, grasas, polvo, etc.

The surface must be checked to ensure that it is free of other materials such as cement residues, grease, dust, etc.



REPLANTEO DE LA SUPERFICIE

LAYING OUT THE SURFACE

Con el fin de aprovechar al máximo el material cerámico se deberá de establecer una línea principal a partir de la cual se iniciará la colocación.

—
In order to avoid the wastage of material, a main line should be established from which the tile installation will begin.

EN EL REPLANTEO SE TENDRÁN QUE TENER EN CUENTA:

IN THE LAYOUT, THE FOLLOWING MUST BE TAKEN INTO ACCOUNT:

- Juntas perimetrales: Tendrá que ser > 5,00 mm. *Perimeter joints: These should be > 5.00 mm.*
- Juntas estructurales: Deberán de coincidir con las juntas estructurales del edificio y serán como mínimo de 10 mm y tendrán que ser de un material flexible. *Structural joints: These shall coincide with the structural joints of the building and shall be at least 10 mm and be made of a flexible material.*
- Junta de partición: En áreas entre 20-30 m² o 6-8 ml se requerirá de una junta de partición de > 5,00 mm. *Partition joint: In areas between 20-30 m² or 6-8 ml a partition joint of > 5.00 mm will be required.*
- Juntas de colocación: Para la colocación de Material Rectificado se requiere una junta de colocación >2,50 mm. Para la colocación de Material No Rectificado se requiere una junta de colocación >4,00 mm, y además, se colocarán de forma trabada o en espiga (no se colocarán a más de 1/4 de su dimensión). *Tile joints: For the installation of Rectified Material, a tile joint >2.50 mm is required. For the installation of Not Rectified Material is necessary a tile joint >4.00 mm, and in addition, they shall be installed in a random laying or herringbone manner (they shall not be installed at more than 1/4 of their dimension).*

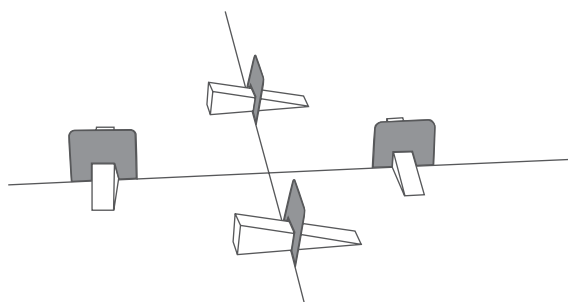
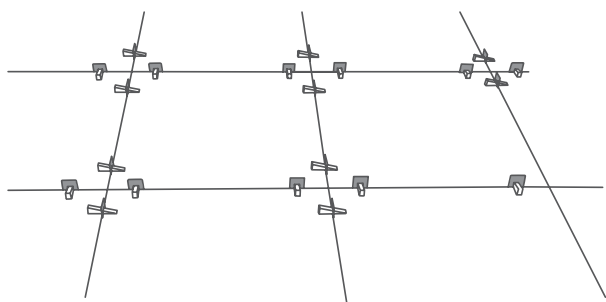

208

ELECCIÓN Y COLOCACIÓN DEL MATERIAL DE AGARRE

CHOICE AND INSTALLATION OF THE BONDING MATERIAL

El material adhesivo a utilizar será cemento cola flexible C-2 TE S2 apropiado para la instalación de pavimento de gres porcelánico.

The adhesive material to be used shall be C-2 TE S2 flexible cementitious adhesive suitable for the installation of porcelain stoneware flooring.

- C: Adhesivo cementoso. *Cementitious adhesive.*
- 2: Adhesivo mejorado. *Improved adhesive.*
- T: Adhesivo con deslizamiento reducido. *Reduced slip adhesive.*
- E: Adhesivo con tiempo abierto ampliado. *Adhesive with extended open time.*
- S2: Adhesivo altamente deformable. *Highly deformable adhesive.*



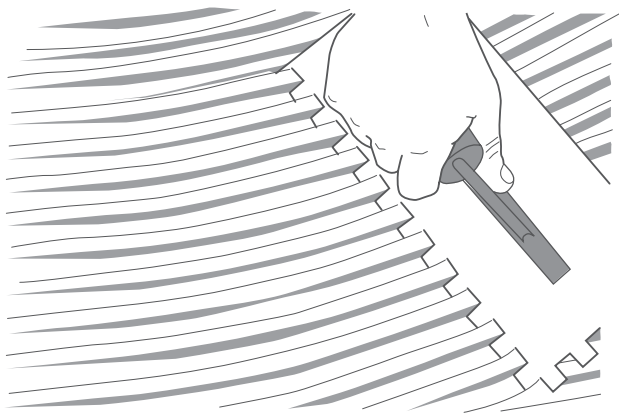

Una vez preparada la mezcla siguiendo las instrucciones del fabricante del producto, extenderemos con la ayuda de una llana dentada el cemento de agarre sobre la superficie previamente compacta y nivelada. Se deberá extender también cemento de agarre en la parte posterior de la pieza con una llana dentada, generando de esta forma un doble encolado.

—
Once the mixture has been prepared according to the product manufacturer's instructions, spread the bonding cement on the previously compacted and levelled surface with the help of a notched trowel. The bonding cement should also be spread on the back of the workpiece with a notched trowel, thus creating a double bond.

INSTALACIÓN DE LA PIEZA CERÁMICA INSTALLATION OF THE CERAMIC TILE

Con la ayuda de una maza de goma flexible se fijará la baldosa cerámica eliminando posibles burbujas de aire producidas por el material de agarre.

—
With the help of a flexible rubber mallet, the ceramic tile will be fixed, eliminating possible air bubbles produced by the bonding material.

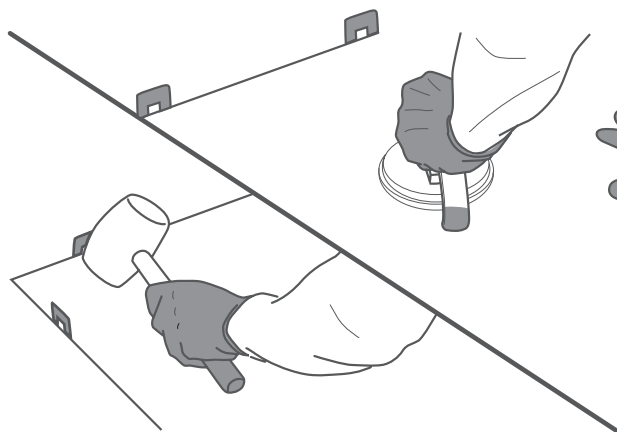

ELECCIÓN Y COLOCACIÓN DE MATERIAL DE REJUNTE

CHOICE AND INSTALLATION OF GROUT





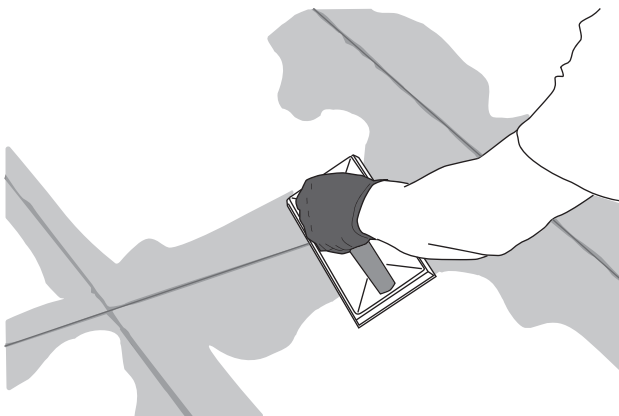





El material de rejunte a utilizar en las juntas perimetrales, juntas de colocación y juntas de partición sera rejuntado cementoso mejorado tipo CG2. Una vez preparada la mezcla, siguiendo las instrucciones del fabricante del producto, extenderemos el material de rejuntado entre la separación de las piezas y se fijará con la ayuda de una llana de rejuntado.

—
The grout material to be used in the perimeter joints, tile joints and partition joints shall be CG2 type improved cementitious grout. Once the mixture has been prepared, following the product manufacturer's instructions, spread the grout between the separation of the pieces and fix it with the help of a grout trowel.



COLORES DE JUNTA RECOMENDADOS | *RECOMMENDED GROUT COLOURS*

El color de la junta lo eliges tú. Considera esto como una recomendación.

COLECCIÓN	MAPEI	KERAKOLL	LITOKOL	SIKACERAM
 Crosscut Puro	Ultracolor Plus 100	Fugabella Color KK2	Stylegrout White 2	Blanco
 Crosscut Petra	Ultracolor Plus 130	Fugabella Color KK152	Stylegrout Ivory 2	Arena
 Crosscut Cloud	Ultracolor Plus 111	-	Stylegrout Silver 1	Perla
 Veincut Aurora	Ultracolor Plus 100	Fugabella Color KK109	Stylegrout Ivory 2	Beige
 Veincut Sahara	Ultracolor Plus 132	-	Stylegrout Beige 2	Teca
 Veincut Basalt	Ultracolor Plus 110	-	Stylegrout Grey 1	Ceniza
 Savoy Moon	Ultracolor Plus 100	Fugabella Color KK1	Stylegrout White 1	Blanco
 Savoy Desert	Ultracolor Plus 130	Fugabella Color KK152	Stylegrout Ivory 3	Arena
 Savoy Land	Ultracolor Plus 112	Fugabella Color KK4	Stylegrout Silver 2	Cemento
 Stromboli Light	Ultracolor Plus 100	Fugabella Color KK1	Stylegrout White 1	Blanco
 Stromboli Cream	Ultracolor Plus 130	Fugabella Color KK152	Stylegrout Ivory 2	Arena
 Stromboli Silver	Ultracolor Plus 112	Fugabella Color KK4	Stylegrout Silver 2	Cemento
 Cupira Hueso	Ultracolor Plus 100	Fugabella Color KK1	Stylegrout White 1	Blanco
 Cupira Marengo	Ultracolor Plus 111	Fugabella Color KK4	Stylegrout Silver 2	Perla
 Cupira Multi	Ultracolor Plus 113	-	Stylegrout Silver 3	Cemento
 Salem Clar	Ultracolor Plus 130	Fugabella Color KK152	Stylegrout Ivory 3	Arena
 Salem Dune	Ultracolor Plus 132	Fugabella Color KK8	Stylegrout Beige 1	Caramelo
 Coralina Aguada	Ultracolor Plus 130	Fugabella Color KK2	Stylegrout Ivory 2	Arena

Estos colores de junta son una sugerencia de Cerámica Mayor para rejuntos cementosos mejorados, diseñados para ser aplicados en terrazas exteriores y en zonas interiores. En interiores de piscinas, se deberá emplear un rejunte epoxídico antiácido de características equivalentes, que garanticen resistencia a la inmersión y a agentes químicos

COLORES DE JUNTA RECOMENDADOS | RECOMMENDED GROUT COLOURS

You choose the colour of the grout. Consider this a recommendation.

COLECCIÓN	MAPEI	KERAKOLL	LITOKOL	SIKACERAM
 Coralina Samaná	Ultracolor Plus 132	Fugabella Color KK109	Stylegrout Beige 1	Caramelo
 Eterna Alba	Ultracolor Plus 100	Fugabella Color KK1	Stylegrout White 1	Blanco
 Eterna Argent	Ultracolor Plus 113	Fugabella Color KK4	Stylegrout Silver 3	Cemento
 Eterna Cendra	Ultracolor Plus 114	-	Stylegrout Black 1	Antracita
 Iconic Stone	Ultracolor Plus 110	Fugabella Color KK4	Stylegrout Grey 1	Visón
 Calacatta Fresh	Ultracolor Plus 100	Fugabella Color KK1	Stylegrout White 1	Blanco
 Cements Snow	Ultracolor Plus 100	Fugabella Color KK1	Stylegrout White 1	Blanco
 Cotto Boho	Ultracolor Plus 132	Fugabella Color KK107	Stylegrout Ivory 4	Visón
 Amazonia Miel	Ultracolor Plus 141	Fugabella Color KK152	Stylegrout Beige 4	Caramelo
 Amazonia Canela	Ultracolor Plus 142	Fugabella Color KK154	Stylegrout Brown 1	Caoba
 Mizu Kai	Ultracolor Plus 168	Fugabella Color KK29	Starlike Evo Azzurro Polvere 310	Hielo
 Mizu Midori	Ultracolor Plus 174	Fugabella Color KK50	Starlike Evo Verde Salvia 400	Menta
 Mizu Shiro	Ultracolor Plus 132	Fugabella Color KK107	Starlike Evo Rosa Cipria 500	Visón
 Tropic Turqueta	Ultracolor Plus 114	-	Starlike Evo Negro Grafite 140	Antracita
 Tropic Aguamarina	Ultracolor Plus 114	-	Starlike Evo Negro Grafite 140	Antracita
 Bali Zatu	Ultracolor Plus 177	Fugabella Color KK50	Starlike Evo Verde Salvia 400	Menta
 Bali Goa	Ultracolor Plus 168	Fugabella Color KK50	Starlike Evo Grigio Piombo 120	Antracita
 Volcanic Lava	Ultracolor Plus 114	-	Starlike Evo Negro Grafite 140	Antracita

These grout colours are a suggestion from Cerámica Mayor for improved cementitious grouts, designed for use on outdoor terraces and indoor areas. In swimming pool interiors, an anti-acid epoxy grout with equivalent characteristics should be used to ensure resistance to immersion and chemical agents.

GRES PORCELÁNICO 20 MM | 20 MM PORCELAIN STONEWARE

La versatilidad es una de las grandes ventajas del gres porcelánico de 20 mm. Puede instalarse directamente sobre césped, grava, arena o como pavimento elevado (plots).

—
Versatility is one of the key advantages of 20 mm porcelain stoneware. It can be installed directly onto grass, gravel, sand, or as an elevated floor (plots).



212



SISTEMAS DE INSTALACIÓN | INSTALLATION SYSTEMS

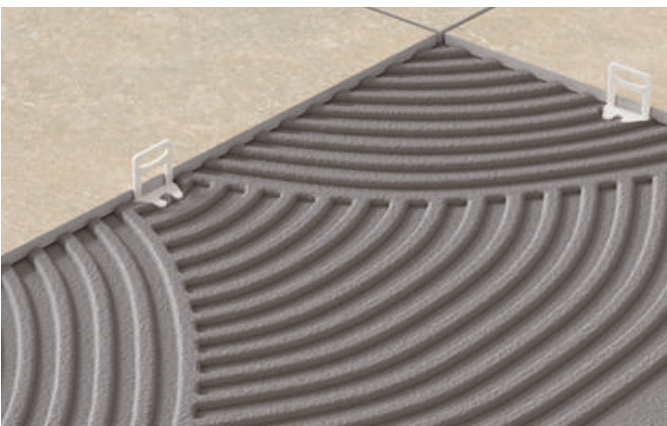

SOBRE CEMENTO *ON CONCRETE*

La colocación tradicional sobre cemento permite crear superficies transitables de alta resistencia a cargas dinámicas y concentradas: garajes, patios, aparcamientos, áreas peatonales, etc.

—
Traditional tile installation on concrete makes it possible to create walkable surfaces with high resistance to dynamic and concentrated loads: garages, patios, parking lots, pedestrian areas, etc.

SOBRE HIERBA

ON GRASS

Sobre césped permite crear pasarelas y accesos en jardines, parques o caminos.

—
On grass creates walkways and access in gardens, parks, or paths.



SOBRE GRAVA O PIEDRA

ON GRAVEL OR STONE

La colocación en seco sobre grava o piedra es un sistema rápido y limpio sin adhesivos. Permite la recolocación fácil de las piezas y es perfecto para jardines, terrazas y zonas exteriores con tránsito peatonal.

—
Dry installation on gravel or stone is a quick and clean system requiring no adhesives. It allows easy repositioning of the tiles and it's perfect for gardens, terraces, and outdoor areas with pedestrian traffic.

ELEVADA (PLOTS)

RAISED (PLOTS)

La colocación sobreelevada con plots es apta para todo tipo de suelos o superficies, facilita el drenaje y la nivelación del suelo. Ofrece una estética uniforme y oculta soportes e instalaciones.

—
Raised installation with plots is suitable for all types of surfaces, allowing drainage and floor levelling. It ensures a uniform look while concealing supports and installations.



COLOCACIÓN ELEVADA (PLOTS) | RAISED INSTALLATION (PLOTS)



La instalación de cerámica sobre plots ofrece una solución eficiente y flexible para la construcción, permitiendo una instalación rápida y una base sólida y duradera. Este sistema se adapta a diversos diseños y estilos arquitectónicos.

—
The installation of ceramic over plots offers an efficient and flexible solution for construction, allowing for quick installation and a solid, durable base. This system adapts to various designs and architectural styles.

VENTAJAS (PLOTS) | ADVANTAGES (PLOTS)



NIVELADO DE SUPERFICIES IRREGULARES

COMPENSATION FOR UNEVEN SURFACES

Los plots regulables y autonivelantes permiten crear una superficie perfectamente plana, incluso sobre superficies irregulares o con pendiente.

—
Adjustable and self-levelling pedestals help create a perfectly flat upper surface, even over uneven or sloped substrates.



DRENAJE EFICAZ DEL AGUA

EFFECTIVE WATER DRAINAGE

El sistema de juntas abiertas permite que el agua de lluvia fluya entre las piezas y se canalicé por debajo, evitando encharcamientos y mejorando la seguridad.

—
The open joint system allows rainwater to flow freely between the tiles and be channelled underneath, preventing puddles and improving safety.

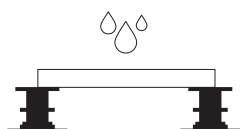



INSTALACIONES OCULTAS
CONCEALED INSTALLATIONS

El sistema elevado crea un espacio bajo el pavimento donde pueden pasar tuberías, cables u otras instalaciones técnicas de forma totalmente oculta, manteniendo una apariencia limpia y ordenada.

The raised system creates a space beneath the flooring where pipes, cables and other technical installations can run completely concealed, maintaining a clean and tidy appearance.

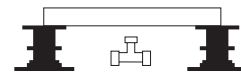

AISLAMIENTO TÉRMICO Y ACÚSTICO
THERMAL AND ACOUSTIC INSULATION

La cámara de aire entre el soporte y las baldosas contribuye a mejorar el confort térmico y reducir la transmisión del ruido. Recuerda que para un aislamiento real se necesitan capas específicas de material aislante.

The air gap between the substrate and the tiles can improve thermal and sound performance. Remember that specific layers of insulating material are required for effective insulation.

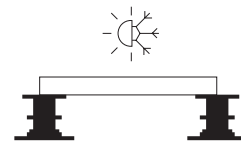

REUTILIZABLE Y SOSTENIBLE
REUSABILITY AND SUSTAINABILITY

Es un sistema modular y reversible, que permite reutilizar o reubicar los materiales con un impacto mínimo.

The system is modular and reversible, allowing materials to be reused or repositioned with minimal waste.

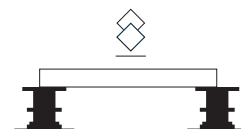

COLOCACIÓN DE PELDAÑOS

Steps Installation

Colecciones
Collections

Piezas especiales
Special pieces

Sistemas constructivos piscinas
Pool construction systems

Colocación pavimento
Flooring installation

Colocación peldaños
Steps installation

Colocación piezas
especiales piscinas
*Installation of special
pool components*

«El exterior merece lo extraordinario:
mejor diseño, mejor ejecución, mejor servicio».

*«The exterior deserves the extraordinary:
better design, better execution, better service».*

COLOCACIÓN DE PELDAÑOS | PLACEMENT OF STEPS



PLANIFICACIÓN

SETTING-OUT ON SITE

Nos aseguraremos de que las medidas de nuestro material encajan en la escalera. Debemos tener en cuenta todo tipo de juntas: estructurales, perimetrales, de dilatación, y de colocación.

—
We recommend to ensure that all the tiles fit properly at the stairs. At this point, it is important to consider all the necessary joints: expansion joints, perimeter joints, tile-to-tile joints and structural joints.

SUPERFICIE Y ENCOLADO

SURFACE AND ADHESIVE METHOD

La superficie debe estar bien conformada y seca. Eliminamos cualquier resto de suciedad. El adhesivo se extiende sobre el escalón de obra y sobre el peldaño. A continuación, colocamos el peldaño totalmente apoyado sobre la escalera.

—
The support surface should be well-formed, clean and dry. The adhesive is spread both, on the back side of the step tile and on the support. Then, the step tile should be positioned completely resting on the support.



IMPORTANTE

IMPORTANT

Para una correcta instalación de los peldaños es necesario utilizar junta elástica impermeable y cemento cola flexible. Comprobamos las piezas y ajustamos los niveles.

—
We recommend to use appropriate bonding materials: the adhesive should be high-adherence and flexible and the grouts past should be waterproof and elastic. The level should be checked and adjusted.

JUNTAS

JOINTS

Junta entre peldaños entre 6 y 10 mm.
La junta de dilatación debe hacerse cada 4.8 m.

—
*We recommend to use a tile-to-tile joint between 6 and 10 mm.
We recommend to install an expansion joint each 4.8 m.*



Escanea este QR y visualiza nuestro video de colocación de peldaños.
Scan this QR and watch our step installation video.



**EL RODAPIÉ COMO SOLUCIÓN
PARA ZANQUINES**
SKIRTING BOARD APPLICATIONS

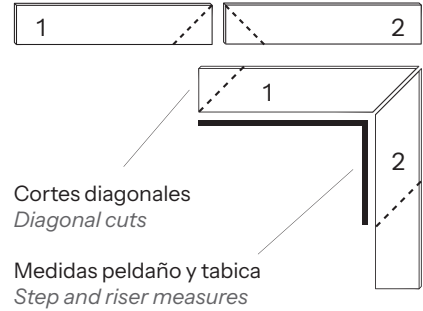

«Más que un remate. Seguridad, resistencia y diseño en una sola pieza».

—
«More than a finishing touch: safety, strength and design in a single piece».

219



CEMENTS SNOW

COLOCACIÓN PIEZAS ESPECIALES PARA PISCINAS

*Special Components
Pool Installation*

Colecciones
Collections

Piezas especiales
Special pieces

Sistemas constructivos piscinas
Pool construction systems

Colocación pavimento
Flooring installation

Colocación peldaños
Steps installation

Colocación piezas
especiales piscinas
*Installation of special
pool components*

«Más de un siglo trabajando
junto a arquitectos y distribuidores
para que los exteriores se disfruten».

*«Over a century working
alongside architects and distributors to ensure
that outdoor spaces can be enjoyed».*

COLOCACIÓN PIEZAS ESPECIALES PARA PISCINAS

INSTALLATION OF SPECIAL PIECES FOR SWIMMING POOLS

Una vez se haya ejecutado el vaso de la piscina y preparado el soporte para recibir el material cerámico, Mayor sugiere seguir los siguientes pasos para conseguir una correcta ejecución en la colocación de las piezas especiales de borde.

Once we have prepared the pool vessel, Mayor suggests the following steps to achieve a correct execution in the placement of special pieces for pool edges.

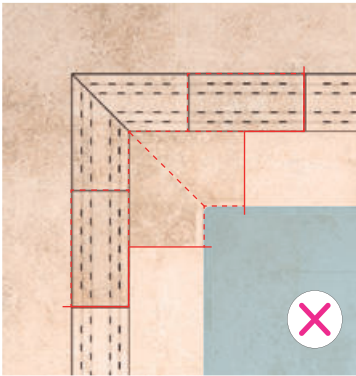

Una colocación incorrecta puede producir roturas en las piezas.

—
Incorrect alignment or placement of the pieces can cause breakages in pieces.

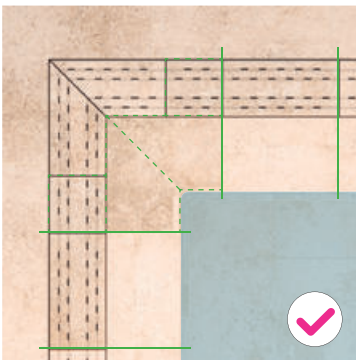

Alineación correcta de las piezas. Estas piezas se deberán de cortar y ajustar en obra.

—
Correct alignment of pieces. These pieces must be cut and adjusted on-site.

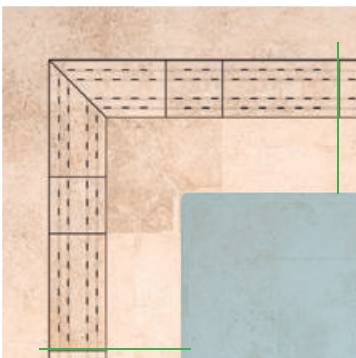

La colocación de las piezas deberá de empezar de los extremos hacia el centro de cada uno de los lados, manteniendo la linealidad de las piezas.

—
The placement of the pieces must start from the corners to the center of each side, keeping the linearity of the pieces.

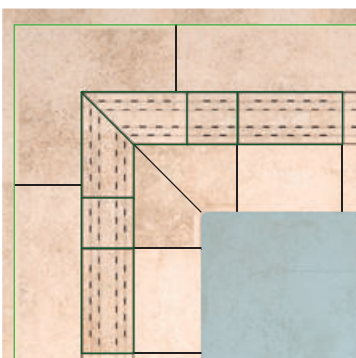

Las juntas de expansión son muy importantes en la colocación de las piezas para evitar posibles roturas. Mayor recomienda:

- Junta abierta mínima 4 mm
- Junta cerrada mínima 4 mm
- Junta de dilatación

—
The expansion joints are very important to ensure correct ceramic pieces placement and to avoid possible breakages. Mayor recommends:

- Open joint minimum 4 mm size
- Closed joint minimum 4 mm size
- Expansion joint

Escanea este QR para acceder al apartado de colocación de nuestra web y obtener más información.
For more information, scan this QR to access the placement section of our website.

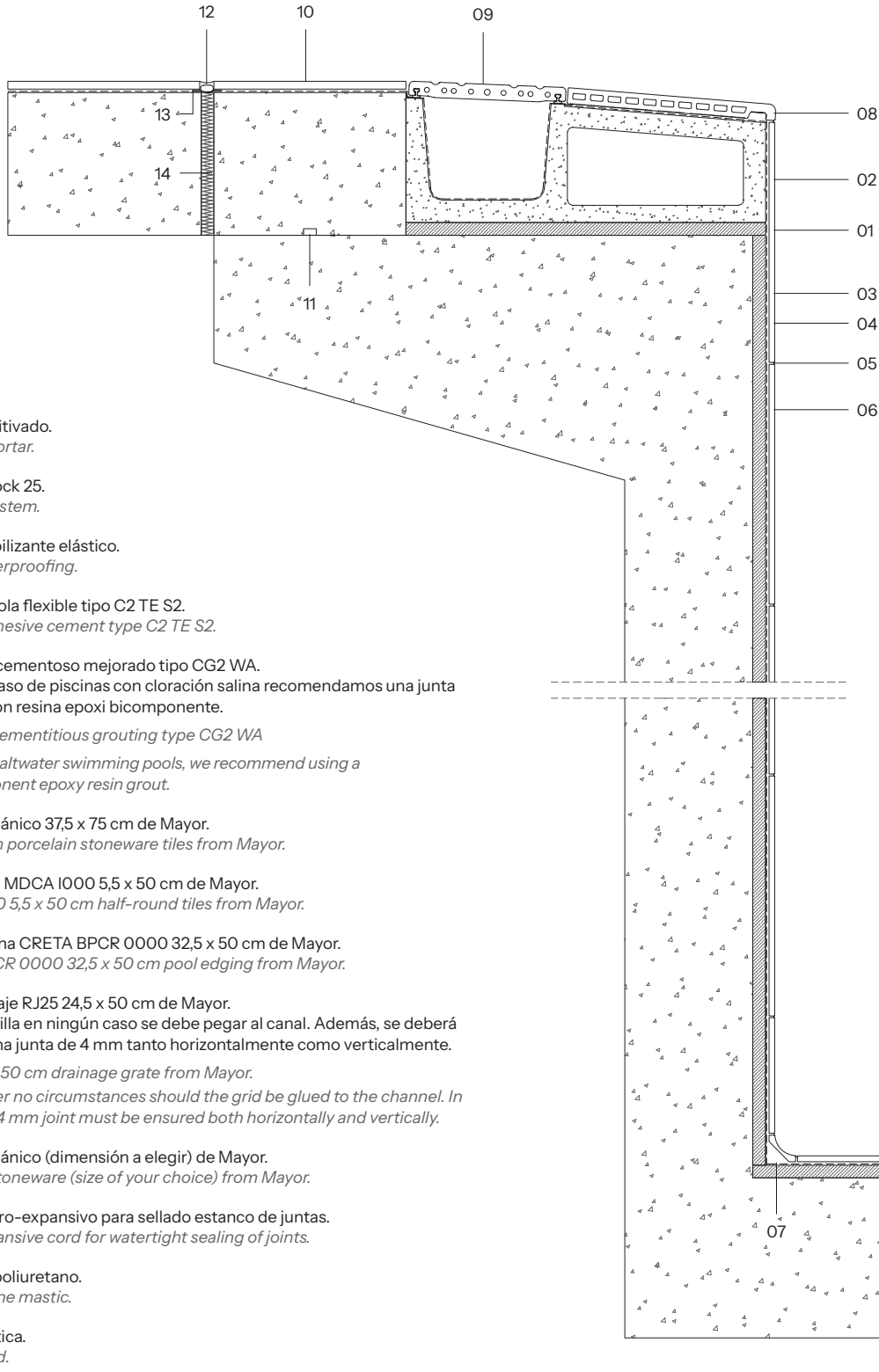

01. Mortero aditivado.
Additive Mortar.
02. Sistema Block 25.
Block 25 System.
03. Impermeabilizante elástico.
Elastic waterproofing.
04. Cemento cola flexible tipo C2 TE S2.
Flexible adhesive cement type C2 TE S2.
05. Rejuntado cementoso mejorado tipo CG2 WA.
Improved cementitious grouting type CG2 WA
**Nota: En caso de piscinas con cloración salina recomendamos una junta realizada con resina epoxi bicomponente.*
06. Gres porcelánico 37,5 x 75 cm de Mayor.
37,5 x 75 cm porcelain stoneware tiles from Mayor.
07. Media caña MDCA 1000 5,5 x 50 cm de Mayor.
MDCA 1000 5,5 x 50 cm half-round tiles from Mayor.
08. Borde piscina CRETA BPCR 0000 32,5 x 50 cm de Mayor.
CRETA BPCR 0000 32,5 x 50 cm pool edging from Mayor.
09. Rejilla drenaje RJ25 24,5 x 50 cm de Mayor.
RJ25 24,5 x 50 cm drainage grate from Mayor.
**Nota: la rejilla en ningún caso se debe pegar al canal. Además, se deberá asegurar una junta de 4 mm tanto horizontalmente como verticalmente.*
10. Gres porcelánico (dimensión a elegir) de Mayor.
Porcelain stoneware (size of your choice) from Mayor.
11. Cordón hidro-expansivo para sellado estanco de juntas.
Hydro-expansive cord for watertight sealing of joints.
12. Masilla de poliuretano.
Polyurethane mastic.
13. Banda elástica.
Elastic band.
14. Poliestireno expandido.
Expanded polystyrene.
15. Mortero para realización de soleras.
Mortar for laying screeds.

INSTALACIÓN SISTEMA **BLOCK25** PARA PISCINAS INSTALLATION OF **BLOCK25** SYSTEM FOR SWIMMING POOLS



Se realiza el hormigonado del vaso, dejando una zona de recepción para el sistema Block 25 y unas armaduras de espera para el talón posterior.

—
The concrete is poured into the tank, leaving a reception area for the Block 25 system and waiting reinforcement for the subsequent heel.

Se colocan puntos de adhesivo de base polimérica con silicona para el pegado de la junta hidro-expansiva. Sobre los puntos de adhesivo se fija un cordón hidro-expansivo para conseguir un correcto sellado.

—
Dots of polymer-based adhesive with silicone are applied for the bonding of the hydro-expansive joint. A hydro-expansive bead is fixed over the adhesive points to achieve a proper seal.



224



Para fijar el Sistema Block 25 se empleará un mortero aditivado que garantice una correcta adhesión. Con la ayuda de un láser, comprobaremos que el sistema Block 25 está correctamente nivelado. En primer lugar, colocaremos las piezas especiales de esquina.

—
To fix the Block 25 System, an additive mortar shall be used to ensure correct adhesion. With the help of a laser, we will check that the Block 25 system is correctly levelled. First, we will place the special corner pieces.

En segundo lugar, se colocarán el resto de los bloques aplicando mortero tanto en la base como en los laterales de cada uno de los bloques para que el sistema Block 25 quede totalmente instalado en todo el perímetro de la piscina.

—
Secondly, the rest of the blocks will be placed by applying mortar to both the base and the sides of each of the blocks so that the Block 25 system is completely installed around the perimeter of the pool.



Se quitan las setas de seguridad de PVC y se coloca un encofrado de madera para realizar el talón posterior.

—
The PVC safety caps are removed and a wooden formwork is put in place to make the rear heel.

Escanea este QR y visualiza el vídeo de instalación del sistema Block25
Scan this QR and view our Block25 system installation video



Se realiza el recredido de mortero adhesivo asegurándonos que el sistema Block 25 queda perfectamente alineado con el paramento vertical de la piscina.

The adhesive mortar screed is applied, ensuring that the Block 25 system is perfectly aligned with the vertical face of the swimming pool.

Se realiza la losa de hormigón de la terraza adyacente a la piscina y se impermeabiliza el vaso y el canal con dos capas de mortero flexible y 100% estanco. Posteriormente, se ejecuta la junta de dilatación alrededor de la piscina para que los movimientos de la terraza no la afecten.

The concrete slab of the terrace adjacent to the swimming pool is made and the basin and the channel are waterproofed with two layers of flexible, 100% watertight mortar. Next, the expansion joint is made around the swimming pool so that the movements of the terrace do not affect it.

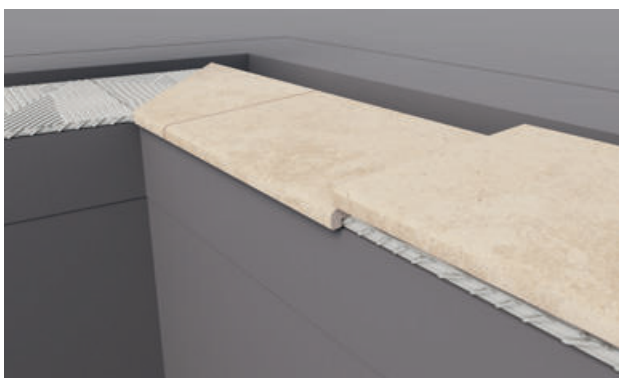
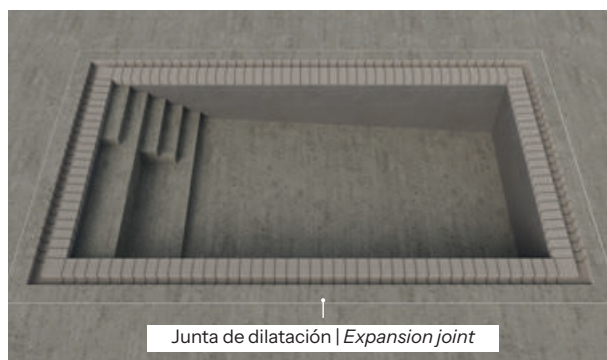

Con la ayuda de una llana dentada, aplicamos cemento cola flexible apta para gres porcelánico. Posteriormente, colocamos los bordes de piscina Mayor que encajan a la perfección con el sistema Block 25. La pieza de borde se coloca a lo largo de todo el perímetro de la piscina.

With the help of a notched trowel, we apply flexible cement glue suitable for porcelain stoneware, and then we place the pool edges by Mayor that fit perfectly with the Block 25 system. The border piece is placed along the entire perimeter of the pool.

Se colocan las rejillas de drenaje por todo el perímetro de la piscina empezando por las esquinas. Se apoyarán sobre la canal gracias al sistema de gomas patentado por la marca.

The drainage gratings are placed around the entire perimeter of the pool starting from the corners. They will rest on the channel thanks to the rubber system patented by the brand.



Finalmente, se aplica un rejuntado cementoso, y finalizada la piscina se pavimenta la terraza.

To finish, a cementitious grout is applied, and once the pool is finished, the terrace is paved.

INFORMACIÓN DEL EMBALAJE

Packing Information

Colecciones
Collections

Piezas especiales
Special pieces

Sistemas constructivos piscinas
Pool construction systems

Colocación pavimento
Flooring installation

Colocación peldaños
Steps installation

Colocación piezas
especiales piscinas
*Installation of special
pool components*

«Cada caja encierra más que cerámica:
encierra nuestra forma
de entender la excelencia».

*«Each box contains more than just ceramics:
it contains our understanding of excellence».*

DIMENSIONES DE LAS PIEZAS | *PIECES DIMENSIONS*

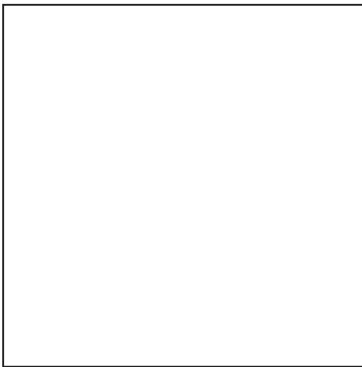

↙ ↘ 120 x 120 cm
47.2" x 47.2"

↓ ↑ 0,9 cm
0.35"

C3 R11 · C1 R9 ·

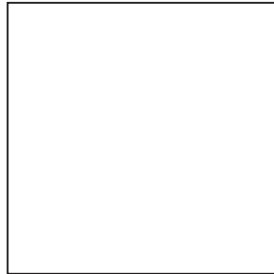

↙ ↘ 90 x 90 cm
35.4" x 35.4"

↓ ↑ 0,9 cm
0.35"

C3 R11 · C1 R9 ·

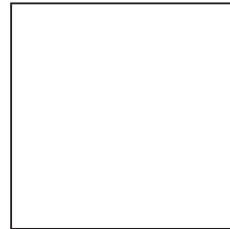

↙ ↘ 75 x 75 cm
29.5" x 29.5"

↓ ↑ 0,9 cm
0.35"

C3 R11 · C1 R9 ·

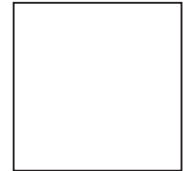

↙ ↘ 60 x 60 cm
23.6" x 23.6"

↓ ↑ 0,9 cm
0.35"

C3 R11 · C1 R9 ·



↙ ↘ 90 x 90 cm
35.4" x 35.4"

↓ ↑ 2 cm
0.78"

C3 R11 ·

228

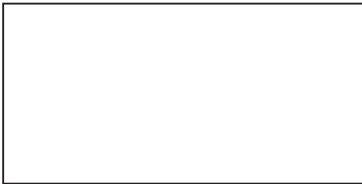

↙ ↘ 60 x 120 cm
23.6" x 47.2"

↓ ↑ 1,02 cm
0.4"

C3 R11 · C1 R9 ·



↙ ↘ 37,5 x 75 cm
14.7" x 29.5"

↓ ↑ 0,9 cm
0.35"

C3 R11 ·



↙ ↘ 30 x 120 cm
11.8" x 47.2"

↓ ↑ 0,9 cm
0.35"

C3 R11 · C1 R9 ·



↙ ↘ 30 x 60 cm
11.8" x 23.6"

↓ ↑ 0,9 cm
0.35"

C3 R11 ·



↙ ↘ 60 x 120 cm
23.6" x 47.2"

↓ ↑ 2 cm
0.78"

C3 R11 ·



↙ ↘ 20 x 120 cm
7.8" x 47.2"

↓ ↑ 0,9 cm
0.35"

C3 R11 · C1 R9 ·



↙ ↘ 14,7 x 14,7 cm
5.7" x 5.7"

↓ ↑ 0,8 cm
0.3"

C3 R11 ·



↙ ↘ 14,7 x 14,7 cm
5.7" x 5.7"

↓ ↑ 0,8 cm
0.3"

C1 R9 ·



↙ ↘ 11,5 x 23 cm
4.5" x 9"

C3 R11

INFORMACIÓN TÉCNICA DEL PAVIMENTO | *TECHNICAL INFORMATION OF THE PAVEMENT*

	Resistencia a la abrasión Resistance to surface abrasion	EN ISO 10545-7 PEI IV-V
	Resistencia a la helada Frost resistance	EN ISO 10545-12
	Resistencia al choque térmico Thermal shock resistance	EN ISO 10545-9
	Resistencia a la flexión Bending strenght	EN ISO 10545-4 >23N/mm ²
	Antideslizante OUT Antislip OUT	Deslizamiento EN 16165 Clase 3
	Antideslizante OUT Antislip OUT	EN 16165 R11
	Antideslizante OUT Antislip OUT	EN 16165 Clase C
	Resistencia a las manchas Stain resistance	EN ISO 10545-14 5
	Resistencia química Chemical resistance	EN ISO 10545-13 GA/GLA/GHA
	Resistencia al rayado OUT Scratch resistance OUT	UNE 67101 9
	Absorción de agua Water absortion	EN ISO 10545-3 <0,5%
	Resistencia al fuego Fire resistance	CLASE A1fl Sin necesidad de ensayo (Decisión 96/603/ECC Modificada)
	Resistencia al impacto Impact resistance	EN ISO 10545-5
	Tolerancia dimensional Dimensional tolerance	✓



Resistencia a la flexión
Bending strength



Resistencia a la helada
Frost resistance



Ecológico
Ecological



Resistencia química
Chemical resistance



Ignífugo
Fire resistance



Máxima resistencia al fuego y al calor
Maximum fire and heat resistance



Resistencia al rayado
Scratch resistance



Color duradero
Durable colour



Fácil limpieza y mínimo mantenimiento
Easy to clean and minimum maintenance



Resistencia al choque térmico
Thermal impact resistance



Antiestático
Antistatic



Multiformato
Multi-format



Resistencia a la abrasión
Abrasion resistance



Baja absorción
Low absorption



Piezas especiales
Special pieces



Resistencia al desgaste
Wear resistance



Durabilidad
Durability



Resistencia a los rayos UV
UV resistance



Resistencia a las manchas
Stain resistance



Fácil colocación
Easy to install



Antideslizante para exteriores
Non-slip for outdoor use

Major

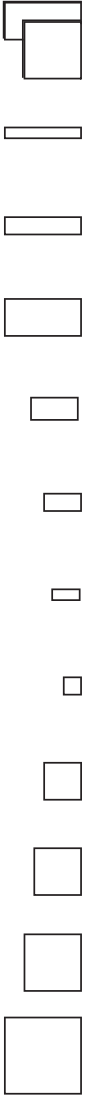

Formato Format	120x120 47.2"x47.2"	90x90 35.4"x35.4"	75x75 29.5"x29.5"	60x60 23.6"x23.6"	147x147 5.8"x5.8"	115x23 11.8"x23.6"	30x60 11.8"x23.6"	375x75 14.7"x29.5"	60x120 23.6"x47.2"	30x120 11.8"x47.2"	20x120 7.8"x47.2"	2CM 0.78"	BPOR 32.6x50	BPSA 50x120	BPMA 32.6x50	BPAR 24.6x50	REJILLAS DRAIN GRATE	PELD. 32.6x120	MDCA* TRIMS*
-------------------	------------------------	----------------------	----------------------	----------------------	----------------------	-----------------------	----------------------	-----------------------	-----------------------	-----------------------	----------------------	--------------	-----------------	----------------	-----------------	-----------------	-------------------------	-------------------	-----------------

Crosscut Piedra Stone Cloud												60x120 C3					Todas All	PELD. STEP COMP.	
Veincut Aurora Sahara Basalt					C3			C3									RJ25, RJ25 FLEX, RJ25 INV.		
Savoy Moon Desert Land					C3			C3				90x90 C3					RJ25, RJ25 FLEX, RJ25 INV.		
Stromboli Light Cream Silver				C3				C3				60x120 ST Light C3	ST Light ST Cream				Todas All	PELD. STEP COMP.	
Cupira Multi Hueso Marengo					Marengo, Multi			C3	C3=Hueso, Marengo C1=Hueso								RJ25, RJ25 FLEX		
Salem Dune Clair					Salem Clair							90x90 Salem Clair C3	Salem Clair	Salem Clair			Todas All RJ25 = Clair INV.		
Coralina Agnada Saimaná																	RJ25, RJ25 FLEX, RJ25 INV.		
Eterna Ceniza Alba																			
Iconic Stone																	RJ25, RJ25 FLEX		
Calacatta Fresh																			
Cements Snow								C3									RJ25, RJ25 FLEX		
Cotto Beho																			
Amazonia Miel Canela																	RJ25, RJ25 FLEX		
Mizu Sail Mikabi Shio						C3													
Tropic Turquesa Aguanima																			No Rectificado Slerring Board No Tabla Riser
Bali Zitui Goa					C3														COMPLETO No Rectificado Slerring Board No Tabla Riser
Volcanic Lava					C3												RJ25, RJ25 FLEX, RJ25 INV.		

Colection Collection

* No rectificado | Not rectified

Los pesos pueden sufrir variaciones

MAUI

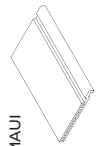

ARUBA

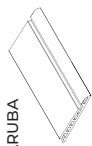

RJ25 INV



RJ25 FLEX

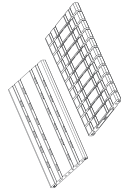

RJ20 FLEX

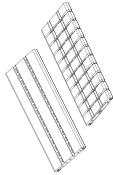

MEDIA CAÑA



SISTEMA BLOCK 25



	pulgadas	m ²	m ²	kg	kg	m ²	m ²	kg	kg	m ²	m ²	kg	kg	Crosscut	Vincut	Savay	Stromboli	Cupira	Salem	Corallina	Eterna	Iconic	Calacatta	Cements	Cotto	Amazonia	Mizu	Tropic	Ball	Volcanic			
BORDE MAUI - Ref. BPMA 0000 33x50	12,7"X19,7"	-	-	813	13,22	60	-	120	110x85x80																								
BORDE MAUI PACK ESQUINA Ref. BPMA EE00 33x50 / BPMA EIO 33x50	-	1set	-	-	-	-	-	-	-																								
BORDE CURVO MAUI Ref. BPMA RE00 33x... / BPMA RIO0 33x...	-	/radio	-	-	-	-	-	-	-																								
BORDE ARUBA - Ref. BPAR 0000 25x50	9,6"X19,7"	2	-	60	11,11	60	-	120	110x95x90																								
BORDE ARUBA PACK ESQUINA Ref. BPAR EE00 25x50 / BPAR EIO0 25x50	-	1set	-	-	-	-	-	-	-																								
BORDE CURVO ARUBA - Ref. BPAR RE00 25x... / BPAR RIO0 25x...	-	/radio	-	-	-	-	-	-	-																								
COSTE EXTRA CURVA ESPECIAL - Ref. 6624																																	
REJILLA DRENAJE RJ25 INV - Ref. RJ25 0000 INV 25x50	9,6"X19,7"	2	-	84	11,00	84	-	168	120x80x90																								
REJILLA DRENAJE RJ25 INV PACK ESQUINA Ref. RJ25 E000 INV 25x...	-	1set	-	-	-	-	-	-	-																								
REJILLA DRENAJE RJ25 - Ref. RJ25 0000 25x50	9,6"X19,7"	2	-	84	9,60	84	-	168	120x80x90																								
REJILLA DRENAJE RJ25 PACK ESQUINA Ref. RJ25 E000 25x...	-	1set	-	-	-	-	-	-	-																								
REJILLA DRENAJE CURVA RJ25 Ref. RJ25 RE00 25x... / RJ25 RIO0 25x...	-	/radio	-	-	-	-	-	-	-																								
REJILLA DRENAJE RJ25 FLEX - Ref. RJ25 FLEX 25x50	9,6"X19,7"	2	-	78	9,60	78	-	156	120x80x90																								
REJILLA DRENAJE RJ25 FLEX PACK ESQUINA Ref. RJ25 E000 FLEX 25x...	-	1set	-	-	-	-	-	-	-																								
REJILLA DRENAJE RJ20 - Ref. RJ20 0000 20x50	7,6"X19,7"	2	-	112	7,60	112	-	224	120x80x80																								
REJILLA DRENAJE RJ20 PACK ESQUINA Ref. RJ20 E000 20x...	-	1set	-	-	-	-	-	-	-																								
REJILLA DRENAJE CURVA RJ20 Ref. RJ20 RE00 20x... / RJ20 RIO0 20x...	-	/radio	-	-	-	-	-	-	-																								
REJILLA DRENAJE RJ20 FLEX - Ref. RJ20 FLEX 20x50	7,6"X19,7"	2	-	104	7,80	104	-	208	120x80x80																								
REJILLA DRENAJE RJ20 FLEX PACK ESQUINA Ref. RJ20 E000 FLEX 20x...	-	1set	-	-	-	-	-	-	-																								
MEDIA CAÑA EXTERIOR - Ref. MDCA E000 45x50	1,7"X19,7"	8	-	196	5,35	196	-	1568	120x80x90																								
MEDIA CAÑA INTERIOR - Ref. MDCA IO00 5,5x50	2,2"X19,7"	8	-	196	5,35	196	-	1568	120x80x90																								
ESCOCIA CANTONERA EXTERIOR - Ref. MDCA EE00 4,5x4,5	1,7"X17"	4	-	28	0,8	28	-	112	-																								
ESCOCIA CANTONERA INTERIOR - Ref. MDCA IO00 5,5x5,5	2,2"X22"	4	-	28	0,8	28	-	112	-																								
ESQUINA CANTONERA EXTERIOR - Ref. MDCA AE00 6,5x6,5	2,6"X26"	4	-	28	2	28	-	112	-																								
ESQUINA CANTONERA INTERIOR - Ref. MDCA AI00 6,5x6,5	2,6"X26"	4	-	28	2	28	-	112	-																								
CANTONERA TRANSICIÓN EXTERIOR - Ref. MDCA CE00 4,5x25	1,7"X9,8"	-	-	-	-	-	-	-	-																								
CANTONERA TRANSICIÓN INTERIOR - Ref. MDCA CI00 5,5x25	2,2"X9,8"	-	-	-	-	-	-	-	-																								
SISTEMA BLOCK 25 - Ref. SISTEMA.BLOCK 25 56x20	22"X7,8"	1	-	48	17	48	-	816	125x105x85																								
SISTEMA BLOCK EE 25	-	1	-	-	-	-	-	-	-																								
SISTEMA BLOCK EI 25	-	1set	-	-	-	-	-	-	-																								
SISTEMA BLOCK 25 MACIO	-	1	-	-	-	-	-	-	-																								
SISTEMA BLOCK 25 MEDIO MAGIO	-	1	-	-	-	-	-	-	-																								

(*) Bases rectificadas (👉) Salem: Clar (👇) Cupira: Multi + Marengo (👈) Cupira: Hueso + Marengo (👆) Cupira: Hueso (👉) Stromboli: Light (👇) Stromboli: Light + Cream

Weights are subject to change

MAUI

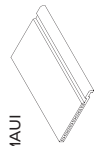

ARUBA



RJ25 INV



RJ25 FLEX

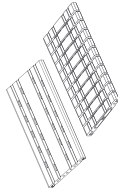

RJ20 F FLEX

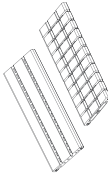

TRIM



BLOCK 25 SYSTEM



	inches	m ²	kg	kg	m ²	kg	Crosscut	Vincut	Savay	Stromboli	Cupira	Salem	Corallina	Eterna	Iconic	Calacatta	Cements	Cotto	Amazonia	Mizu	Tropic	Ball	Volcanic
MAUI EDGE - Ref. BPMA 0000 33x50	12.7" x 19.7"	2	60	13,22	813	120	110x85x80																
MAUI EDGE CORNER PACK Ref. BPMA EE00 33x50 / BPMA EI00 33x50	-	1 set	-	-	-	-	-																
MAUI CURVED EDGE Ref. BPMA RE00 33x_ / BPMA RI00 33x_	-	/radio	-	-	-	-	-																
ARUBA EDGE - Ref. BPAR 0000 25x50	9.6" x 19.7"	2	60	11,11	666	120	110x95x90																
ARUBA EDGE CORNER PACK Ref. BPAR EE00 25x50 / BPAR EI00 25x50	-	1 set	-	-	-	-	-																
ARUBA CURVED EDGE - Ref. BPAR RE00 25x_ / BPAR RI00 25x_	-	/radio	-	-	-	-	-																
EXTRA COST SPECIAL CURVE - Ref. 6624	-	-	-	-	-	-	-																
DRAIN GRATE RJ25 INV - Ref. RJ25 0000 INV 25x50	9.6" x 19.7"	2	84	1100	924	168	120x80x90																
DRAIN GRATE RJ25 INV CORNER PACK Ref. RJ25 E000 INV 25x_	-	1 set	-	-	-	-	-																
DRAIN GRATE RJ25 - Ref. RJ25 0000 25x50	9.6" x 19.7"	2	84	9,60	806	168	120x80x90																
DRAIN GRATE RJ25 CORNER PACK Ref. RJ25 E000 25x_	-	1 set	-	-	-	-	-																
CURVED DRAIN GRATE RJ25 Ref. RJ25 RE00 25x_ / RJ25 RI00 25x_	-	/radio	-	-	-	-	-																
DRAIN GRATE RJ25 FLEX - Ref. RJ25 FLEX 25x50	9.6" x 19.7"	2	78	9,60	749	156	120x80x90																
DRAIN GRATE RJ25 FLEX CORNER PACK Ref. RJ25 E000 FLEX 25x_	-	1 set	-	-	-	-	-																
DRAIN GRATE RJ20 - Ref. RJ20 0000 20x50	7.6" x 19.7"	2	112	760	851	224	120x80x80																
DRAIN GRATE RJ20 CORNER PACK Ref. RJ20 E000 20x_	-	1 set	-	-	-	-	-																
CURVED DRAIN GRATE RJ20 Ref. RJ20 RE00 20x_ / RJ20 RI00 20x_	-	/radio	-	-	-	-	-																
DRAIN GRATE RJ20 FLEX - Ref. RJ20 FLEX 20x50	7.6" x 19.7"	2	104	780	811	256	120x80x80																
DRAIN GRATE RJ20 FLEX CORNER PACK Ref. RJ20 E000 FLEX 20x_	-	1 set	-	-	-	-	-																
OUTER TRIM - Ref. MDCA E000 4.5x50	1.7" x 19.7"	8	196	5,35	1049	1568	120x80x90																
INNER TRIM - Ref. MDCA I000 5.5x50	2.2" x 19.7"	8	196	5,35	1049	1568	120x80x90																
SCOTH OUTER CORNER - Ref. MDCA EE00 4.5x4.5	1.7" x 1.7"	4	28	0,8	23	112	-																
SCOTH INNER CORNER - Ref. MDCA EI00 5.5x5.5	2.2" x 2.2"	4	28	0,8	23	112	-																
OUTER ANGLE CORNER - Ref. MDCA AE00 6.5x6.5	2.6" x 2.6"	4	28	2	56	112	-																
INNER ANGLE CORNER - Ref. MDCA AI00 6.5x6.5	2.6" x 2.6"	4	28	2	56	112	-																
EXTERNAL TRANSITION CORNER - Ref. MDCA CE00 4.5x2.5	1.7" x 9.8"	-	-	-	-	-	-																
INNER TRANSITION CORNER - Ref. MDCA CI00 5.5x2.5	2.2" x 9.8"	-	-	-	-	-	-																
BLOCK 25 SYSTEM - Ref. SISTEMA BLOCK 25 56x20	22" x 7.8"	1	48	17	816	48	125x105x85																
BLOCK EE 25 SYSTEM	-	1	-	-	-	-	-																
BLOCK EI 25 SYSTEM	-	1 set	-	-	-	-	-																
BLOCK 25 SYSTEM SOLID	-	1	-	-	-	-	-																
BLOCK 25 SYSTEM HALF SOLID	-	1	-	-	-	-	-																

(*) Bases rectificadas

(*) Bases sin rectificad

(*) Salem: Clar

(*) Cupira: Multi + Marengo

(*) Cupira: Hueso + Marengo

(*) Cupira: Hueso

(*) Stromboli: Light

(*) Stromboli: Light + Cream

COLORES DISPONIBLES | AVAILABLE COLOURS

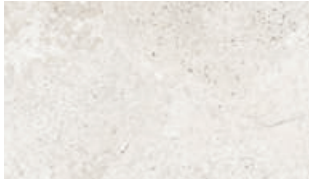

CROSSCUT PURO OUT C3 | IN C1



CROSSCUT PETRA OUT C3 | IN C1



CROSSCUT CLOUD OUT C3 | IN C1



VEINCUT AURORA OUT C3 | IN C1



VEINCUT SAHARA OUT C3 | IN C1



VEINCUT BASALT OUT C3 | IN C1



SAVOY MOON OUT C3 | IN C1



SAVOY DESSERT OUT C3 | IN C1



SAVOY LAND OUT C3 | IN C1



STROMBOLI LIGHT OUT C3 | IN C1



STROMBOLI CREAM OUT C3 | IN C1



STROMBOLI SILVER OUT C3 | IN C1

236



CUPIRA HUESO OUT C3 | IN C1

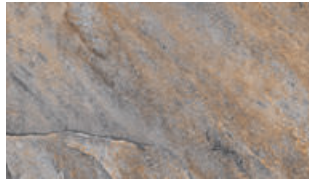

CUPIRA MULTI OUT C3



CUPIRA MARENGO OUT C3



SALEM CLAR OUT C3 | IN C1



SALEM DUNE OUT C3 | IN C1

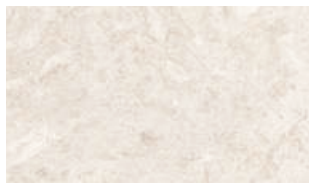

CORALINA AGUADA OUT C3 | IN C1



CORALINA SAMANÁ OUT C3 | IN C1



ETERNA ALBA OUT C3 | IN C1



ETERNA ARGENT OUT C3 | IN C1

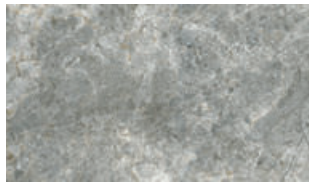

ETERNA CENDRA OUT C3 | IN C1



ICONIC STONE OUT C3 | IN C1



CALACATTA FRESH OUT C3 | IN C1



CEMENTS SNOW OUT C3 | IN C1



COTTO BOHO OUT C3 | IN C1



AMAZONIA MIEL OUT C3 | IN C1



AMAZONIA CANELA OUT C3 | IN C1



MIZU KAI OUT C3



MIZU MIDORI OUT C3



MIZU SHIRO OUT C3

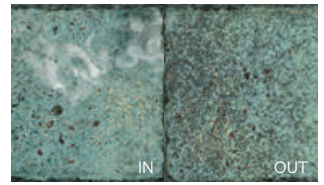

TROPIC TURQUETA OUT C3 | IN C1

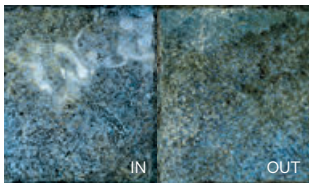

TROPIC AGUAMARINA OUT C3 | IN C1

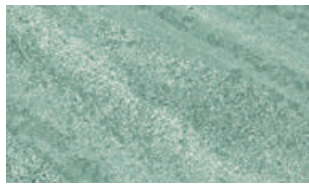

BALI ZATU OUT C3

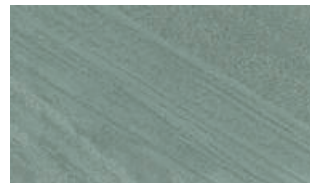

BALI GOA OUT C3

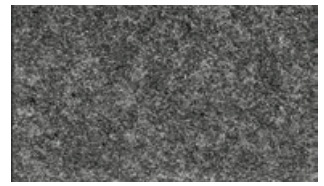

VOLCANIC LAVA OUT C3

Agradecimientos

Acknowledgements

238

Queremos dar las gracias a todos los arquitectos, interioristas, distribuidores, clientes y colaboradores que han compartido con nosotros sus proyectos e imágenes.

Este trabajo conjunto es una parte fundamental de lo que somos como marca.

—
We would like to thank all the architects, interior designers, distributors, customers and collaborators who have shared their projects and images with us.

This joint effort is a fundamental part of who we are as a brand.

Cerámica Mayor se reserva el derecho de hacer las modificaciones que considere oportunas. Debido a los procesos de impresión, los colores que aparecen en este catálogo deben considerarse aproximados, no exactos.

Toda la información de este catálogo está protegida por copyright. Está prohibida la reproducción total o parcial de los textos, imágenes y representaciones gráficas sin la autorización expresa de Cerámica Mayor.

Los ambientes que se muestran en este catálogo son sugerencias decorativas de carácter publicitario, debiéndose utilizar en la instalación real las instrucciones de colocación de Cerámica Mayor.

—

Cerámica Mayor reserves the right to make any modifications it deems appropriate. Due to printing processes, the colours that appear in this catalogue should be considered approximate, not exact.

All information in this catalogue is protected by copyright. The total or partial reproduction of the texts, images and graphic representations is prohibited without the express authorisation of Cerámica Mayor.

The settings shown in this catalogue are decorative suggestions for advertising purposes, and Cerámica Mayor's installation instructions must be followed for the actual installation.

CERÁMICA MAYOR, S.A.

Partida Planet s/n. Callosa d'en Sarrià
(03510) Alicante, España

Centro logístico:

Polígono Industrial Supoi 8, Av. Boverot 12
(12550) Almassora, Castellón
+34 965 881 175

info@ceramicamayor.com

ceramicamayor.com

Mayor

LEADING
OUTDOOR
PROJECTS